

- Output Swing Includes Both Supply Rails
- Low Noise . . . 12 nV/√Hz Typ at f = 1 kHz
- Low Input Bias Current . . . 1 pA Typ
- Fully Specified for Both Single-Supply and Split-Supply Operation
- Low Power . . . 500 μA Max
- Common-Mode Input Voltage Range Includes Negative Rail
- Low Input Offset Voltage
950 μV Max at T_A = 25°C (TLV226xA)
- Wide Supply Voltage Range
2.7 V to 8 V
- Macromodel Included
- Available in Q-Temp Automotive
HighRel Automotive Applications
Configuration Control / Print Support
Qualification to Automotive Standards

description

The TLV2262 and TLV2264 are dual and quad low voltage operational amplifiers from Texas Instruments. Both devices exhibit rail-to-rail output performance for increased dynamic range in single or split supply applications. The TLV226x family offers a compromise between the micro-power TLV225x and the ac performance of the TLC227x. It has low supply current for battery-powered applications, while still having adequate ac performance for applications that demand it. This family is fully characterized at 3 V and 5 V and is optimized for low-voltage applications. The noise performance has been dramatically improved over previous generations of CMOS amplifiers. Figure 1 depicts the low level of noise voltage for this CMOS amplifier, which has only 200 μA (typ) of supply current per amplifier.

The TLV226x, exhibiting high input impedance and low noise, are excellent for small-signal conditioning for high-impedance sources, such as piezoelectric transducers. Because of the micro-power dissipation levels combined with 3-V operation, these devices work well in hand-held monitoring and remote-sensing applications. In addition, the rail-to-rail output feature with single or split supplies makes this family a great choice when interfacing with analog-to-digital converters (ADCs). For precision applications, the TLV226xA family is available and has a maximum input offset voltage of 950 μV.

The TLV2262/4 also makes great upgrades to the TLV2332/4 in standard designs. They offer increased output dynamic range, lower noise voltage and lower input offset voltage. This enhanced feature set allows them to be used in a wider range of applications. For applications that require higher output drive and wider input voltage range, see the TLV2432 and TLV2442 devices. If your design requires single amplifiers, please see the TLV2211/21/31 family. These devices are single rail-to-rail operational amplifiers in the SOT-23 package. Their small size and low power consumption make them ideal for high density, battery-powered equipment.

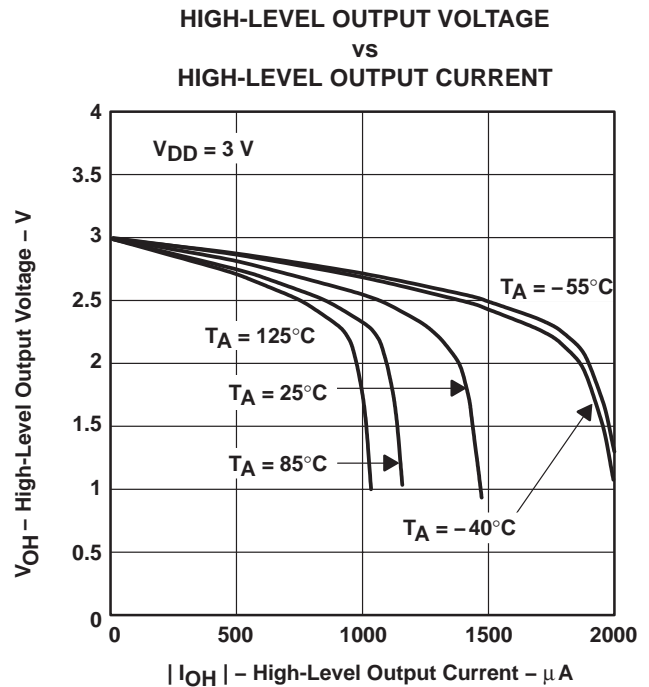

Figure 1



Please be aware that an important notice concerning availability, standard warranty, and use in critical applications of Texas Instruments semiconductor products and disclaimers thereto appears at the end of this data sheet.

Advanced LinCMOS is a trademark of Texas Instruments.

PRODUCTION DATA information is current as of publication date. Products conform to specifications per the terms of Texas Instruments standard warranty. Production processing does not necessarily include testing of all parameters.



TEXAS
INSTRUMENTS

www.BDITC.com/TI

POST OFFICE BOX 655308 • DALLAS, TEXAS 75268

Copyright © 1997–2006, Texas Instruments Incorporated
On products compliant to MIL-PRF-38535, all parameters are tested unless otherwise noted. On all other products, production processing does not necessarily include testing of all parameters.

TLV226x, TLV226xA

Advanced LinCMOS™ RAIL-TO-RAIL OPERATIONAL AMPLIFIERS

SLOS186C – FEBRUARY 1997 – REVISED AUGUST 2006

TLV2262 AVAILABLE OPTIONS

T _A	V _{IO} max AT 25°C	PACKAGED DEVICES					
		SMALL OUTLINE (D)	CHIP CARRIER (FK)	CERAMIC DIP (JG)	PLASTIC DIP (P)	TSSOP (PW)	CERAMIC FLATPACK (U)
0°C to 70°C	2.5 mV	TLV2262CD	—	—	TLV2262CP	TLV2262CPWLE	—
–40°C to 125°C	950 μV 2.5 mV	TLV2262AID TLV2262ID	— —	— —	TLV2262AIP TLV2262IP	TLV2262AIPWLE —	— —
–40°C to 125°C	950 μV 2.5 mV	TLV2262AQD TLV2262QD	— —	— —	— —	— —	— —
–55°C to 125°C	950 μV 2.5 mV	— —	TLV2262AMFK TLV2262MFK	TLV2262AMJG TLV2262MJG	— —	— —	TLV2262AMU TLV2262MU

† The D packages are available taped and reeled. Add R suffix to device type (e.g., TLV2262CDR).

‡ The PW package is available only left-end taped and reeled.

§ Chips are tested at 25°C.

¶ For the most current package and ordering information see the Package Option Addendum at the end of this document, or see the TI web site at www.ti.com.

TLV2264 AVAILABLE OPTIONS

T _A	V _{IO} max AT 25°C	PACKAGED DEVICES					
		SMALL OUTLINE (D)	CHIP CARRIER (FK)	CERAMIC DIP (J)	PLASTIC DIP (N)	TSSOP (PW)	CERAMIC FLATPACK (W)
–40°C to 125°C	950 μV 2.5 mV	TLV2264AID TLV2264ID	— —	— —	TLV2264AIN TLV2264IN	TLV2264AIPWLE —	— —
–40°C to 125°C	950 μV 2.5 mV	TLV2264AQD TLV2264QD	— —	— —	— —	— —	— —
–55°C to 125°C	950 μV 2.5 mV	— —	TLV2264AMFK TLV2264MFK	TLV2264AMJ TLV2264MJ	— —	— —	TLV2264AMW TLV2264MW

† The D packages are available taped and reeled. Add R suffix to device type (e.g., TLV2262IDR).

‡ The PW package is available only left-end taped and reeled.

§ Chips are tested at 25°C.

¶ For the most current package and ordering information see the Package Option Addendum at the end of this document, or see the TI web site at www.ti.com.

TLV226x, TLV226xA
Advanced LinCMOS™ RAIL-TO-RAIL
OPERATIONAL AMPLIFIERS

SLOS186C – FEBRUARY 1997 – REVISED AUGUST 2006

TLV2262C, TLV2262AC
TLV2262I, TLV2262AI
TLV2262Q, TLV2262AQ
D, P, OR PW PACKAGE
(TOP VIEW)

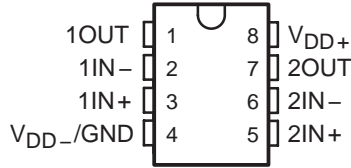

TLV2262M, TLV2262AM
JG PACKAGE
(TOP VIEW)

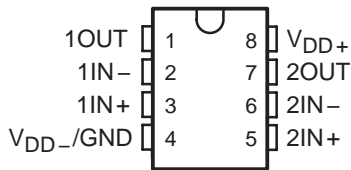

TLV2662M, TLV2262AM
U PACKAGE
(TOP VIEW)

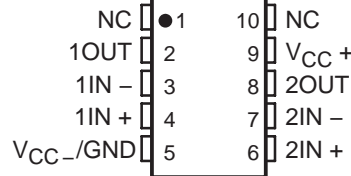

TLV2262M, TLV2262AM
FK PACKAGE
(TOP VIEW)

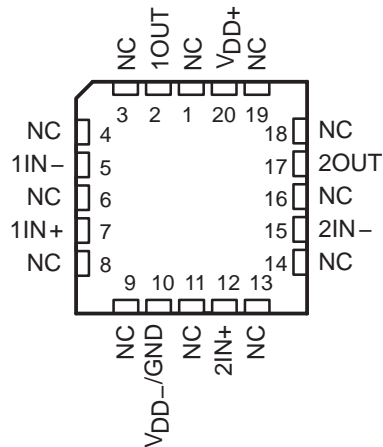

TLV2264I, TLV2264AI
TLV2264Q, TLV2264AQ
D, N, OR PW PACKAGE
(TOP VIEW)

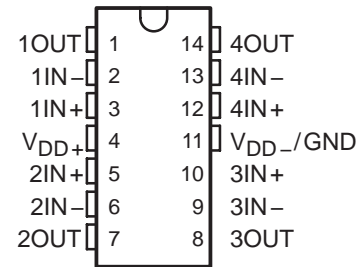

TLV2264M, TLV2264AM
J OR W PACKAGE
(TOP VIEW)

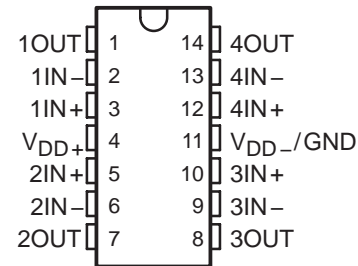

TLV2264M, TLV2264AM
FK PACKAGE
(TOP VIEW)

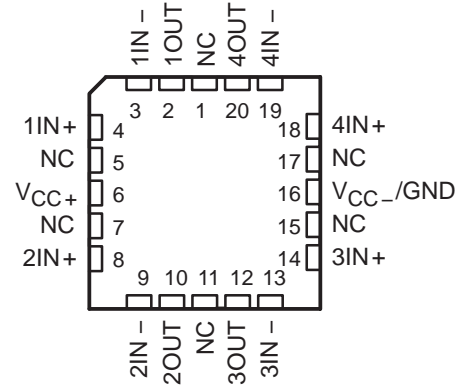

TLV226x, TLV226xA

Advanced LinCMOS™ RAIL-TO-RAIL OPERATIONAL AMPLIFIERS

SLOS186C – FEBRUARY 1997 – REVISED AUGUST 2006

equivalent schematic (each amplifier)

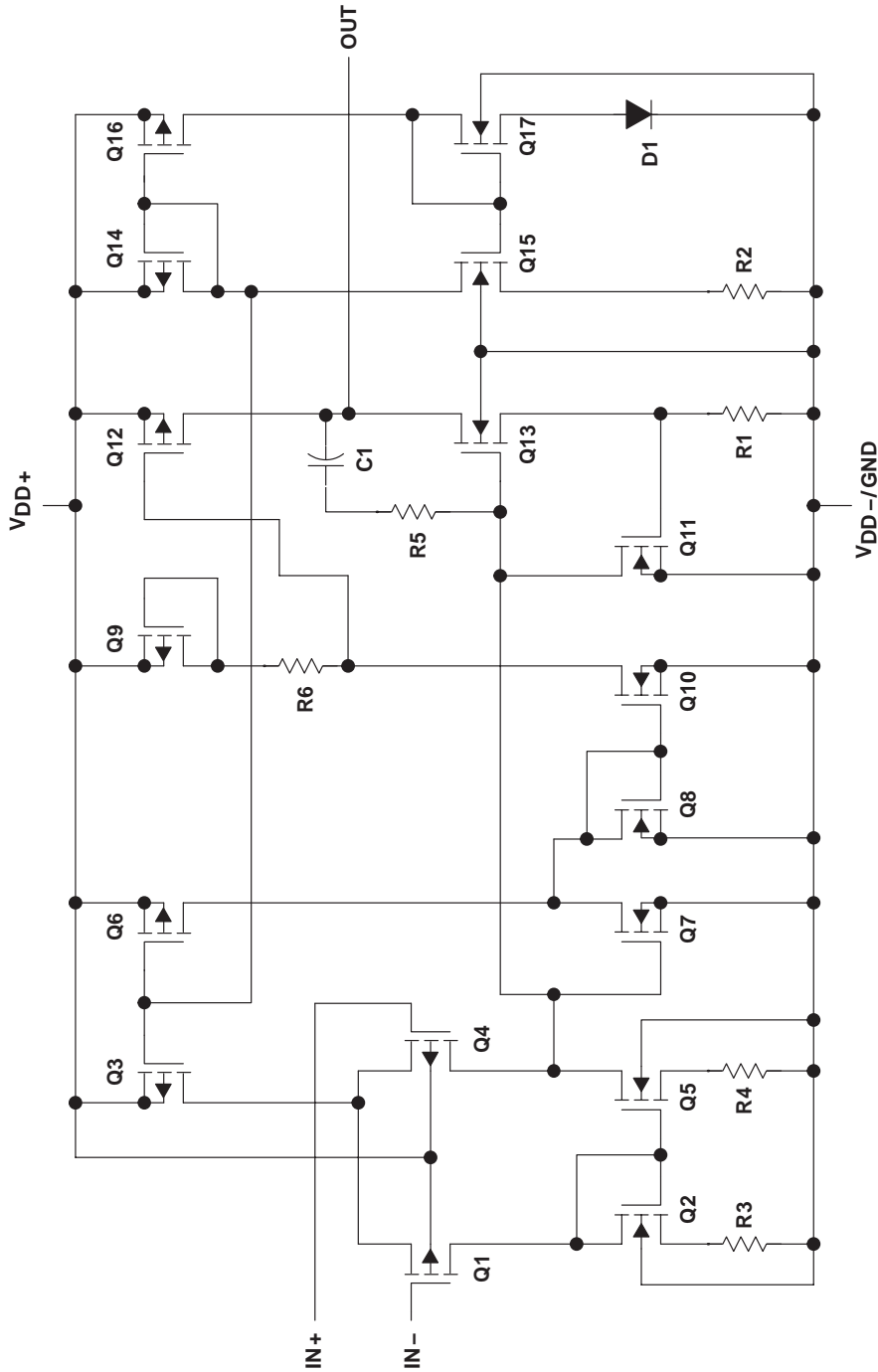

ACTUAL DEVICE COMPONENT COUNT†	
COMPONENT	TLV2252
Transistors	38
Resistors	28
Diodes	9
Capacitors	3
	TLV2254
Transistors	76
Resistors	54
Diodes	18
Capacitors	6

† Includes both amplifiers and all ESD, bias, and trim circuitry

absolute maximum ratings over operating free-air temperature range (unless otherwise noted)†

Supply voltage, V_{DD} (see Note 1)	16 V
Differential input voltage, V_{ID} (see Note 2)	$\pm V_{DD}$
Input voltage range, V_I (any input, see Note 1)	$V_{DD-} - 0.3 \text{ V to } V_{DD+}$
Input current, I_I (each input)	$\pm 5 \text{ mA}$
Output current, I_O	$\pm 50 \text{ mA}$
Total current into V_{DD+}	$\pm 50 \text{ mA}$
Total current out of V_{DD-}	$\pm 50 \text{ mA}$
Duration of short-circuit current (at or below) 25°C (see Note 3)	unlimited
Continuous total power dissipation	See Dissipation Rating Table
Operating free-air temperature range, T_A : I suffix	-40°C to 125°C
Q suffix	-40°C to 125°C
M suffix	-55°C to 125°C
Storage temperature range, T_{stg}	-65°C to 150°C

† Stresses beyond those listed under “absolute maximum ratings” may cause permanent damage to the device. These are stress ratings only, and functional operation of the device at these or any other conditions beyond those indicated under “recommended operating conditions” is not implied. Exposure to absolute-maximum-rated conditions for extended periods may affect device reliability.

- NOTES: 1. All voltage values, except differential voltages, are with respect to V_{DD-} .
 2. Differential voltages are at the noninverting input with respect to the inverting input. Excessive current flows when input is brought below $V_{DD-} - 0.3 \text{ V}$.
 3. The output may be shorted to either supply. Temperature and/or supply voltages must be limited to ensure that the maximum dissipation rating is not exceeded.

DISSIPATION RATING TABLE

PACKAGE	$T_A \leq 25^\circ\text{C}$ POWER RATING	DERATING FACTOR ABOVE $T_A = 25^\circ\text{C}$	$T_A = 85^\circ\text{C}$ POWER RATING	$T_A = 125^\circ\text{C}$ POWER RATING
D-8	725 mW	5.8 mW/°C	377 mW	145 mW
D-14	950 mW	7.6 mW/°C	494 mW	190 mW
FK	1375 mW	11.0 mW/°C	715 mW	275 mW
J	1375 mW	11.0 mW/°C	715 mW	275 mW
JG	1050 mW	8.4 mW/°C	—	210 mW
N	1150 mW	9.2 mW/°C	598 mW	—
P	1000 mW	8.0 mW/°C	520 mW	200 mW
PW-8	525 mW	4.2 mW/°C	273 mW	105 mW
PW-14	700 mW	5.6 mW/°C	364 mW	—
U	700 mW	5.5 mW/°C	—	150 mW
W	700 mW	5.5 mW/°C	370 mW	150 mW

recommended operating conditions

	I SUFFIX		Q SUFFIX		M SUFFIX		UNIT
	MIN	MAX	MIN	MAX	MIN	MAX	
Supply voltage, $V_{DD\pm}$ (see Note 1)	2.7	8	2.7	8	2.7	8	V
Input voltage range, V_I	V_{DD-}	$V_{DD+} - 1.3$	V_{DD-}	$V_{DD+} - 1.3$	V_{DD-}	$V_{DD+} - 1.3$	V
Common-mode input voltage, V_{IC}	V_{DD-}	$V_{DD+} - 1.3$	V_{DD-}	$V_{DD+} - 1.3$	V_{DD-}	$V_{DD+} - 1.3$	V
Operating free-air temperature, T_A	-40	125	-40	125	-55	125	°C

NOTE 1: All voltage values, except differential voltages, are with respect to V_{DD-} .

TLV226x, TLV226xA
Advanced LinCMOS™ RAIL-TO-RAIL
OPERATIONAL AMPLIFIERS

SLOS186C – FEBRUARY 1997 – REVISED AUGUST 2006

TLV2262I electrical characteristics at specified free-air temperature, $V_{DD} = 3\text{ V}$ (unless otherwise noted)

PARAMETER	TEST CONDITIONS	T_A †	TLV2262I			TLV2262AI			UNIT
			MIN	TYP	MAX	MIN	TYP	MAX	
V_{IO} Input offset voltage		25°C	300	2500		300	950	μV	
		Full range			3000		1500		
α_{VIO} Temperature coefficient of input offset voltage		25°C to 85°C	2			2			$\mu\text{V}/^\circ\text{C}$
Input offset voltage long-term drift (see Note 4)	$V_{DD\pm} = \pm 1.5\text{ V}$, $V_{IC} = 0$, $V_O = 0$, $R_S = 50\ \Omega$	25°C	0.003			0.003			$\mu\text{V}/\text{mo}$
I_{IO} Input offset current		25°C	0.5	60		0.5	60	pA	
		85°C	150			150			
		Full range	800			800			
I_{IB} Input bias current		25°C	1	60		1	60	pA	
		85°C	150			150			
	Full range	800			800				
V_{ICR} Common-mode input voltage range	$R_S = 50\ \Omega$, $ V_{IO} \leq 5\text{ mV}$	25°C	0 to 2	-0.3 to 2.2		0 to 2	-0.3 to 2.2	V	
		Full range	0 to 1.7		0 to 1.7				
V_{OH} High-level output voltage	$I_{OH} = -20\ \mu\text{A}$	25°C	2.99			2.99			V
	$I_{OH} = -100\ \mu\text{A}$	25°C	2.85			2.85			
	$I_{OH} = -400\ \mu\text{A}$	Full range	2.825			2.825			
		25°C	2.7	60		2.7	60		
V_{OL} Low-level output voltage	$V_{IC} = 1.5\text{ V}$, $I_{OL} = 50\ \mu\text{A}$	25°C	10			10			mV
	$V_{IC} = 1.5\text{ V}$, $I_{OL} = 500\ \mu\text{A}$	25°C	100			100			
		Full range	150			150			
	$V_{IC} = 1.5\text{ V}$, $I_{OL} = 1\text{ mA}$	25°C	200			200			
Full range		300			300				
A_{VD} Large-signal differential voltage amplification	$V_{IC} = 1.5\text{ V}$, $V_O = 1\text{ V to }2\text{ V}$	$R_L = 50\text{ k}\Omega$ ‡	25°C	60	100	60	100	V/mV	
			Full range	30			30		
		$R_L = 1\text{ M}\Omega$ ‡	25°C	100			100		
$r_{i(d)}$ Differential input resistance		25°C	10^{12}			10^{12}			Ω
$r_{i(c)}$ Common-mode input resistance		25°C	10^{12}			10^{12}			Ω
$C_{i(c)}$ Common-mode input capacitance	$f = 10\text{ kHz}$, P package	25°C	8			8			pF
z_o Closed-loop output impedance	$f = 100\text{ kHz}$, $A_V = 10$	25°C	270			270			Ω
CMRR Common-mode rejection ratio	$V_{IC} = 0\text{ to }1.7\text{ V}$, $V_O = 1.5\text{ V}$, $R_S = 50\ \Omega$	25°C	65	75		65	77	dB	
		Full range	60			60			
k_{SVR} Supply voltage rejection ratio ($\Delta V_{DD}/\Delta V_{IO}$)	$V_{DD} = 2.7\text{ V to }8\text{ V}$, $V_{IC} = V_{DD}/2$, No load	25°C	80	95		80	100	dB	
		Full range	80			80			

† Full range is -40°C to 125°C.

‡ Referenced to 1.5 V

NOTE 4: Typical values are based on the input offset voltage shift observed through 500 hours of operating life test at $T_A = 150^\circ\text{C}$ extrapolated to $T_A = 25^\circ\text{C}$ using the Arrhenius equation and assuming an activation energy of 0.96 eV.

TLV2262I electrical characteristics at specified free-air temperature, $V_{DD} = 3\text{ V}$ (unless otherwise noted) (continued)

PARAMETER	TEST CONDITIONS	T_A †	TLV2262I			TLV2262AI			UNIT
			MIN	TYP	MAX	MIN	TYP	MAX	
I_{DD} Supply current	$V_O = 1.5\text{ V}$, No load	25°C	400	500		400	500	μA	
		Full range		500			500		

† Full range is – 40°C to 125°C.

TLV2262I operating characteristics at specified free-air temperature, $V_{DD} = 3\text{ V}$

PARAMETER	TEST CONDITIONS	T_A †	TLV2262I			TLV2262AI			UNIT
			MIN	TYP	MAX	MIN	TYP	MAX	
SR Slew rate at unity gain	$V_O = 1.1\text{ V to }1.9\text{ V}$, $R_L = 50\text{ k}\Omega$ ‡, $C_L = 100\text{ pF}$ ‡	25°C	0.35	0.55		0.35	0.55	$\text{V}/\mu\text{s}$	
		Full range	0.3			0.3			
V_n Equivalent input noise voltage	$f = 10\text{ Hz}$	25°C		43			43	$\text{nV}/\sqrt{\text{Hz}}$	
	$f = 1\text{ kHz}$	25°C		12			12		
$V_{N(PP)}$ Peak-to-peak equivalent input noise voltage	$f = 0.1\text{ Hz to }1\text{ Hz}$	25°C		0.6			0.6	μV	
	$f = 0.1\text{ Hz to }10\text{ Hz}$	25°C		1			1		
I_n Equivalent input noise current		25°C		0.6			0.6	$\text{fA}/\sqrt{\text{Hz}}$	
THD + N Total harmonic distortion plus noise	$V_O = 0.5\text{ V to }2.5\text{ V}$, $f = 20\text{ kHz}$, $R_L = 50\text{ k}\Omega$ ‡	$A_V = 1$		0.03%			0.03%		
		$A_V = 10$		0.05%			0.05%		
Gain-bandwidth product	$f = 1\text{ kHz}$, $R_L = 50\text{ k}\Omega$ ‡, $C_L = 100\text{ pF}$ ‡	25°C		0.67			0.67	MHz	
B_{OM} Maximum output-swing bandwidth	$V_{O(PP)} = 1\text{ V}$, $R_L = 50\text{ k}\Omega$ ‡, $A_V = 1$, $C_L = 100\text{ pF}$ ‡	25°C		395			395	kHz	
t_s Settling time	$A_V = -1$, Step = 1 V to 2 V, $R_L = 50\text{ k}\Omega$ ‡, $C_L = 100\text{ pF}$ ‡	$T_o = 0.1\%$		5.6			5.6	μs	
		$T_o = 0.01\%$		12.5			12.5		
ϕ_m Phase margin at unity gain	$R_L = 50\text{ k}\Omega$ ‡, $C_L = 100\text{ pF}$ ‡	25°C		55°			55°		
		25°C		11			11		
Gain margin		25°C		11			11	dB	

† Full range is – 40°C to 125°C.

‡ Referenced to 1.5 V

TLV226x, TLV226xA
Advanced LinCMOS™ RAIL-TO-RAIL
OPERATIONAL AMPLIFIERS

SLOS186C – FEBRUARY 1997 – REVISED AUGUST 2006

TLV2262I electrical characteristics at specified free-air temperature, $V_{DD} = 5\text{ V}$ (unless otherwise noted)

PARAMETER	TEST CONDITIONS	T_A †	TLV2262I			TLV2262AI			UNIT
			MIN	TYP	MAX	MIN	TYP	MAX	
V_{IO} Input offset voltage		25°C	300	2500		300	950	μV	
		Full range			3000		1500		
α_{VIO} Temperature coefficient of input offset voltage		25°C to 85°C	2			2			$\mu\text{V}/^\circ\text{C}$
Input offset voltage long-term drift (see Note 4)	$V_{DD} \pm \pm 2.5\text{ V}$, $V_{IC} = 0$, $V_O = 0$, $R_S = 50\ \Omega$	25°C	0.003			0.003			$\mu\text{V}/\text{mo}$
I_{IO} Input offset current		25°C	0.5	60		0.5	60	pA	
		85°C		150		150			
		Full range		800		800			
I_{IB} Input bias current		25°C	1	60		1	60	pA	
		85°C		150		150			
Full range		800		800					
V_{ICR} Common-mode input voltage range	$ V_{IO} \leq 5\text{ mV}$, $R_S = 50\ \Omega$	25°C	0 to 4	-0.3 to 4.2		0 to 4	-0.3 to 4.2	V	
		Full range	0 to 3.5			0 to 3.5			
V_{OH} High-level output voltage	$I_{OH} = -20\ \mu\text{A}$	25°C	4.99			4.99			V
		25°C	4.85	4.94		4.85	4.94		
		Full range	4.82			4.82			
		25°C	4.7	4.85		4.7	4.85		
$I_{OH} = -100\ \mu\text{A}$	25°C	4.7			4.7			V	
	Full range	4.6			4.6				
$I_{OH} = -400\ \mu\text{A}$	$I_{OL} = 50\ \mu\text{A}$	25°C	0.01			0.01			V
		25°C	0.09	0.15		0.09	0.15		
		Full range	0.15			0.15			
		25°C	0.2	0.3		0.2	0.3		
$I_{OL} = 500\ \mu\text{A}$	25°C	0.2			0.2			V	
	Full range	0.3			0.3				
$I_{OL} = 1\text{ mA}$	$V_{IC} = 2.5\text{ V}$, $V_O = 1\text{ V to }4\text{ V}$	25°C	80	170		80	170	V/mV	
		Full range	55			55			
		25°C	550			550			
$R_L = 50\text{ k}\Omega$ ‡		25°C	550			550			V/mV
$R_L = 1\text{ M}\Omega$ ‡		25°C	550			550			
$r_{i(d)}$ Differential input resistance		25°C	10^{12}			10^{12}			Ω
$r_{i(c)}$ Common-mode input resistance		25°C	10^{12}			10^{12}			Ω
$c_{i(c)}$ Common-mode input capacitance	$f = 10\text{ kHz}$, P package	25°C	8			8			pF
z_o Closed-loop output impedance	$f = 100\text{ kHz}$, $A_V = 10$	25°C	240			240			Ω
CMRR Common-mode rejection ratio	$V_{IC} = 0\text{ to }2.7\text{ V}$, $V_O = 2.5\text{ V}$, $R_S = 50\ \Omega$	25°C	70	83		70	83	dB	
		Full range	70			70			
k_{SVR} Supply voltage rejection ratio ($\Delta V_{DD}/\Delta V_{IO}$)	$V_{DD} = 4.4\text{ V to }8\text{ V}$, $V_{IC} = V_{DD}/2$, No load	25°C	80	95		80	95	dB	
		Full range	80			80			

† Full range is -40°C to 125°C .

‡ Referenced to 2.5 V

NOTE 4: Typical values are based on the input offset voltage shift observed through 500 hours of operating life test at $T_A = 150^\circ\text{C}$ extrapolated to $T_A = 25^\circ\text{C}$ using the Arrhenius equation and assuming an activation energy of 0.96 eV.

TLV2262I electrical characteristics at specified free-air temperature, $V_{DD} = 5\text{ V}$ (unless otherwise noted) (continued)

PARAMETER	TEST CONDITIONS	T_A †	TLV2262I			TLV2262AI			UNIT
			MIN	TYP	MAX	MIN	TYP	MAX	
I_{DD} Supply current	$V_O = 2.5\text{ V}$, No load	25°C		400	500		400	500	μA
		Full range			500			500	

† Full range is – 40°C to 125°C.

TLV2262I operating characteristics at specified free-air temperature, $V_{DD} = 5\text{ V}$

PARAMETER	TEST CONDITIONS	T_A †	TLV2262I			TLV2262AI			UNIT
			MIN	TYP	MAX	MIN	TYP	MAX	
SR Slew rate at unity gain	$V_O = 1.5\text{ V to }3.5\text{ V}$, $R_L = 50\text{ k}\Omega$ ‡, $C_L = 100\text{ pF}$ ‡	25°C	0.35	0.55		0.35	0.55		$\text{V}/\mu\text{s}$
		Full range	0.3			0.3			
V_n Equivalent input noise voltage	$f = 10\text{ Hz}$ $f = 1\text{ kHz}$	25°C		40			40		$\text{nV}/\sqrt{\text{Hz}}$
		25°C		12			12		
$V_{N(PP)}$ Peak-to-peak equivalent input noise voltage	$f = 0.1\text{ Hz to }1\text{ Hz}$ $f = 0.1\text{ Hz to }10\text{ Hz}$	25°C		0.7			0.7		μV
		25°C		1.3			1.3		
I_n Equivalent input noise current		25°C		0.6			0.6	$\text{fA}/\sqrt{\text{Hz}}$	
THD + N Total harmonic distortion plus noise	$V_O = 0.5\text{ V to }2.5\text{ V}$, $f = 20\text{ kHz}$, $R_L = 50\text{ k}\Omega$ ‡	25°C		$A_V = 1$		0.017%		0.017%	
				$A_V = 10$		0.03%		0.03%	
Gain-bandwidth product	$f = 50\text{ kHz}$, $C_L = 100\text{ pF}$ ‡	25°C			0.71			0.71	MHz
BOM Maximum output-swing bandwidth	$V_{O(PP)} = 2\text{ V}$, $R_L = 50\text{ k}\Omega$ ‡	25°C			185			185	kHz
t_s Settling time	$A_V = -1$, Step = 0.5 V to 2.5 V, $R_L = 50\text{ k}\Omega$ ‡, $C_L = 100\text{ pF}$ ‡	25°C		To 0.1%		6.4		6.4	μs
				To 0.01%		14.1		14.1	
ϕ_m Phase margin at unity gain	$R_L = 50\text{ k}\Omega$ ‡, $C_L = 100\text{ pF}$ ‡	25°C			56°			56°	
Gain margin		25°C			11			11	dB

† Full range is – 40°C to 125°C.

‡ Referenced to 2.5 V

TLV226x, TLV226xA Advanced LinCMOS™ RAIL-TO-RAIL OPERATIONAL AMPLIFIERS

SLOS186C – FEBRUARY 1997 – REVISED AUGUST 2006

TLV2264I electrical characteristics at specified free-air temperature, $V_{DD} = 3\text{ V}$ (unless otherwise noted)

PARAMETER	TEST CONDITIONS	T_A †	TLV2264I			TLV2264AI			UNIT
			MIN	TYP	MAX	MIN	TYP	MAX	
V_{IO} Input offset voltage		25°C	300	2500		300	950	μV	
		Full range			3000		1500		
α_{VIO} Temperature coefficient of input offset voltage		25°C to 85°C	2			2			$\mu\text{V}/^\circ\text{C}$
Input offset voltage long-term drift (see Note 4)	$V_{DD\pm} = \pm 1.5\text{ V}$, $V_{IC} = 0$, $V_O = 0$, $R_S = 50\ \Omega$	25°C	0.003			0.003			$\mu\text{V}/\text{mo}$
I_{IO} Input offset current		25°C	0.5	60		0.5	60	pA	
		85°C	150			150			
		Full range	800			800			
I_{IB} Input bias current		25°C	1	60		1	60	pA	
		85°C	150			150			
Full range	800			800					
V_{ICR} Common-mode input voltage range	$R_S = 50\ \Omega$, $ V_{IO} \leq 5\text{ mV}$	25°C	0 to 2	-0.3 to 2.2		0 to 2	-0.3 to 2.2	V	
		Full range	0 to 1.7		0 to 1.7				
V_{OH} High-level output voltage	$I_{OH} = -20\ \mu\text{A}$	25°C	2.99			2.99			V
	$I_{OH} = -100\ \mu\text{A}$	25°C	2.85			2.85			
		Full range	2.825			2.825			
	$I_{OH} = -400\ \mu\text{A}$	25°C	2.7			2.7			
Full range		2.65			2.65				
V_{OL} Low-level output voltage	$V_{IC} = 1.5\text{ V}$, $I_{OL} = 50\ \mu\text{A}$	25°C	10			10			mV
		25°C	100			100			
	$V_{IC} = 1.5\text{ V}$, $I_{OL} = 500\ \mu\text{A}$	Full range	150			150			
		$V_{IC} = 1.5\text{ V}$, $I_{OL} = 1\text{ mA}$	25°C	200			200		
Full range	300			300					
A_{VD} Large-signal differential voltage amplification	$V_{IC} = 1.5\text{ V}$, $V_O = 1\text{ to }2\text{ V}$	$R_L = 50\ \text{k}\Omega$ ‡	25°C	60	100		60	100	V/mV
			Full range	30			30		
		$R_L = 1\ \text{M}\Omega$ ‡	25°C	100			100		
$r_{i(d)}$ Differential input resistance		25°C	10^{12}			10^{12}			Ω
$r_{i(c)}$ Common-mode input resistance		25°C	10^{12}			10^{12}			Ω
$c_{i(c)}$ Common-mode input capacitance	$f = 10\text{ kHz}$, N package	25°C	8			8			pF
z_o Closed-loop output impedance	$f = 100\text{ kHz}$, $A_V = 10$	25°C	270			270			Ω
CMRR Common-mode rejection ratio	$V_{IC} = 0\text{ to }1.7\text{ V}$, $V_O = 1.5\text{ V}$, $R_S = 50\ \Omega$	25°C	65	75		65	77	dB	
		Full range	60			60			
k_{SVR} Supply voltage rejection ratio ($\Delta V_{DD}/\Delta V_{IO}$)	$V_{DD} = 2.7\text{ V to }8\text{ V}$, $V_{IC} = V_{DD}/2$, No load	25°C	80	95		80	100	dB	
		Full range	80			80			

† Full range is -40°C to 125°C .

‡ Referenced to 1.5 V

NOTE 4: Typical values are based on the input offset voltage shift observed through 500 hours of operating life test at $T_A = 150^\circ\text{C}$ extrapolated to $T_A = 25^\circ\text{C}$ using the Arrhenius equation and assuming an activation energy of 0.96 eV.

TLV2264I electrical characteristics at specified free-air temperature, $V_{DD} = 3\text{ V}$ (unless otherwise noted) (continued)

PARAMETER	TEST CONDITIONS	T_A †	TLV2264I			TLV2264AI			UNIT
			MIN	TYP	MAX	MIN	TYP	MAX	
I_{DD}	Supply current (four amplifiers)	$V_O = 1.5\text{ V}$, No load	25°C	0.8	1	0.8	1	mA	
			Full range		1		1		

† Full range is – 40°C to 125°C.

TLV2264I operating characteristics at specified free-air temperature, $V_{DD} = 3\text{ V}$

PARAMETER	TEST CONDITIONS	T_A †	TLV2264I			TLV2264AI			UNIT
			MIN	TYP	MAX	MIN	TYP	MAX	
SR	Slew rate at unity gain $V_O = 0.7\text{ V to }1.7\text{ V}$, $R_L = 50\text{ k}\Omega$ ‡, $C_L = 100\text{ pF}$ ‡	25°C	0.35	0.55	0.35	0.55	$\text{V}/\mu\text{s}$		
		Full range	0.3		0.3				
V_n	Equivalent input noise voltage $f = 10\text{ Hz}$ $f = 1\text{ kHz}$	25°C		43		43	$\text{nV}/\sqrt{\text{Hz}}$		
		25°C		12		12			
$V_{N(PP)}$	Peak-to-peak equivalent input noise voltage $f = 0.1\text{ Hz to }1\text{ Hz}$ $f = 0.1\text{ Hz to }10\text{ Hz}$	25°C		0.6		0.6	μV		
		25°C		1		1			
I_n	Equivalent input noise current	25°C		0.6		0.6	$\text{fA}/\sqrt{\text{Hz}}$		
THD + N	Total harmonic distortion plus noise $V_O = 0.5\text{ V to }2.5\text{ V}$, $f = 20\text{ kHz}$, $R_L = 50\text{ k}\Omega$ ‡	$A_V = 1$	25°C		0.03%		0.03%		
		$A_V = 10$	25°C		0.05%		0.05%		
	Gain-bandwidth product $f = 1\text{ kHz}$, $C_L = 100\text{ pF}$ ‡	$R_L = 50\text{ k}\Omega$ ‡	25°C		0.67		0.67	MHz	
B_{OM}	Maximum output-swing bandwidth $V_{O(PP)} = 1\text{ V}$, $R_L = 50\text{ k}\Omega$ ‡	$A_V = 1$, $C_L = 100\text{ pF}$ ‡	25°C		395		395	kHz	
t_s	Settling time $A_V = -1$, Step = 1 V to 2 V, $R_L = 50\text{ k}\Omega$ ‡, $C_L = 100\text{ pF}$ ‡	To 0.1%	25°C		5.6		5.6	μs	
		To 0.01%			12.5		12.5		
ϕ_m	Phase margin at unity gain $R_L = 50\text{ k}\Omega$ ‡, $C_L = 100\text{ pF}$ ‡	25°C		55°		55°			
		25°C		11		11		dB	
	Gain margin	25°C		11		11	dB		

† Full range is – 40°C to 125°C.

‡ Referenced to 1.5 V

TLV226x, TLV226xA Advanced LinCMOS™ RAIL-TO-RAIL OPERATIONAL AMPLIFIERS

SLOS186C – FEBRUARY 1997 – REVISED AUGUST 2006

TLV2264I electrical characteristics at specified free-air temperature, $V_{DD} = 5\text{ V}$ (unless otherwise noted)

PARAMETER	TEST CONDITIONS	T_A †	TLV2264I			TLV2264AI			UNIT
			MIN	TYP	MAX	MIN	TYP	MAX	
V_{IO} Input offset voltage		25°C	300	2500		300	950	μV	
		Full range			3000		1500		
α_{VIO} Temperature coefficient of input offset voltage		25°C to 85°C	2			2			$\mu\text{V}/^\circ\text{C}$
Input offset voltage long-term drift (see Note 4)	$V_{DD\pm} = \pm 2.5\text{ V}$, $V_{IC} = 0$, $V_O = 0$, $R_S = 50\ \Omega$	25°C	0.003			0.003			$\mu\text{V}/\text{mo}$
I_{IO} Input offset current		25°C	0.5	60		0.5	60	pA	
		85°C		150		150			
		Full range		800		800			
I_{IB} Input bias current		25°C	1	60		1	60	pA	
		85°C		150		150			
	Full range		800		800				
V_{ICR} Common-mode input voltage range	$ V_{IO} \leq 5\text{ mV}$, $R_S = 50\ \Omega$	25°C	0 to 4	-0.3 to 4.2		0 to 4	-0.3 to 4.2	V	
		Full range	0 to 3.5		0 to 3.5				
V_{OH} High-level output voltage	$I_{OH} = -20\ \mu\text{A}$	25°C	4.99		4.99		V		
		25°C	4.85	4.94	4.85	4.94			
		Full range	4.82		4.82				
		25°C	4.7	4.85	4.7	4.85			
V_{OL} Low-level output voltage	$V_{IC} = 2.5\text{ V}$, $I_{OL} = -400\ \mu\text{A}$	25°C	0.01		0.01		V		
		25°C	0.09	0.15	0.09	0.15			
		Full range	0.15		0.15				
		25°C	0.2	0.3	0.2	0.3			
A_{VD} Large-signal differential voltage amplification	$V_{IC} = 2.5\text{ V}$, $V_O = 1\text{ V to }4\text{ V}$	$R_L = 50\ \text{k}\Omega$ ‡	25°C	80	170	80	170	V/mV	
			Full range	55		55			
		$R_L = 1\ \text{M}\Omega$ ‡	25°C	550		550			
			Full range	0.3		0.3			
$r_{i(d)}$ Differential input resistance		25°C	10^{12}			10^{12}	Ω		
$r_{i(c)}$ Common-mode input resistance		25°C	10^{12}			10^{12}	Ω		
$C_{i(c)}$ Common-mode input capacitance	$f = 10\ \text{kHz}$, N package	25°C	8			8	pF		
z_o Closed-loop output impedance	$f = 100\ \text{kHz}$, $A_V = 10$	25°C	240			240	Ω		
CMRR Common-mode rejection ratio	$V_{IC} = 0\text{ to }2.7\text{ V}$, $V_O = 2.5\text{ V}$, $R_S = 50\ \Omega$	25°C	70	83		70	83	dB	
		Full range	70		70				
k_{SVR} Supply voltage rejection ratio ($\Delta V_{DD}/\Delta V_{IO}$)	$V_{DD} = 4.4\text{ V to }8\text{ V}$, $V_{IC} = V_{DD}/2$, No load	25°C	80	95		80	95	dB	
		Full range	80		80				

† Full range is -40°C to 125°C .

‡ Referenced to 2.5 V

NOTE 4: Typical values are based on the input offset voltage shift observed through 500 hours of operating life test at $T_A = 150^\circ\text{C}$ extrapolated to $T_A = 25^\circ\text{C}$ using the Arrhenius equation and assuming an activation energy of 0.96 eV.

TLV2264I electrical characteristics at specified free-air temperature, $V_{DD} = 5\text{ V}$ (unless otherwise noted) (continued)

PARAMETER	TEST CONDITIONS	T_A †	TLV2264I			TLV2264AI			UNIT
			MIN	TYP	MAX	MIN	TYP	MAX	
I_{DD}	Supply current (four amplifiers)	$V_O = 2.5\text{ V}$, No load	25°C	0.8	1	0.8	1	mA	
			Full range		1		1		

† Full range is – 40°C to 125°C.

TLV2264I operating characteristics at specified free-air temperature, $V_{DD} = 5\text{ V}$

PARAMETER	TEST CONDITIONS	T_A †	TLV2264I			TLV2264AI			UNIT	
			MIN	TYP	MAX	MIN	TYP	MAX		
SR	Slew rate at unity gain $V_O = 1.4\text{ V to }2.6\text{ V}$, $C_L = 100\text{ pF}‡$	$R_L = 50\text{ k}\Omega‡$	25°C	0.35	0.55	0.35	0.55	V/ μs		
			Full range	0.3		0.3				
V_n	Equivalent input noise voltage	$f = 10\text{ Hz}$	25°C	40			40			nV/ $\sqrt{\text{Hz}}$
			$f = 1\text{ kHz}$	12			12			
$V_{N(PP)}$	Peak-to-peak equivalent input noise voltage	$f = 0.1\text{ Hz to }1\text{ Hz}$	25°C	0.7			0.7			μV
		$f = 0.1\text{ Hz to }10\text{ Hz}$	25°C	1.3			1.3			
I_n	Equivalent input noise current		25°C	0.6			0.6			fA/ $\sqrt{\text{Hz}}$
THD + N	Total harmonic distortion plus noise $V_O = 0.5\text{ V to }2.5\text{ V}$, $f = 20\text{ kHz}$, $R_L = 50\text{ k}\Omega‡$	$A_V = 1$	25°C	0.017%			0.017%			
		$A_V = 10$		0.03%			0.03%			
	Gain-bandwidth product $f = 50\text{ kHz}$, $C_L = 100\text{ pF}‡$	$R_L = 50\text{ k}\Omega‡$	25°C	0.71			0.71			MHz
BOM	Maximum output-swing bandwidth $V_{O(PP)} = 2\text{ V}$, $R_L = 50\text{ k}\Omega‡$	$A_V = 1$, $C_L = 100\text{ pF}‡$	25°C	185			185			kHz
t_s	Settling time $A_V = -1$, Step = 0.5 V to 2.5 V, $R_L = 50\text{ k}\Omega‡$, $C_L = 100\text{ pF}‡$	$T_o = 0.1\%$	25°C	6.4			6.4			μs
		$T_o = 0.01\%$		14.1			14.1			
ϕ_m	Phase margin at unity gain $R_L = 50\text{ k}\Omega‡$	$C_L = 100\text{ pF}‡$	25°C	56°			56°			
	Gain margin		25°C	11			11			

† Full range is – 40°C to 125°C.

‡ Referenced to 2.5 V

TLV226x, TLV226xA Advanced LinCMOS™ RAIL-TO-RAIL OPERATIONAL AMPLIFIERS

SLOS186C – FEBRUARY 1997 – REVISED AUGUST 2006

TLV2262Q and TLV2262M electrical characteristics at specified free-air temperature, $V_{DD} = 3\text{ V}$ (unless otherwise noted)

PARAMETER	TEST CONDITIONS	T_A †	TLV2262Q, TLV2262M			TLV2262AQ, TLV2262AM			UNIT	
			MIN	TYP	MAX	MIN	TYP	MAX		
V_{IO} Input offset voltage		25°C	300	2500		300	950	μV		
		Full range			3000		1500			
α_{VIO} Temperature coefficient of input offset voltage		25°C to 125°C	2			2			$\mu\text{V}/^\circ\text{C}$	
Input offset voltage long-term drift (see Note 4)	$V_{DD\pm} = \pm 1.5\text{ V}$, $V_{IC} = 0$, $V_O = 0$, $R_S = 50\ \Omega$	25°C	0.003			0.003			$\mu\text{V}/\text{mo}$	
I_{IO} Input offset current		25°C	0.5	60		0.5	60	pA		
		125°C		800		800				
I_{IB} Input bias current		25°C	1	60		1	60	pA		
		125°C		800		800				
V_{ICR} Common-mode input voltage range	$R_S = 50\ \Omega$, $ V_{IO} \leq 5\text{ mV}$	25°C	0 to 2	-0.3 to 2.2		0 to 2	-0.3 to 2.2	V		
		Full range	0 to 1.7			0 to 1.7				
V_{OH} High-level output voltage	$I_{OH} = -20\ \mu\text{A}$	25°C	2.99			2.99			V	
	$I_{OH} = -100\ \mu\text{A}$	25°C	2.85			2.85				
	$I_{OH} = -400\ \mu\text{A}$	Full range	2.82			2.82				
		25°C	2.7			2.7				
V_{OL} Low-level output voltage	$V_{IC} = 1.5\text{ V}$, $I_{OL} = 50\ \mu\text{A}$	25°C	10			10			mV	
	$V_{IC} = 1.5\text{ V}$, $I_{OL} = 500\ \mu\text{A}$	25°C	100	150		100	150			
		Full range	165			165				
	$V_{IC} = 1.5\text{ V}$, $I_{OL} = 1\text{ mA}$	25°C	200	300		200	300			
A_{VD} Large-signal differential voltage amplification	$V_{IC} = 1.5\text{ V}$, $V_O = 1\text{ V to } 2\text{ V}$	$R_L = 50\ \text{k}\Omega$ ‡	25°C	60	100		60	100	V/mV	
		$R_L = 1\ \text{M}\Omega$ ‡	Full range	25			25			
			25°C	100			100			
$r_{i(d)}$ Differential input resistance		25°C	10^{12}			10^{12}			Ω	
$r_{i(c)}$ Common-mode input resistance		25°C	10^{12}			10^{12}			Ω	
$C_{i(c)}$ Common-mode input capacitance	$f = 10\text{ kHz}$, P package	25°C	8			8			pF	
z_o Closed-loop output impedance	$f = 100\text{ kHz}$, $A_V = 10$	25°C	270			270			Ω	
CMRR Common-mode rejection ratio	$V_{IC} = 0\text{ to } 1.7\text{ V}$, $V_O = 1.5\text{ V}$, $R_S = 50\ \Omega$	25°C	65	75		65	77	dB		
		Full range	60			60				
k_{SVR} Supply voltage rejection ratio ($\Delta V_{DD}/\Delta V_{IO}$)	$V_{DD} = 2.7\text{ V to } 8\text{ V}$, $V_{IC} = V_{DD}/2$, No load	25°C	80	95		80	100	dB		
		Full range	80			80				

† Full range is -40°C to 125°C for Q level part, -55°C to 125°C for M level part.

‡ Referenced to 1.5 V

NOTE 4: Typical values are based on the input offset voltage shift observed through 500 hours of operating life test at $T_A = 150^\circ\text{C}$ extrapolated to $T_A = 25^\circ\text{C}$ using the Arrhenius equation and assuming an activation energy of 0.96 eV.

TLV2262Q and TLV2262M electrical characteristics at specified free-air temperature, $V_{DD} = 3\text{ V}$ (unless otherwise noted) (continued)

PARAMETER	TEST CONDITIONS	T_A †	TLV2262Q, TLV2262M			TLV2262AQ, TLV2262AM			UNIT
			MIN	TYP	MAX	MIN	TYP	MAX	
I_{DD} Supply current	$V_O = 1.5\text{ V}$, No load	25°C	400	500		400	500	μA	
		Full range		500		500			

† Full range is -40°C to 125°C for Q level part, -55°C to 125°C for M level part.

TLV2262Q and TLV2262M operating characteristics at specified free-air temperature, $V_{DD} = 3\text{ V}$

PARAMETER	TEST CONDITIONS	T_A †	TLV2262Q, TLV2262M			TLV2262AQ, TLV2262AM			UNIT
			MIN	TYP	MAX	MIN	TYP	MAX	
SR Slew rate at unity gain	$V_O = 0.5\text{ V}$ to 1.7 V , $R_L = 50\text{ k}\Omega$ ‡, $C_L = 100\text{ pF}$ ‡	25°C	0.35	0.55		0.35	0.55	$\text{V}/\mu\text{s}$	
		Full range	0.25			0.25			
V_n Equivalent input noise voltage	$f = 10\text{ Hz}$	25°C		43			43	$\text{nV}/\sqrt{\text{Hz}}$	
	$f = 1\text{ kHz}$	25°C		12			12		
$V_{N(PP)}$ Peak-to-peak equivalent input noise voltage	$f = 0.1\text{ Hz}$ to 1 Hz	25°C		0.6			0.6	μV	
	$f = 0.1\text{ Hz}$ to 10 Hz	25°C		1			1		
I_n Equivalent input noise current		25°C		0.6			0.6	$\text{fA}/\sqrt{\text{Hz}}$	
THD + N Total harmonic distortion plus noise	$V_O = 0.5\text{ V}$ to 2.5 V , $f = 20\text{ kHz}$, $R_L = 50\text{ k}\Omega$ ‡	$A_V = 1$		0.03%			0.03%		
		$A_V = 10$		0.05%			0.05%		
Gain-bandwidth product	$f = 1\text{ kHz}$, $C_L = 100\text{ pF}$ ‡	$R_L = 50\text{ k}\Omega$ ‡,	25°C		0.67		0.67	MHz	
BOM Maximum output-swing bandwidth	$V_{O(PP)} = 1\text{ V}$, $R_L = 50\text{ k}\Omega$ ‡,	$A_V = 1$, $C_L = 100\text{ pF}$ ‡	25°C		395		395	kHz	
t_s Settling time	$A_V = -1$, Step = 1 V to 2 V , $R_L = 50\text{ k}\Omega$ ‡, $C_L = 100\text{ pF}$ ‡	$T_o = 0.1\%$	25°C		5.6		5.6	μs	
		$T_o = 0.01\%$			12.5		12.5		
ϕ_m Phase margin at unity gain	$R_L = 50\text{ k}\Omega$ ‡,	$C_L = 100\text{ pF}$ ‡	25°C		55°		55°		
Gain margin			25°C		11		11		dB

† Full range is -40°C to 125°C for Q level part, -55°C to 125°C for M level part.

‡ Referenced to 1.5 V

TLV226x, TLV226xA
Advanced LinCMOS™ RAIL-TO-RAIL
OPERATIONAL AMPLIFIERS

SLOS186C – FEBRUARY 1997 – REVISED AUGUST 2006

TLV2262Q and TLV2262M electrical characteristics at specified free-air temperature, $V_{DD} = 5\text{ V}$ (unless otherwise noted)

PARAMETER	TEST CONDITIONS	T_A †	TLV2262Q, TLV2262M			TLV2262AQ, TLV2262AM			UNIT
			MIN	TYP	MAX	MIN	TYP	MAX	
V_{IO} Input offset voltage	$V_{DD} = \pm 2.5\text{ V}$, $V_{IC} = 0$, $V_O = 0$, $R_S = 50\ \Omega$	25°C	300	2500		300	950	μV	
		Full range		3000		1500			
α_{VIO} Temperature coefficient of input offset voltage		25°C to 125°C		2		2		$\mu\text{V}/^\circ\text{C}$	
Input offset voltage long-term drift (see Note 4)		25°C		0.003		0.003		$\mu\text{V}/\text{mo}$	
I_{IO} Input offset current		25°C		0.5	60		0.5	60	pA
		125°C			800			800	
I_{IB} Input bias current	25°C		1	60		1	60	pA	
	125°C			800			800		
V_{ICR} Common-mode input voltage range	$ V_{IO} \leq 5\text{ mV}$, $R_S = 50\ \Omega$	25°C	0 to 4	-0.3 to 4.2		0 to 4	-0.3 to 4.2	V	
		Full range	0 to 3.5			0 to 3.5			
V_{OH} High-level output voltage	$I_{OH} = -20\ \mu\text{A}$	25°C		4.99		4.99	V		
	$I_{OH} = -100\ \mu\text{A}$	25°C	4.85	4.94		4.85		4.94	
	$I_{OH} = -400\ \mu\text{A}$	Full range		4.82				4.82	
		25°C	4.7	4.85		4.7		4.85	
V_{OL} Low-level output voltage	$V_{IC} = 2.5\text{ V}$, $I_{OL} = 50\ \mu\text{A}$	25°C		0.01		0.01	V		
		25°C	0.09	0.15		0.09		0.15	
	Full range		0.15			0.15			
	$V_{IC} = 2.5\text{ V}$, $I_{OL} = 1\text{ mA}$	25°C	0.2	0.3		0.2		0.3	
Full range			0.3			0.3			
A_{VD} Large-signal differential voltage amplification	$V_{IC} = 2.5\text{ V}$, $V_O = 1\text{ V to }4\text{ V}$	$R_L = 50\text{ k}\Omega$ ‡	25°C	80	170		80	170	V/mV
			Full range		50			50	
		$R_L = 1\text{ M}\Omega$ ‡	25°C		550			550	
$r_{i(d)}$ Differential input resistance		25°C		10^{12}		10^{12}	Ω		
$r_{i(c)}$ Common-mode input resistance		25°C		10^{12}		10^{12}	Ω		
$C_{i(c)}$ Common-mode input capacitance	$f = 10\text{ kHz}$, P package	25°C		8		8	pF		
Z_o Closed-loop output impedance	$f = 100\text{ kHz}$, $A_V = 10$	25°C		240		240	Ω		
CMRR Common-mode rejection ratio	$V_{IC} = 0\text{ to }2.7\text{ V}$, $V_O = 2.5\text{ V}$, $R_S = 50\ \Omega$	25°C	70	83		70	83	dB	
		Full range		70			70		
k_{SVR} Supply voltage rejection ratio ($\Delta V_{DD}/\Delta V_{IO}$)	$V_{DD} = 4.4\text{ V to }8\text{ V}$, $V_{IC} = V_{DD}/2$, No load	25°C	80	95		80	95	dB	
		Full range		80			80		

† Full range is -40°C to 125°C for Q level part, -55°C to 125°C for M level part.

‡ Referenced to 2.5 V

NOTE 4: Typical values are based on the input offset voltage shift observed through 500 hours of operating life test at $T_A = 150^\circ\text{C}$ extrapolated to $T_A = 25^\circ\text{C}$ using the Arrhenius equation and assuming an activation energy of 0.96 eV.

TLV2262Q and TLV2262M electrical characteristics at specified free-air temperature, $V_{DD} = 5\text{ V}$ (unless otherwise noted) (continued)

PARAMETER	TEST CONDITIONS	T_A †	TLV2262Q, TLV2262M			TLV2262AQ, TLV2262AM			UNIT
			MIN	TYP	MAX	MIN	TYP	MAX	
I_{DD} Supply current	$V_O = 2.5\text{ V}$, No load	25°C	400	500		400	500	μA	
		Full range		500			500		

† Full range is -40°C to 125°C for Q level part, -55°C to 125°C for M level part.

TLV2262Q and TLV2262M operating characteristics at specified free-air temperature, $V_{DD} = 5\text{ V}$

PARAMETER	TEST CONDITIONS	T_A †	TLV2262Q, TLV2262M			TLV2262AQ, TLV2262AM			UNIT
			MIN	TYP	MAX	MIN	TYP	MAX	
SR Slew rate at unity gain	$V_O = 0.5\text{ V to }3.5\text{ V}$, $C_L = 100\text{ pF}^\ddagger$, $R_L = 50\text{ k}\Omega^\ddagger$	25°C	0.35	0.55		0.35	0.55	$\text{V}/\mu\text{s}$	
		Full range	0.25			0.25			
V_n Equivalent input noise voltage	$f = 10\text{ Hz}$ $f = 1\text{ kHz}$	25°C		40			40	$\text{nV}/\sqrt{\text{Hz}}$	
		25°C		12			12		
$V_{N(PP)}$ Peak-to-peak equivalent input noise voltage	$f = 0.1\text{ Hz to }1\text{ Hz}$ $f = 0.1\text{ Hz to }10\text{ Hz}$	25°C		0.7			0.7	μV	
		25°C		1.3			1.3		
I_n Equivalent input noise current		25°C		0.6			0.6	$\text{fA}/\sqrt{\text{Hz}}$	
THD + N Total harmonic distortion plus noise	$V_O = 0.5\text{ V to }2.5\text{ V}$, $f = 20\text{ kHz}$, $R_L = 50\text{ k}\Omega^\ddagger$	25°C		$A_V = 1$		0.017%		0.017%	
				$A_V = 10$		0.03%		0.03%	
Gain-bandwidth product	$f = 50\text{ kHz}$, $C_L = 100\text{ pF}^\ddagger$, $R_L = 50\text{ k}\Omega^\ddagger$	25°C		0.71			0.71	MHz	
B_{OM} Maximum output-swing bandwidth	$V_{O(PP)} = 2\text{ V}$, $R_L = 50\text{ k}\Omega^\ddagger$, $A_V = 1$, $C_L = 100\text{ pF}^\ddagger$	25°C		185			185	kHz	
t_s Settling time	$A_V = -1$, Step = $0.5\text{ V to }2.5\text{ V}$, $R_L = 50\text{ k}\Omega^\ddagger$, $C_L = 100\text{ pF}^\ddagger$	25°C		To 0.1%		6.4		6.4	μs
				To 0.01%		14.1		14.1	
ϕ_m Phase margin at unity gain	$R_L = 50\text{ k}\Omega^\ddagger$, $C_L = 100\text{ pF}^\ddagger$	25°C		56°			56°		
		25°C		11			11		
Gain margin		25°C		11			11	dB	

† Full range is -40°C to 125°C for Q level part, -55°C to 125°C for M level part.

‡ Referenced to 2.5 V

TLV226x, TLV226xA Advanced LinCMOS™ RAIL-TO-RAIL OPERATIONAL AMPLIFIERS

SLOS186C – FEBRUARY 1997 – REVISED AUGUST 2006

TLV2264Q and TLV2264M electrical characteristics at specified free-air temperature, $V_{DD} = 3\text{ V}$ (unless otherwise noted)

PARAMETER	TEST CONDITIONS	T_A †	TLV2264Q, TLV2264M			TLV2264AQ, TLV2264AM			UNIT
			MIN	TYP	MAX	MIN	TYP	MAX	
V_{IO} Input offset voltage		25°C	300	2500		300	950	μV	
		Full range			3000		1500		
α_{VIO} Temperature coefficient of input offset voltage		25°C to 125°C	2			2			$\mu\text{V}/^\circ\text{C}$
Input offset voltage long-term drift (see Note 4)	$V_{DD} = \pm 1.5\text{ V}$, $V_{IC} = 0$, $V_O = 0$, $R_S = 50\ \Omega$	25°C	0.003			0.003			$\mu\text{V}/\text{mo}$
I_{IO} Input offset current		25°C	0.5	60		0.5	60	pA	
		125°C		800		800			
I_{IB} Input bias current		25°C	1	60		1	60	pA	
		125°C		800		800			
V_{ICR} Common-mode input voltage range	$R_S = 50\ \Omega$, $ V_{IO} \leq 5\text{ mV}$	25°C	0 to 2	-0.3 to 2.2		0 to 2	-0.3 to 2.2	V	
		Full range	0 to 1.7		0 to 1.7				
V_{OH} High-level output voltage	$I_{OH} = -20\ \mu\text{A}$	25°C	2.99			2.99			V
	$I_{OH} = -100\ \mu\text{A}$	25°C	2.85			2.85			
	$I_{OH} = -400\ \mu\text{A}$	Full range	2.82			2.82			
		25°C	2.7			2.7			
V_{OL} Low-level output voltage	$V_{IC} = 1.5\text{ V}$, $I_{OL} = 50\ \mu\text{A}$	25°C	10			10			mV
	$V_{IC} = 1.5\text{ V}$, $I_{OL} = 500\ \mu\text{A}$	25°C	100	150		100	150		
		Full range	150			150			
	$V_{IC} = 1.5\text{ V}$, $I_{OL} = 1\text{ mA}$	25°C	200	300		200	300		
Full range		300			300				
AVD Large-signal differential voltage amplification	$V_{IC} = 1.5\text{ V}$, $V_O = 1\text{ V to }2\text{ V}$	$R_L = 50\ \text{k}\Omega$ ‡	25°C	60	100		60	100	V/mV
			Full range	25			25		
		$R_L = 1\ \text{M}\Omega$ ‡	25°C	100			100		
$r_{i(d)}$ Differential input resistance		25°C	10^{12}			10^{12}			Ω
$r_{i(c)}$ Common-mode input resistance		25°C	10^{12}			10^{12}			Ω
$c_{i(c)}$ Common-mode input capacitance	$f = 10\text{ kHz}$, N package	25°C	8			8			pF
z_o Closed-loop output impedance	$f = 100\text{ kHz}$, $A_V = 10$	25°C	270			270			Ω
CMRR Common-mode rejection ratio	$V_{IC} = 0\text{ to }1.7\text{ V}$, $V_O = 1.5\text{ V}$, $R_S = 50\ \Omega$	25°C	65	75		65	77	dB	
		Full range	60			60			
k_{SVR} Supply voltage rejection ratio ($\Delta V_{DD}/\Delta V_{IO}$)	$V_{DD} = 2.7\text{ V to }8\text{ V}$, $V_{IC} = V_{DD}/2$, No load	25°C	80	95		80	100	dB	
		Full range	80			80			

† Full range is -40°C to 125°C for Q level part, -55°C to 125°C for M level part.

‡ Referenced to 1.5 V

NOTE 4: Typical values are based on the input offset voltage shift observed through 500 hours of operating life test at $T_A = 150^\circ\text{C}$ extrapolated to $T_A = 25^\circ\text{C}$ using the Arrhenius equation and assuming an activation energy of 0.96 eV.

TLV2264Q and TLV2264M electrical characteristics at specified free-air temperature, $V_{DD} = 3\text{ V}$ (unless otherwise noted) (continued)

PARAMETER	TEST CONDITIONS	T_A †	TLV2264Q, TLV2264M			TLV2264AQ, TLV2264AM			UNIT
			MIN	TYP	MAX	MIN	TYP	MAX	
I_{DD}	Supply current (four amplifiers) $V_O = 1.5\text{ V}$, No load	25°C	0.8		1	0.8		1	mA
		Full range			1			1	

† Full range is -40°C to 125°C for Q level part, -55°C to 125°C for M level part.

TLV2264Q and TLV2264M operating characteristics at specified free-air temperature, $V_{DD} = 3\text{ V}$

PARAMETER	TEST CONDITIONS	T_A †	TLV2264Q, TLV2264M			TLV2264AQ, TLV2264AM			UNIT
			MIN	TYP	MAX	MIN	TYP	MAX	
SR	Slew rate at unity gain $V_O = 0.5\text{ V}$ to 1.7 V , $R_L = 50\text{ k}\Omega$ ‡, $C_L = 100\text{ pF}$ ‡	25°C	0.35	0.55		0.35	0.55		$\text{V}/\mu\text{s}$
		Full range	0.25			0.25			
V_n	Equivalent input noise voltage	$f = 10\text{ Hz}$	25°C			43			$\text{nV}/\sqrt{\text{Hz}}$
		$f = 1\text{ kHz}$	25°C			12			
$V_{N(PP)}$	Peak-to-peak equivalent input noise voltage	$f = 0.1\text{ Hz}$ to 1 Hz	25°C			0.6			μV
		$f = 0.1\text{ Hz}$ to 10 Hz	25°C			1			
I_n	Equivalent input noise current	25°C	0.6			0.6			$\text{fA}/\sqrt{\text{Hz}}$
THD + N	Total harmonic distortion plus noise $V_O = 0.5\text{ V}$ to 2.5 V , $f = 20\text{ kHz}$, $R_L = 50\text{ k}\Omega$ ‡	$A_V = 1$	25°C			0.03%			
		$A_V = 10$	25°C			0.05%			
	Gain-bandwidth product $f = 1\text{ kHz}$, $C_L = 100\text{ pF}$ ‡	$R_L = 50\text{ k}\Omega$ ‡,	25°C			0.67			MHz
B_{OM}	Maximum output-swing bandwidth $V_{O(PP)} = 1\text{ V}$, $R_L = 50\text{ k}\Omega$ ‡,	$A_V = 1$, $C_L = 100\text{ pF}$ ‡	25°C			395			kHz
t_s	Settling time $A_V = -1$, Step = 1 V to 2 V , $R_L = 50\text{ k}\Omega$ ‡, $C_L = 100\text{ pF}$ ‡	$T_o = 0.1\%$	25°C			5.6			μs
		$T_o = 0.01\%$	25°C			12.5			
ϕ_m	Phase margin at unity gain $R_L = 50\text{ k}\Omega$ ‡,	$C_L = 100\text{ pF}$ ‡	25°C			55°			
			25°C			11			
	Gain margin		25°C			11			dB

† Full range is -40°C to 125°C for Q level part, -55°C to 125°C for M level part.

‡ Referenced to 1.5 V

TLV226x, TLV226xA
Advanced LinCMOS™ RAIL-TO-RAIL
OPERATIONAL AMPLIFIERS

SLOS186C – FEBRUARY 1997 – REVISED AUGUST 2006

TLV2264Q and TLV2264M electrical characteristics at specified free-air temperature, $V_{DD} = 5\text{ V}$ (unless otherwise noted)

PARAMETER	TEST CONDITIONS	T_A †	TLV2264Q, TLV2264M			TLV2264AQ, TLV2264AM			UNIT
			MIN	TYP	MAX	MIN	TYP	MAX	
V_{IO} Input offset voltage		25°C	300	2500		300	950	μV	
		Full range		3000		1500			
α_{VIO} Temperature coefficient of input offset voltage	$V_{DD} \pm = \pm 2.5\text{ V}$, $V_{IC} = 0$, $V_O = 0$, $R_S = 50\ \Omega$	25°C to 125°C	2			2			$\mu\text{V}/^\circ\text{C}$
Input offset voltage long-term drift (see Note 4)		25°C	0.003			0.003			$\mu\text{V}/\text{mo}$
I_{IO} Input offset current		25°C	0.5	60		0.5	60	pA	
		125°C	800			800			
I_{IB} Input bias current	25°C	1	60		1	60	pA		
	125°C	800			800				
V_{ICR} Common-mode input voltage range	$ V_{IO} \leq 5\text{ mV}$, $R_S = 50\ \Omega$	25°C	0 to 4	-0.3 to 4.2		0 to 4	-0.3 to 4.2	V	
		Full range	0 to 3.5		0 to 3.5				
V_{OH} High-level output voltage	$I_{OH} = -20\ \mu\text{A}$	25°C	4.99			4.99			V
	$I_{OH} = -100\ \mu\text{A}$	25°C	4.85	4.94		4.85	4.94		
	$I_{OH} = -400\ \mu\text{A}$	Full range	4.82			4.82			
		25°C	4.7	4.85		4.7	4.85		
V_{OL} Low-level output voltage	$V_{IC} = 2.5\text{ V}$, $I_{OL} = 50\ \mu\text{A}$	25°C	0.01			0.01			V
		25°C	0.09	0.15		0.09	0.15		
	$V_{IC} = 2.5\text{ V}$, $I_{OL} = 500\ \mu\text{A}$	Full range	0.15			0.15			
		25°C	0.2	0.3		0.2	0.3		
$V_{IC} = 2.5\text{ V}$, $I_{OL} = 1\text{ mA}$	Full range	0.3			0.3				
		25°C	0.3			0.3			
	$V_{IC} = 2.5\text{ V}$, $V_O = 1\text{ V to }4\text{ V}$	$R_L = 50\text{ k}\Omega$ ‡	25°C	80	170		80	170	V/mV
Full range			50			50			
$R_L = 1\text{ M}\Omega$ ‡		25°C	550			550			
$r_{i(d)}$ Differential input resistance		25°C	10^{12}			10^{12}			Ω
$r_{i(c)}$ Common-mode input resistance		25°C	10^{12}			10^{12}			Ω
$C_{i(c)}$ Common-mode input capacitance	$f = 10\text{ kHz}$, N package	25°C	8			8			pF
z_o Closed-loop output impedance	$f = 100\text{ kHz}$, $A_V = 10$	25°C	240			240			Ω
CMRR Common-mode rejection ratio	$V_{IC} = 0\text{ to }2.7\text{ V}$, $V_O = 2.5\text{ V}$, $R_S = 50\ \Omega$	25°C	70	83		70	83	dB	
		Full range	70			70			
k_{SVR} Supply voltage rejection ratio ($\Delta V_{DD}/\Delta V_{IO}$)	$V_{DD} = 4.4\text{ V to }8\text{ V}$, $V_{IC} = V_{DD}/2$, No load	25°C	80	95		80	95	dB	
		Full range	80			80			

† Full range is -40°C to 125°C for Q level part, -55°C to 125°C for M level part.

‡ Referenced to 2.5 V

NOTE 4: Typical values are based on the input offset voltage shift observed through 500 hours of operating life test at $T_A = 150^\circ\text{C}$ extrapolated to $T_A = 25^\circ\text{C}$ using the Arrhenius equation and assuming an activation energy of 0.96 eV.

TLV226x, TLV226xA
Advanced LinCMOS™ RAIL-TO-RAIL
OPERATIONAL AMPLIFIERS

SLOS186C – FEBRUARY 1997 – REVISED AUGUST 2006

TLV2264Q and TLV2264M electrical characteristics at specified free-air temperature, $V_{DD} = 5\text{ V}$ (unless otherwise noted) (continued)

PARAMETER	TEST CONDITIONS	T_A †	TLV2264Q, TLV2264M			TLV2264AQ, TLV2264AM			UNIT
			MIN	TYP	MAX	MIN	TYP	MAX	
I_{DD}	Supply current (four amplifiers)	$V_O = 2.5\text{ V}$, No load	25°C	0.8	1	0.8	1	mA	
			Full range		1		1		

† Full range is -40°C to 125°C for Q level part, -55°C to 125°C for M level part.

TLV2264Q and TLV2264M operating characteristics at specified free-air temperature, $V_{DD} = 5\text{ V}$

PARAMETER	TEST CONDITIONS	T_A †	TLV2264Q, TLV2264M			TLV2264AQ, TLV2264AM			UNIT	
			MIN	TYP	MAX	MIN	TYP	MAX		
SR	Slew rate at unity gain	$V_O = 0.5\text{ V}$ to 3.5 V , $R_L = 50\text{ k}\Omega$ ‡, $C_L = 100\text{ pF}$ ‡	25°C	0.35	0.55	0.35	0.55	V/ μs		
			Full range	0.25		0.25				
V_n	Equivalent input noise voltage	$f = 10\text{ Hz}$	25°C	40			40			nV/ $\sqrt{\text{Hz}}$
			$f = 1\text{ kHz}$	12			12			
$V_{N(PP)}$	Peak-to-peak equivalent input noise voltage	$f = 0.1\text{ Hz}$ to 1 Hz	25°C	0.7			0.7			μV
			$f = 0.1\text{ Hz}$ to 10 Hz	1.3			1.3			
I_n	Equivalent input noise current		25°C	0.6			0.6			fA/ $\sqrt{\text{Hz}}$
THD + N	Total harmonic distortion plus noise	$V_O = 0.5\text{ V}$ to 2.5 V , $f = 20\text{ kHz}$, $R_L = 50\text{ k}\Omega$ ‡	25°C	$A_V = 1$		0.017%		0.017%		
				$A_V = 10$		0.03%		0.03%		
	Gain-bandwidth product	$f = 50\text{ kHz}$, $C_L = 100\text{ pF}$ ‡	25°C	0.71			0.71			MHz
BOM	Maximum output-swing bandwidth	$V_{O(PP)} = 2\text{ V}$, $R_L = 50\text{ k}\Omega$ ‡	25°C	185			185			kHz
t_s	Settling time	$A_V = -1$, Step = 0.5 V to 2.5 V , $R_L = 50\text{ k}\Omega$ ‡, $C_L = 100\text{ pF}$ ‡	25°C	$T_o = 0.1\%$		6.4		6.4		μs
				$T_o = 0.01\%$		14.1		14.1		
ϕ_m	Phase margin at unity gain	$R_L = 50\text{ k}\Omega$ ‡, $C_L = 100\text{ pF}$ ‡	25°C	56°			56°			
	Gain margin		25°C	11			11			

† Full range is -40°C to 125°C for Q level part, -55°C to 125°C for M level part.

‡ Referenced to 2.5 V

TLV226x, TLV226xA
Advanced LinCMOS™ RAIL-TO-RAIL
OPERATIONAL AMPLIFIERS

SLOS186C – FEBRUARY 1997 – REVISED AUGUST 2006

TYPICAL CHARACTERISTICS

Table of Graphs

		FIGURE
V_{IO}	Input offset voltage	Distribution vs Common-mode voltage 2 – 5 6, 7
αV_{IO}	Input offset voltage temperature coefficient	Distribution 8 – 11
I_{IB}/I_{IO}	Input bias and input offset currents	vs Free-air temperature 12
V_I	Input voltage	vs Supply voltage vs Free-air temperature 13 14
V_{OH}	High-level output voltage	vs High-level output current 15, 18
V_{OL}	Low-level output voltage	vs Low-level output current 16, 17, 19
$V_{O(PP)}$	Maximum peak-to-peak output voltage	vs Frequency 20
I_{OS}	Short-circuit output current	vs Supply voltage vs Free-air temperature 21 22
V_{ID}	Differential input voltage	vs Output voltage 23, 24
A_{VD}	Differential voltage amplification	vs Load resistance 25
A_{VD}	Large-signal differential voltage amplification	vs Frequency vs Free-air temperature 26, 27 28, 29
z_o	Output impedance	vs Frequency 30, 31
$CMRR$	Common-mode rejection ratio	vs Frequency vs Free-air temperature 32 33
k_{SVR}	Supply-voltage rejection ratio	vs Frequency vs Free-air temperature 34, 35 36, 37
I_{DD}	Supply current	vs Free-air temperature 38, 39
SR	Slew rate	vs Load capacitance vs Free-air temperature 40 41
V_O	Inverting large-signal pulse response	42, 43
V_O	Voltage-follower large-signal pulse response	44, 45
V_O	Inverting small-signal pulse response	46, 47
V_O	Voltage-follower small-signal pulse response	48, 49
V_n	Equivalent input noise voltage	vs Frequency 50, 51
	Input noise voltage	Over a 10-second period 52
	Integrated noise voltage	vs Frequency 53
$THD + N$	Total harmonic distortion plus noise	vs Frequency 54
	Gain-bandwidth product	vs Supply voltage vs Free-air temperature 55 56
ϕ_m	Phase margin	vs Frequency vs Load capacitance 26, 27 57
	Gain margin	vs Load capacitance 58
B_1	Unity-gain bandwidth	vs Load capacitance 59
	Overestimation of phase margin	vs Load capacitance 60

TYPICAL CHARACTERISTICS

DISTRIBUTION OF TLV2262
 INPUT OFFSET VOLTAGE

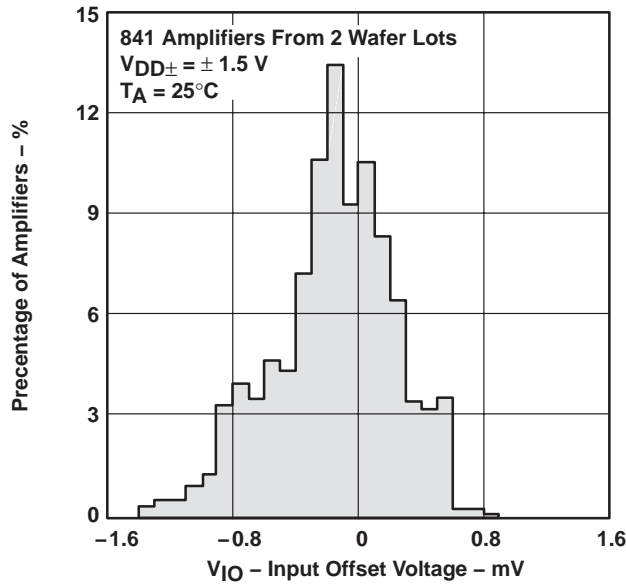

Figure 2

DISTRIBUTION OF TLV2262
 INPUT OFFSET VOLTAGE

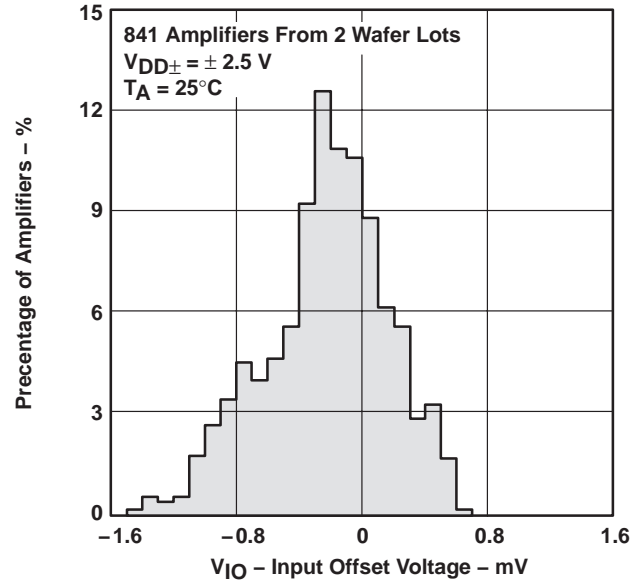

Figure 3

DISTRIBUTION OF TLV2264
 INPUT OFFSET VOLTAGE

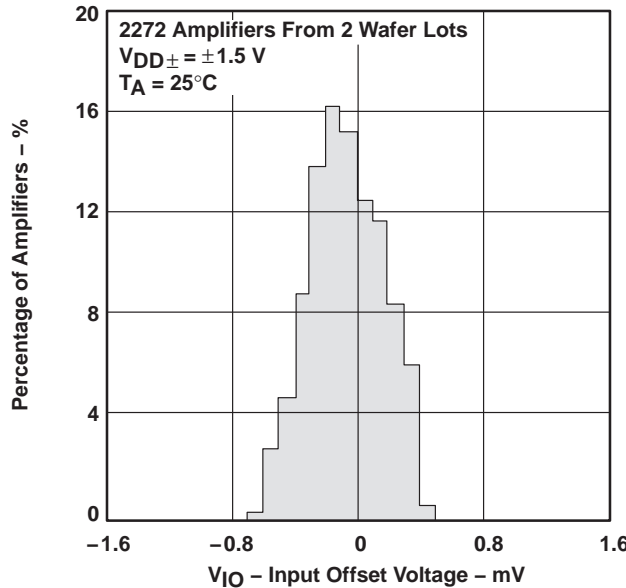

Figure 4

DISTRIBUTION OF TLV2264
 INPUT OFFSET VOLTAGE

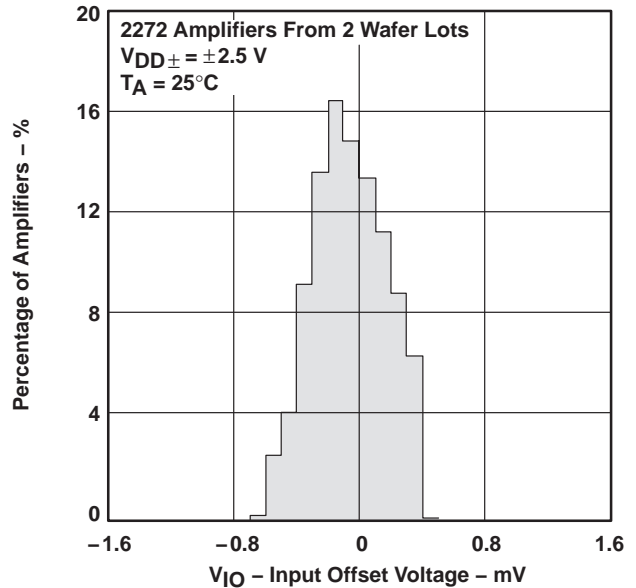

Figure 5

TYPICAL CHARACTERISTICS

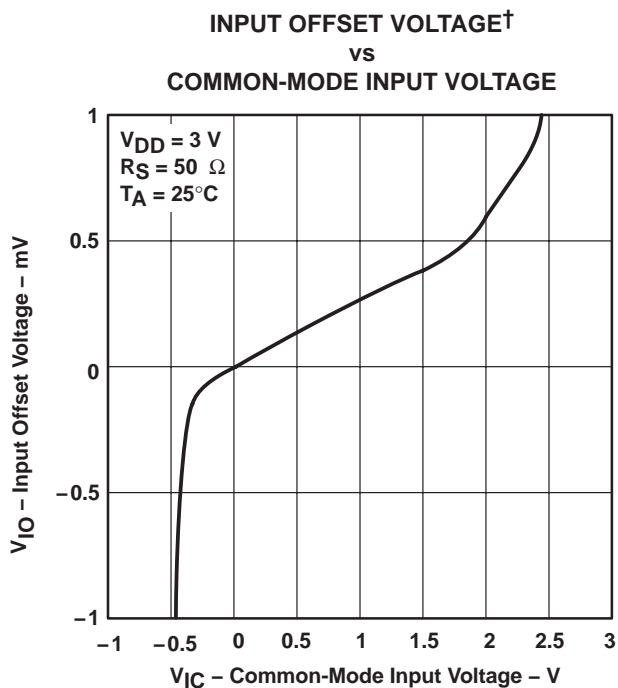

Figure 6

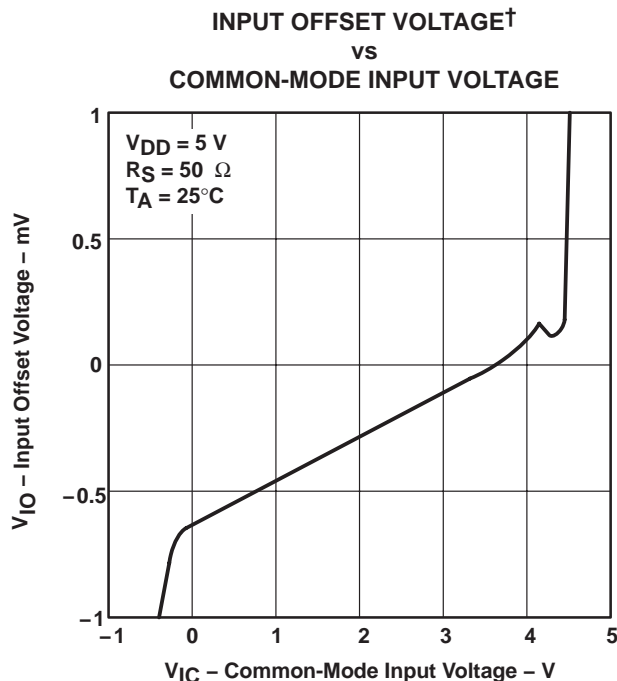

Figure 7

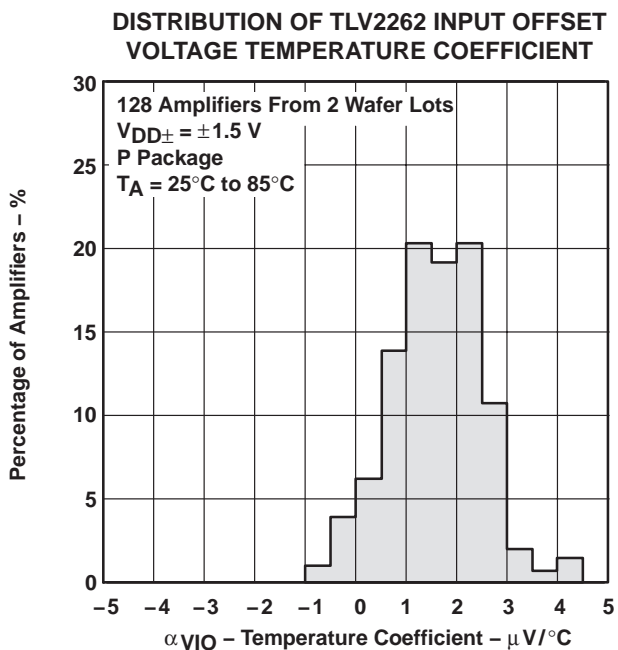

Figure 8

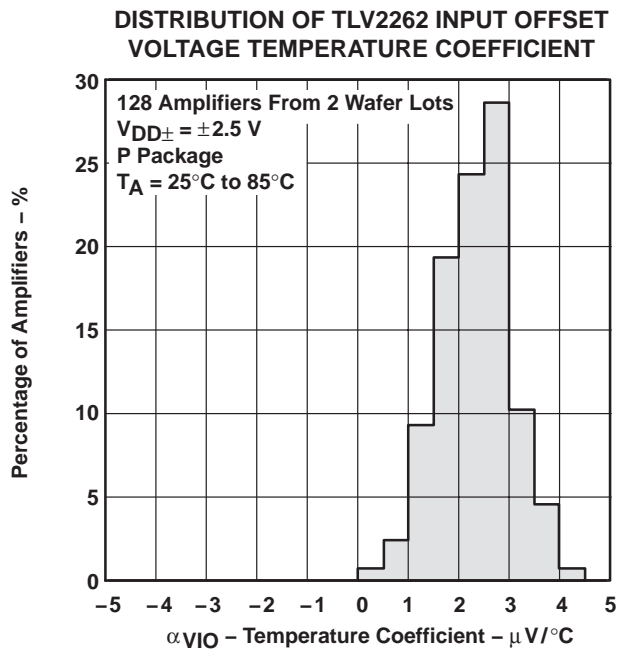

Figure 9

† For all curves where $V_{DD} = 5\text{ V}$, all loads are referenced to 2.5 V. For all curves where $V_{DD} = 3\text{ V}$, all loads are referenced to 1.5 V.

TYPICAL CHARACTERISTICS

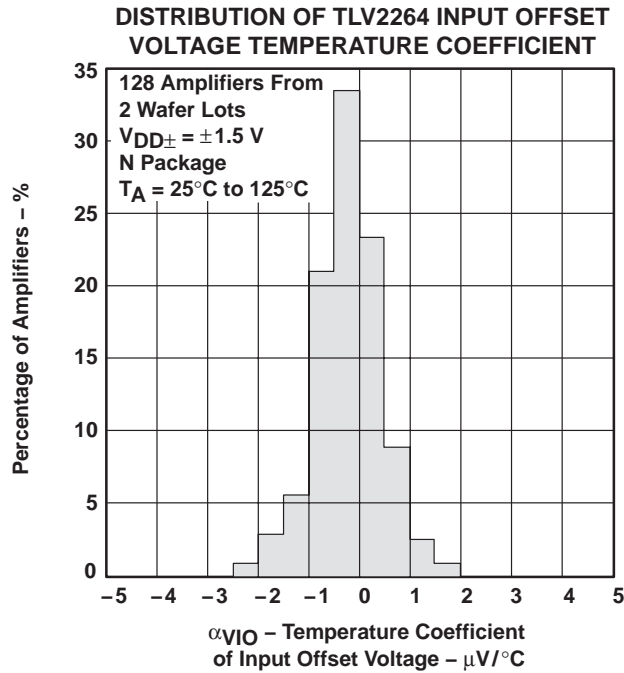

Figure 10

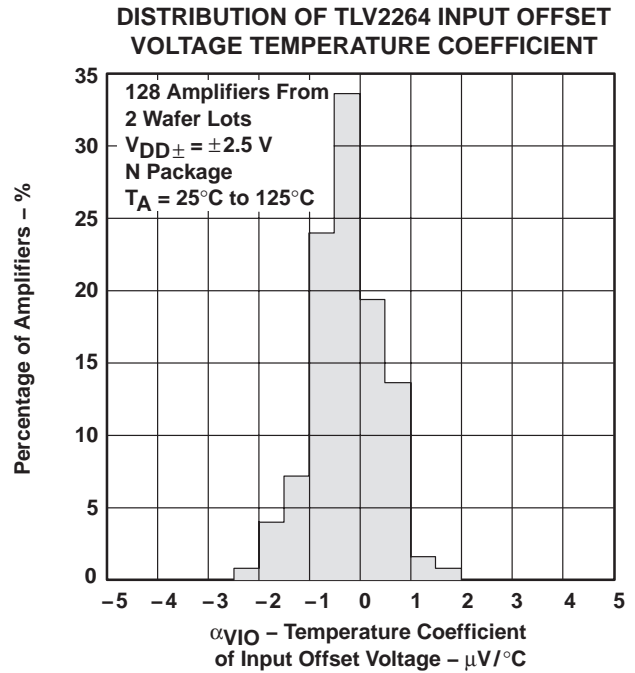

Figure 11

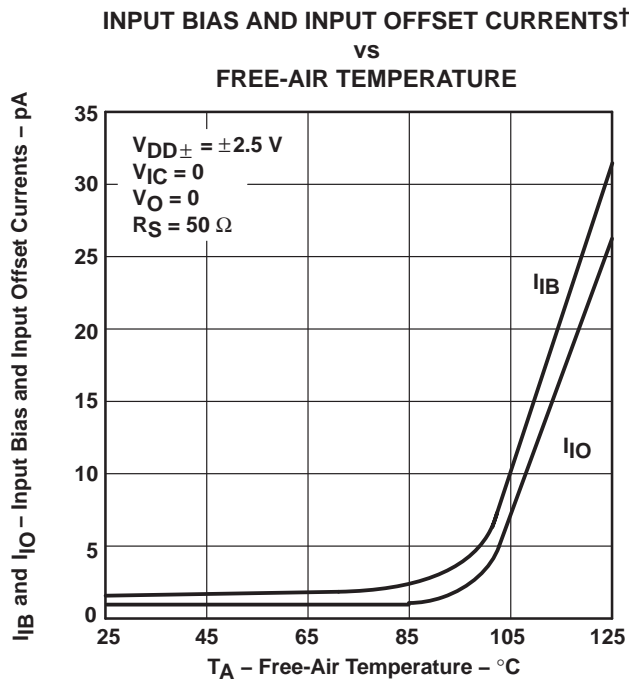

Figure 12

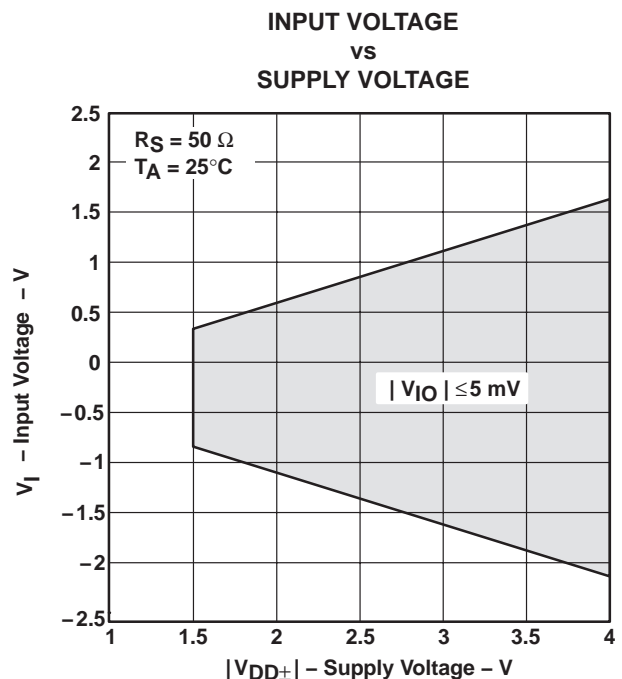

Figure 13

† Data at high and low temperatures are applicable only within the rated operating free-air temperature ranges of the various devices.

TYPICAL CHARACTERISTICS

INPUT VOLTAGE†‡
vs
FREE-AIR TEMPERATURE

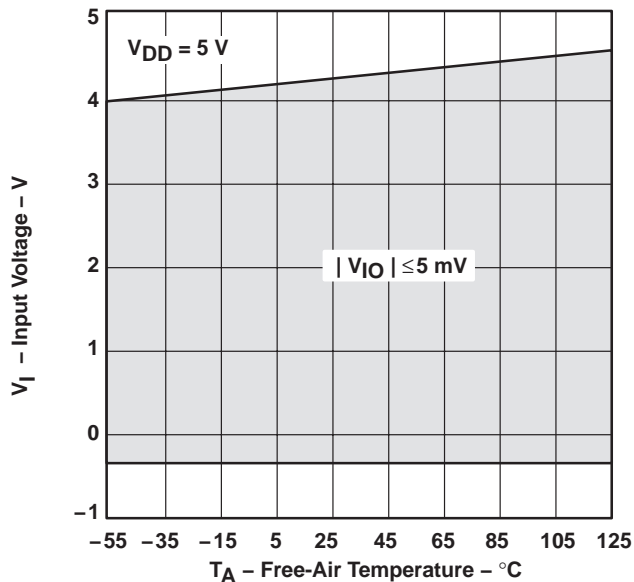

Figure 14

HIGH-LEVEL OUTPUT VOLTAGE†‡
vs
HIGH-LEVEL OUTPUT CURRENT

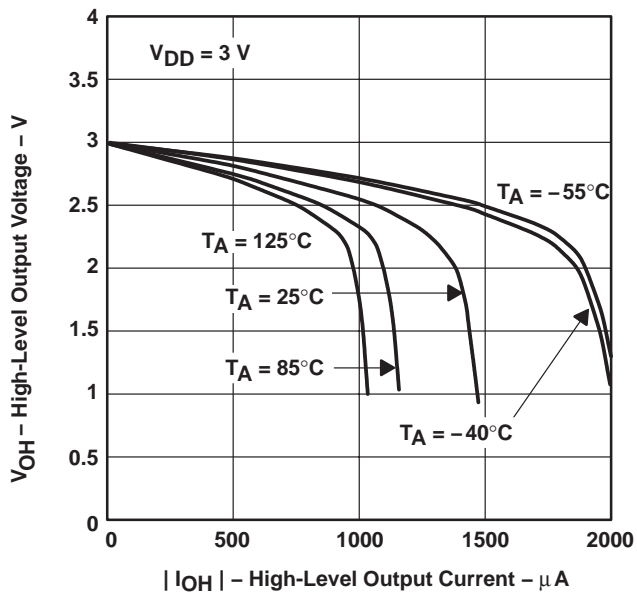

Figure 15

LOW-LEVEL OUTPUT VOLTAGE†
vs
LOW-LEVEL OUTPUT CURRENT

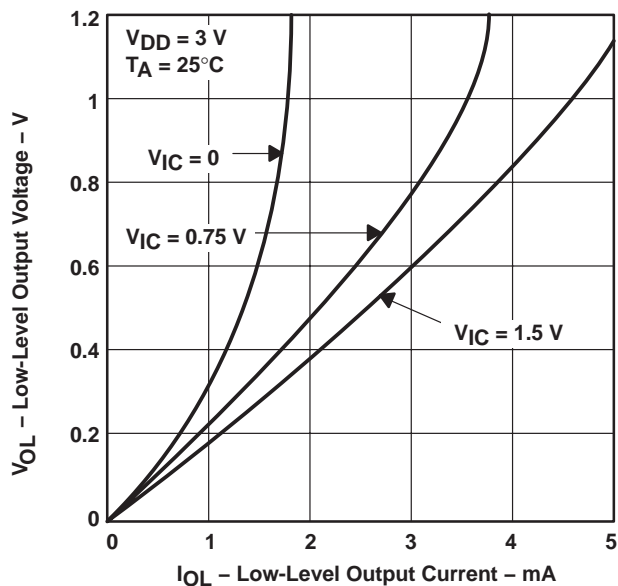

Figure 16

LOW-LEVEL OUTPUT VOLTAGE†‡
vs
LOW-LEVEL OUTPUT CURRENT

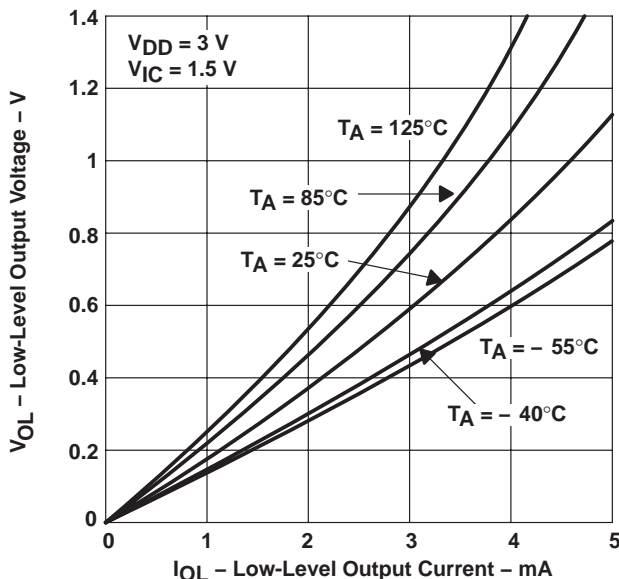

Figure 17

† Data at high and low temperatures are applicable only within the rated operating free-air temperature ranges of the various devices.

‡ For all curves where V_{DD} = 5 V, all loads are referenced to 2.5 V. For all curves where V_{DD} = 3 V, all loads are referenced to 1.5 V.

TYPICAL CHARACTERISTICS

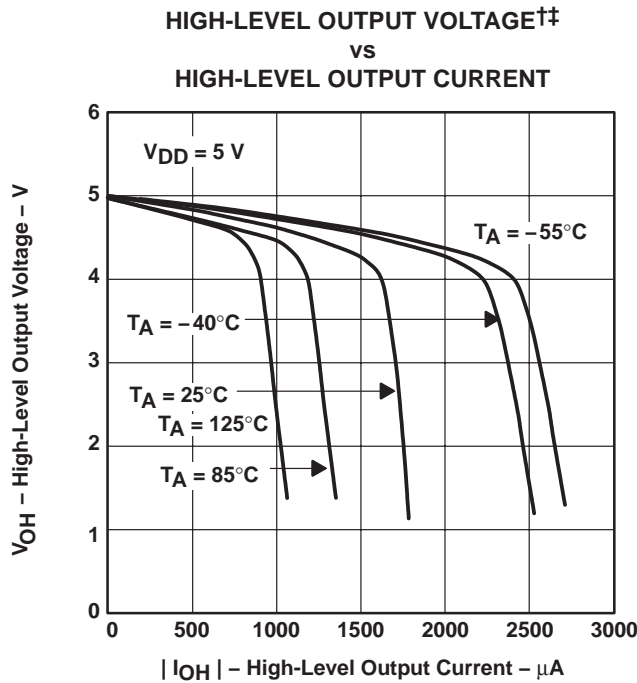

Figure 18

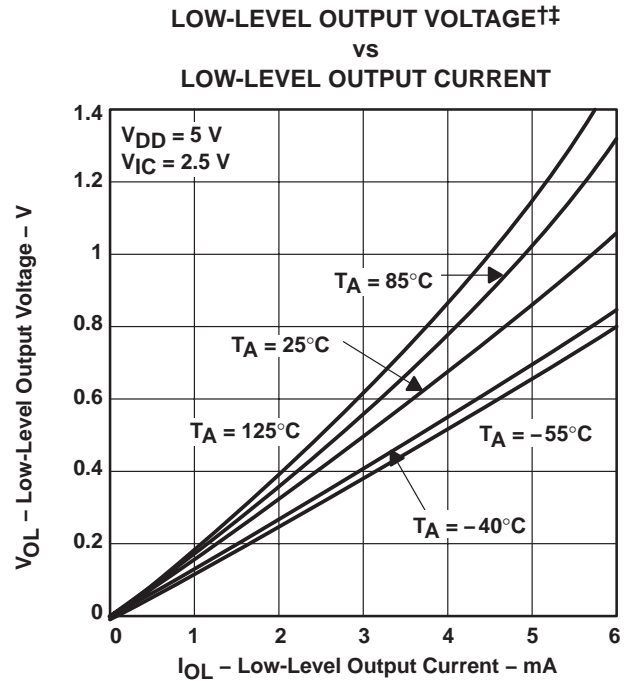

Figure 19

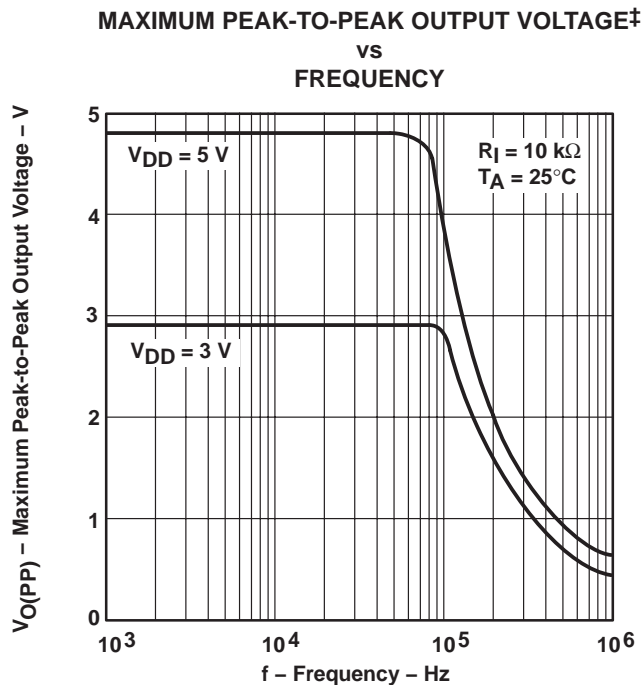

Figure 20

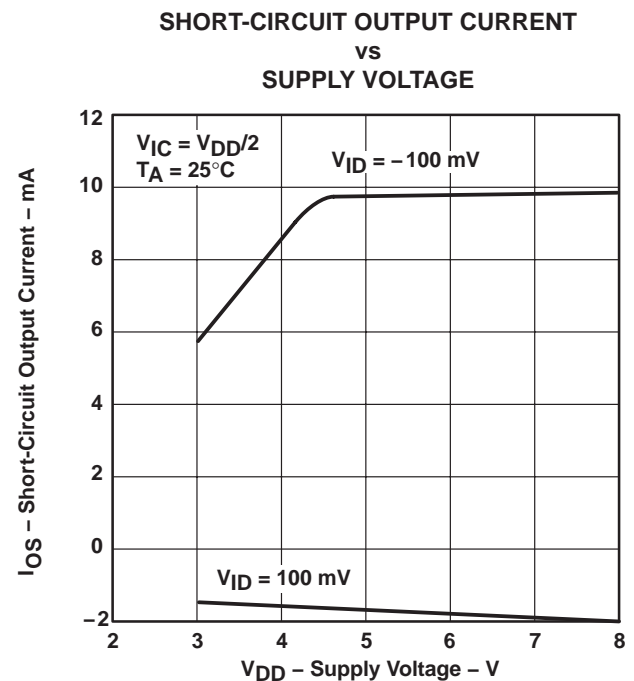

Figure 21

† Data at high and low temperatures are applicable only within the rated operating free-air temperature ranges of the various devices.
 ‡ For all curves where $V_{DD} = 5 V$, all loads are referenced to 2.5 V. For all curves where $V_{DD} = 3 V$, all loads are referenced to 1.5 V.

TYPICAL CHARACTERISTICS

SHORT-CIRCUIT OUTPUT CURRENT†
vs
FREE-AIR TEMPERATURE

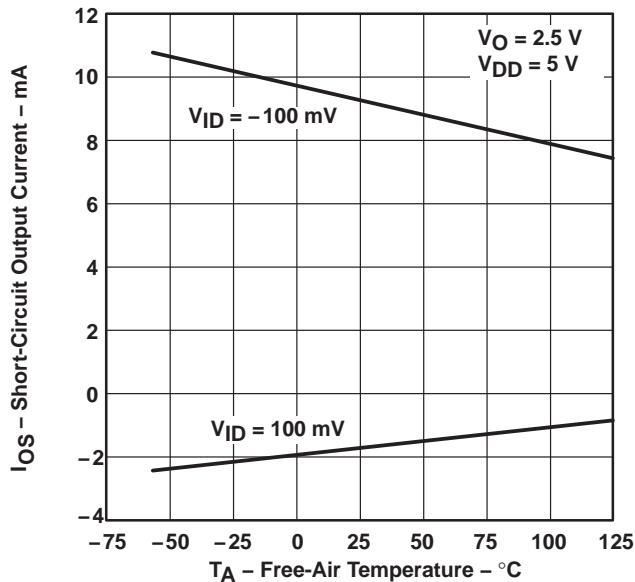

Figure 22

DIFFERENTIAL INPUT VOLTAGE‡
vs
OUTPUT VOLTAGE

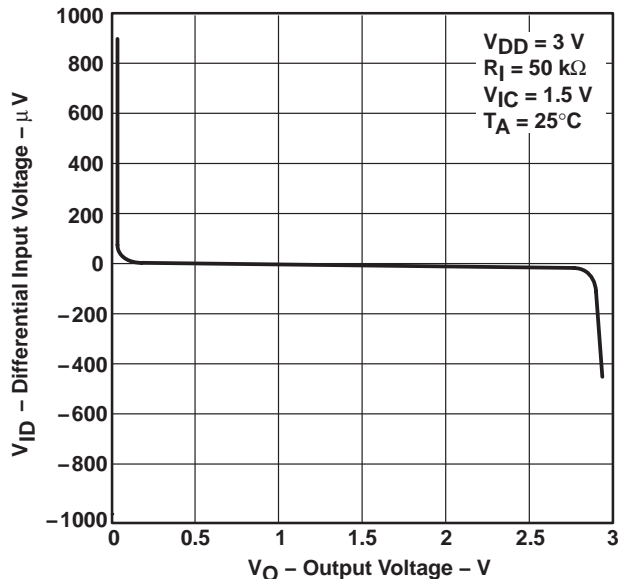

Figure 23

DIFFERENTIAL INPUT VOLTAGE‡
vs
OUTPUT VOLTAGE

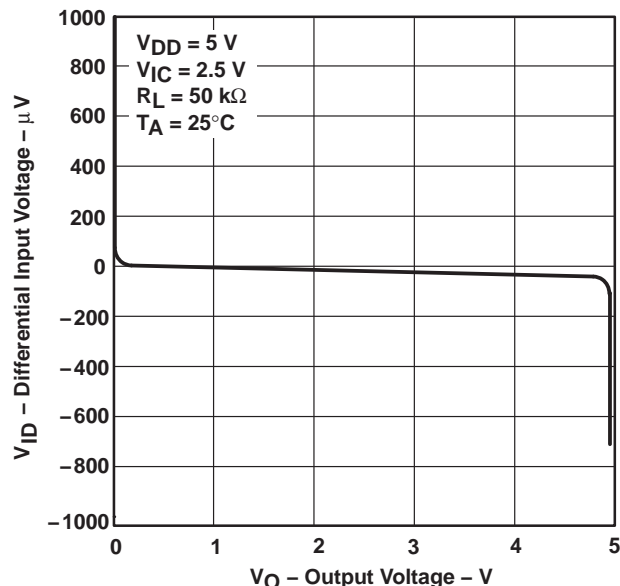

Figure 24

DIFFERENTIAL VOLTAGE AMPLIFICATION‡
vs
LOAD RESISTANCE

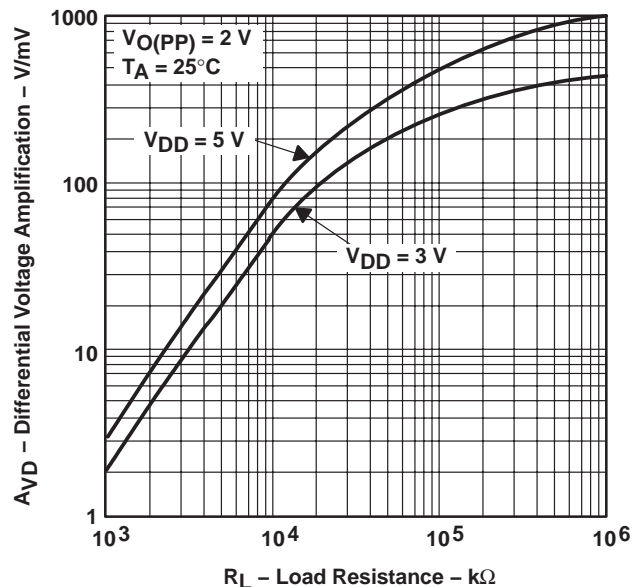

Figure 25

† Data at high and low temperatures are applicable only within the rated operating free-air temperature ranges of the various devices.

‡ For all curves where $V_{DD} = 5\text{ V}$, all loads are referenced to 2.5 V. For all curves where $V_{DD} = 3\text{ V}$, all loads are referenced to 1.5 V.

TYPICAL CHARACTERISTICS

LARGE-SIGNAL DIFFERENTIAL VOLTAGE
 AMPLIFICATION AND PHASE MARGIN†
 vs
 FREQUENCY

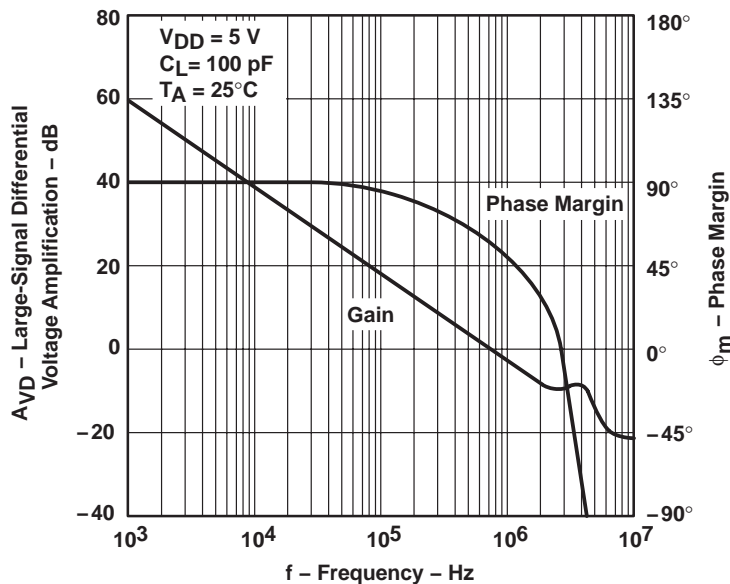

Figure 26

LARGE-SIGNAL DIFFERENTIAL VOLTAGE
 AMPLIFICATION AND PHASE MARGIN†
 vs
 FREQUENCY

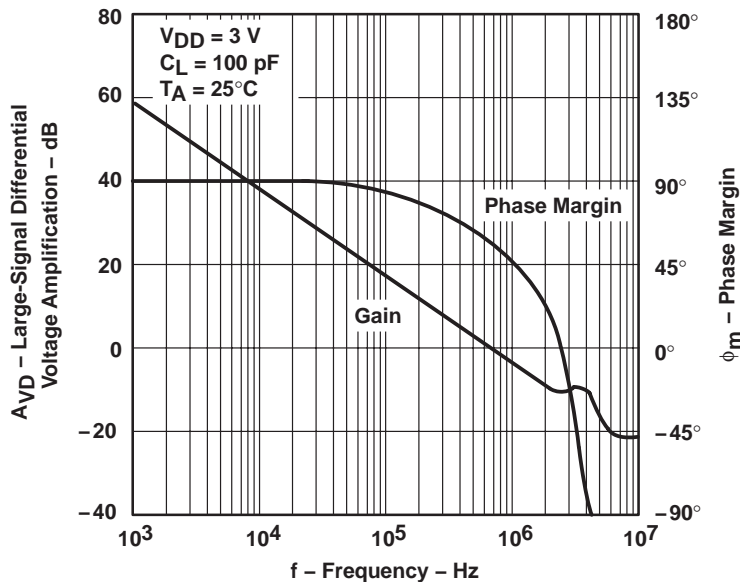

Figure 27

† For all curves where $V_{DD} = 5\text{ V}$, all loads are referenced to 2.5 V. For all curves where $V_{DD} = 3\text{ V}$, all loads are referenced to 1.5 V.

TYPICAL CHARACTERISTICS

LARGE-SIGNAL DIFFERENTIAL VOLTAGE AMPLIFICATION†‡
vs
FREE-AIR TEMPERATURE

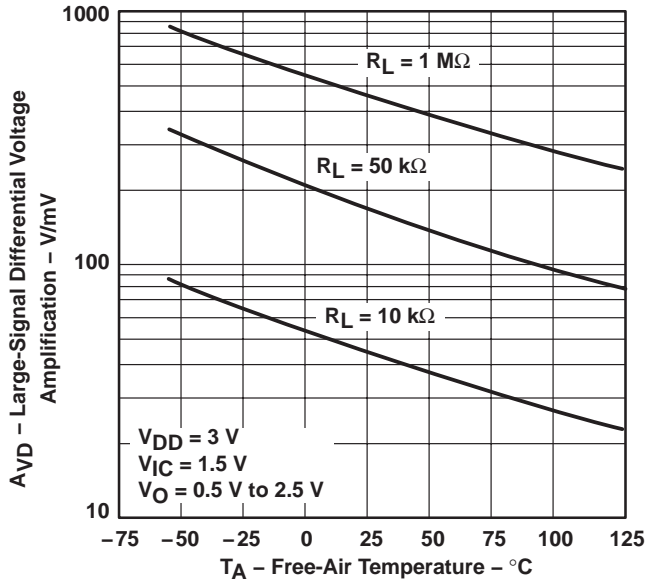

Figure 28

LARGE-SIGNAL DIFFERENTIAL VOLTAGE AMPLIFICATION†‡
vs
FREE-AIR TEMPERATURE

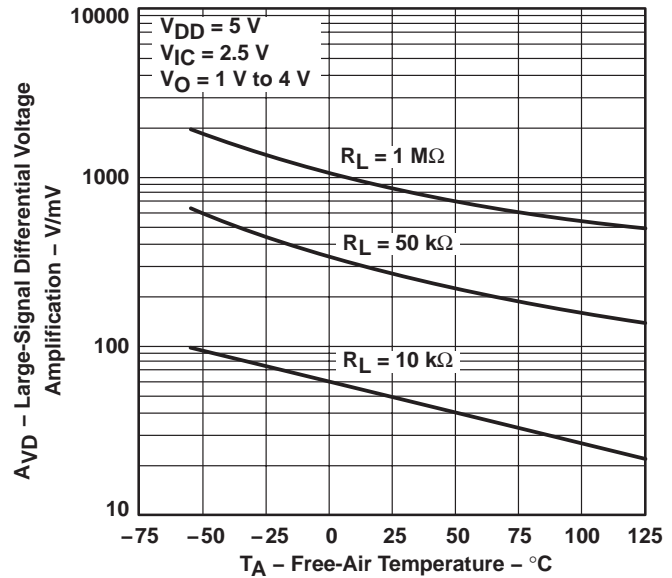

Figure 29

OUTPUT IMPEDANCE‡
vs
FREQUENCY

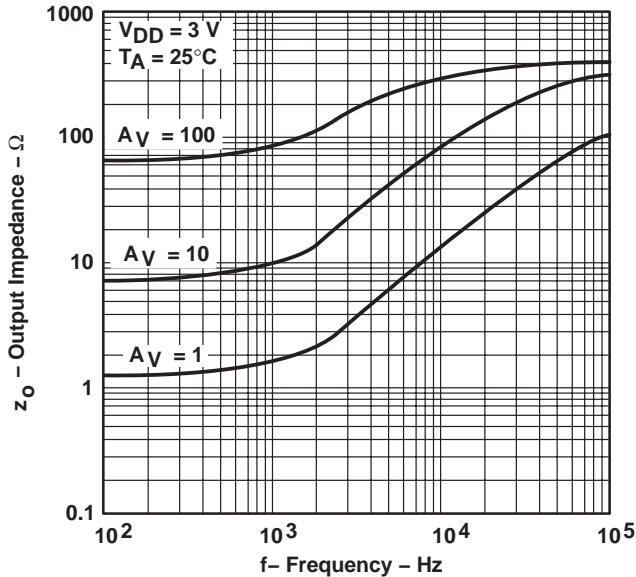

Figure 30

OUTPUT IMPEDANCE‡
vs
FREQUENCY

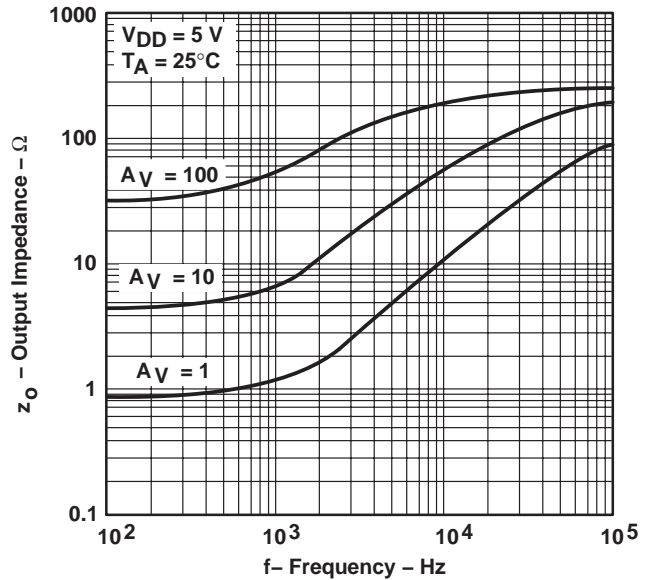

Figure 31

† Data at high and low temperatures are applicable only within the rated operating free-air temperature ranges of the various devices.

‡ For all curves where $V_{DD} = 5\text{ V}$, all loads are referenced to 2.5 V. For all curves where $V_{DD} = 3\text{ V}$, all loads are referenced to 1.5 V.



TYPICAL CHARACTERISTICS

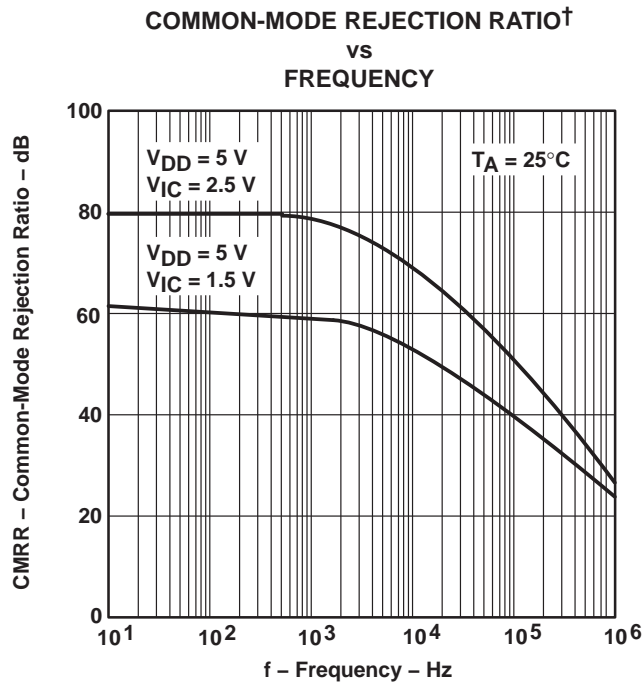

Figure 32

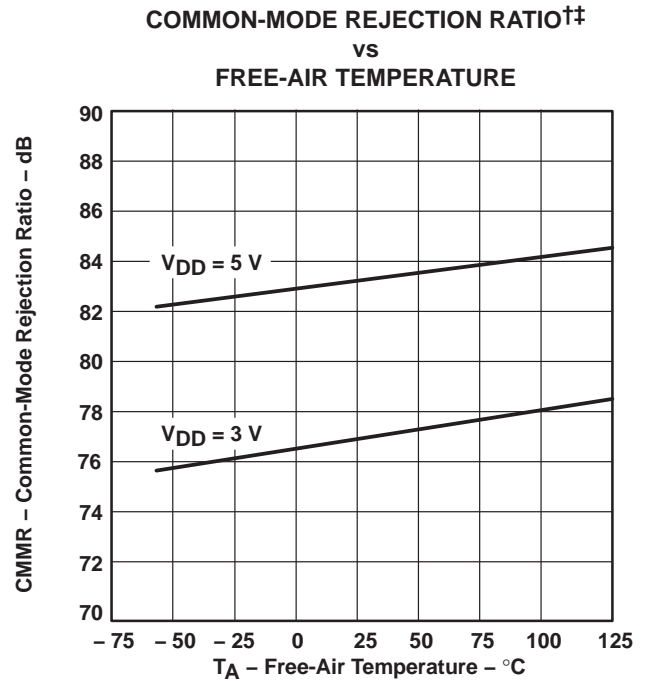

Figure 33

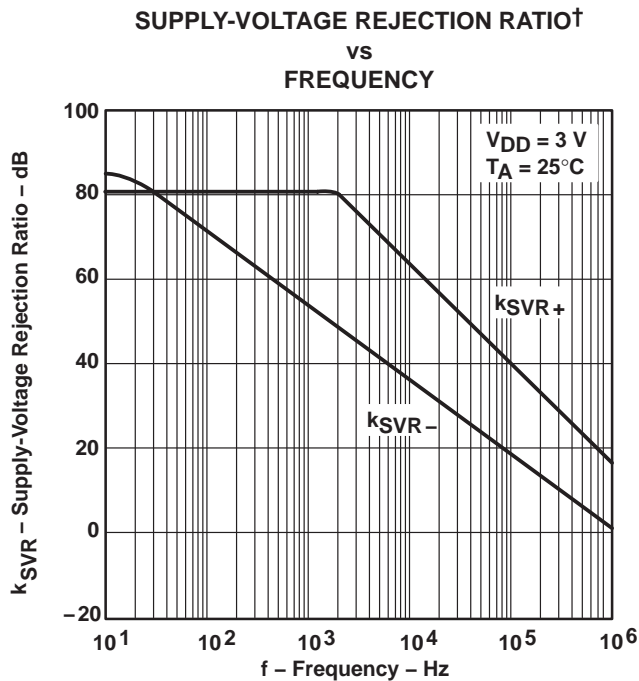

Figure 34

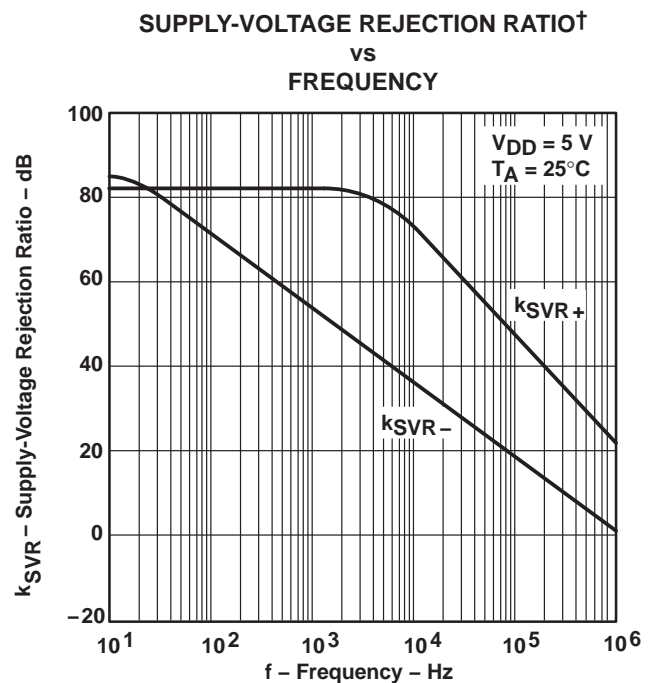

Figure 35

† For all curves where $V_{DD} = 5\text{ V}$, all loads are referenced to 2.5 V. For all curves where $V_{DD} = 3\text{ V}$, all loads are referenced to 1.5 V.
 ‡ Data at high and low temperatures are applicable only within the rated operating free-air temperature ranges of the various devices.

TYPICAL CHARACTERISTICS

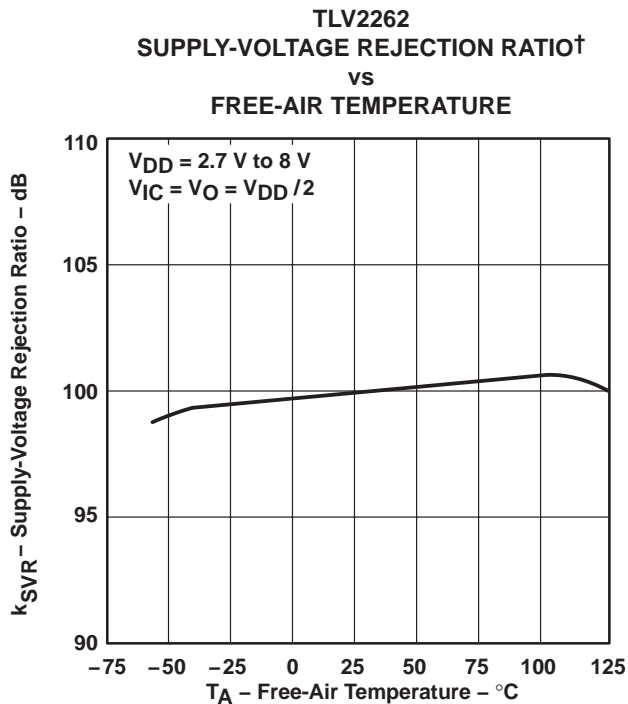

Figure 36

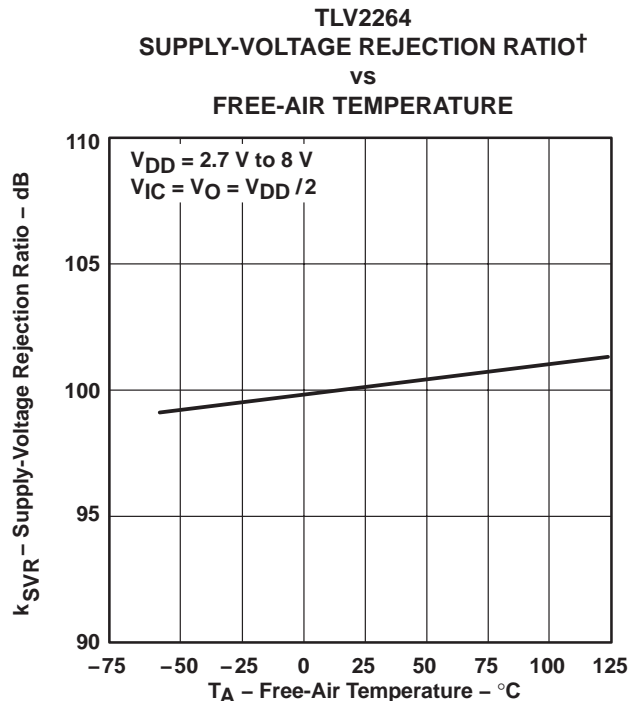

Figure 37

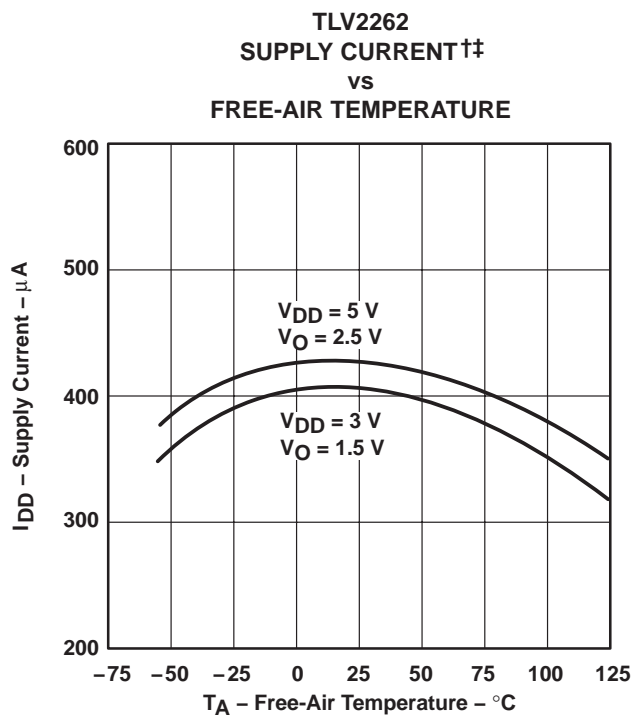

Figure 38

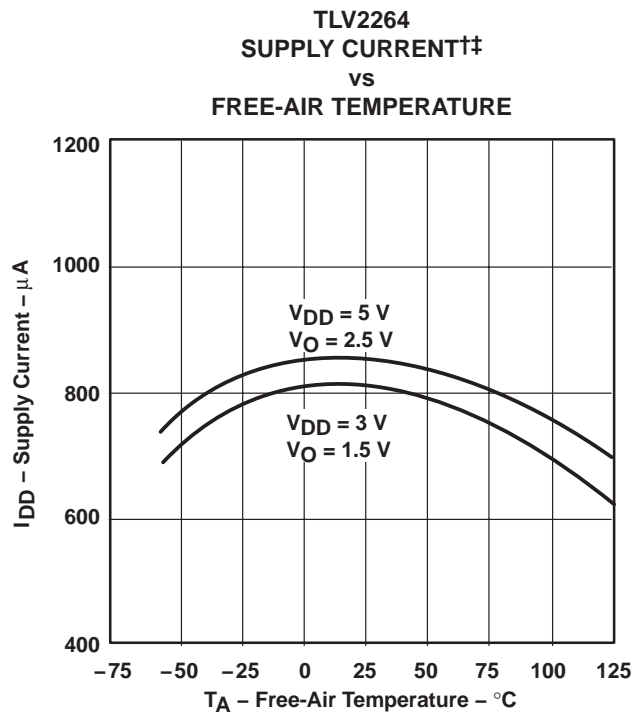
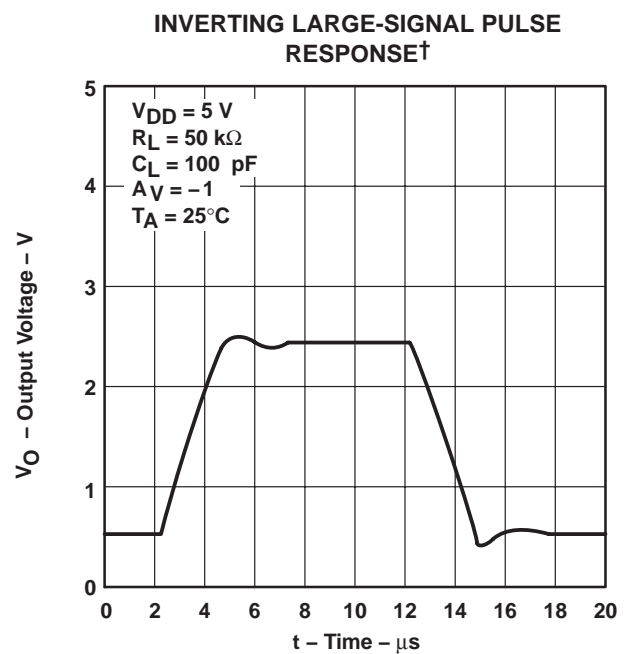
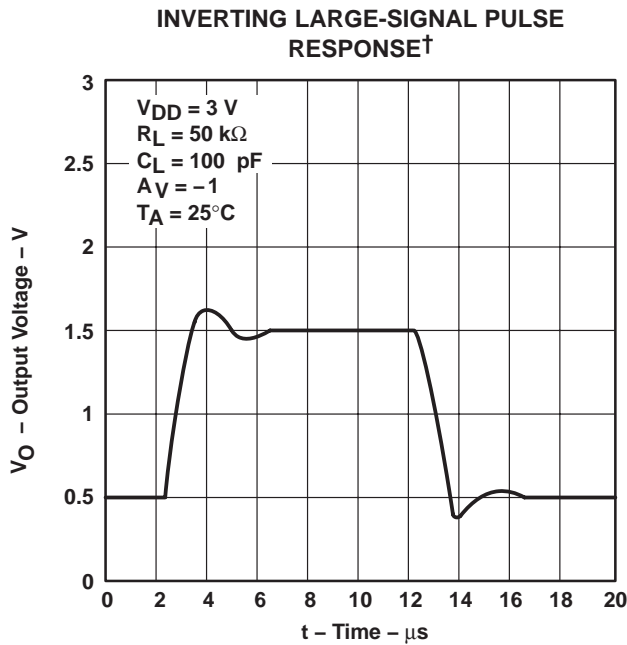
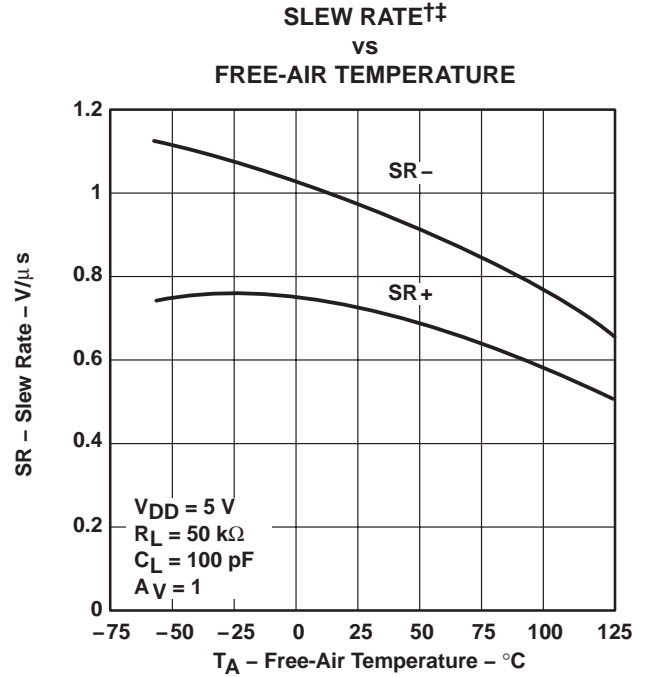
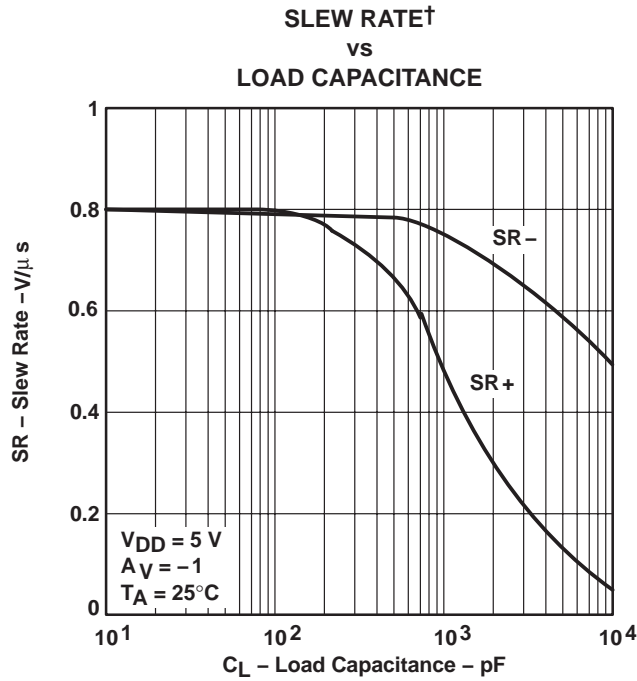

Figure 39

† Data at high and low temperatures are applicable only within the rated operating free-air temperature ranges of the various devices.

‡ For all curves where $V_{DD} = 5 \text{ V}$, all loads are referenced to 2.5 V. For all curves where $V_{DD} = 3 \text{ V}$, all loads are referenced to 1.5 V.

TYPICAL CHARACTERISTICS



† For all curves where $V_{DD} = 5\text{ V}$, all loads are referenced to 2.5 V. For all curves where $V_{DD} = 3\text{ V}$, all loads are referenced to 1.5 V.
‡ Data at high and low temperatures are applicable only within the rated operating free-air temperature ranges of the various devices.

TYPICAL CHARACTERISTICS

VOLTAGE-FOLLOWER LARGE-SIGNAL PULSE RESPONSE†

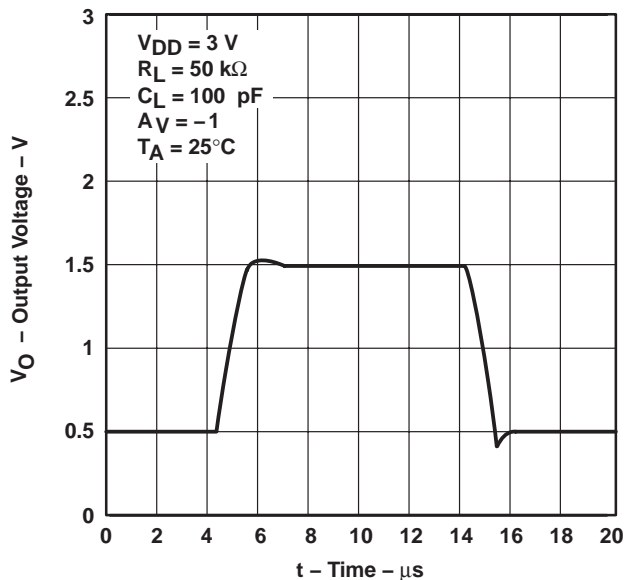

Figure 44

VOLTAGE-FOLLOWER LARGE-SIGNAL PULSE RESPONSE†

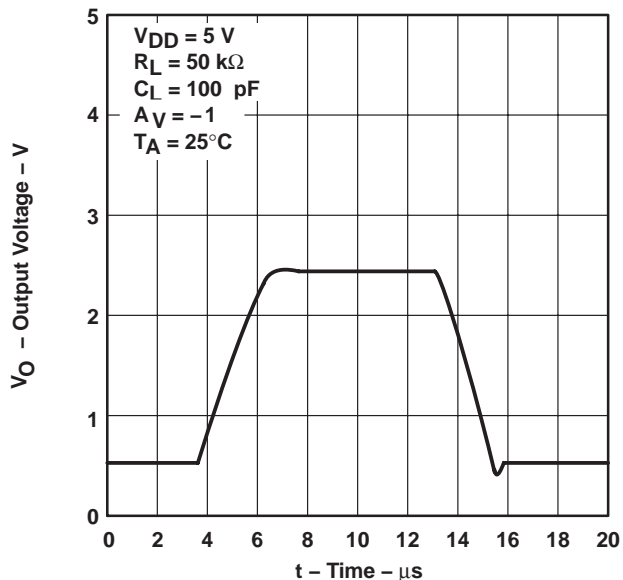

Figure 45

INVERTING SMALL-SIGNAL PULSE RESPONSE†

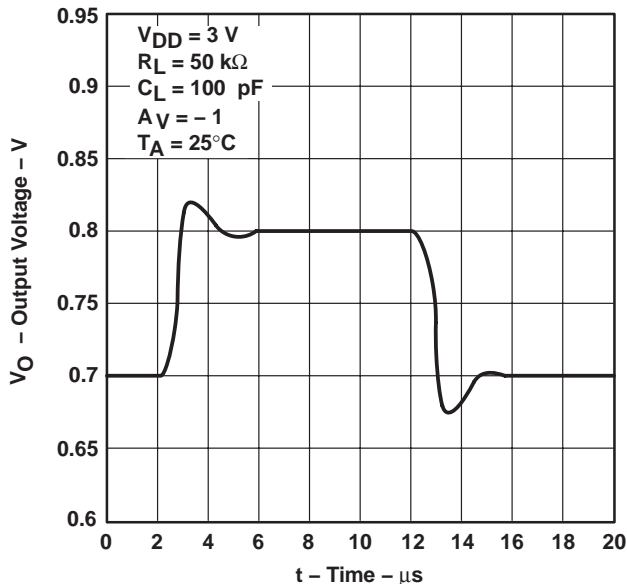

Figure 46

INVERTING SMALL-SIGNAL PULSE RESPONSE†

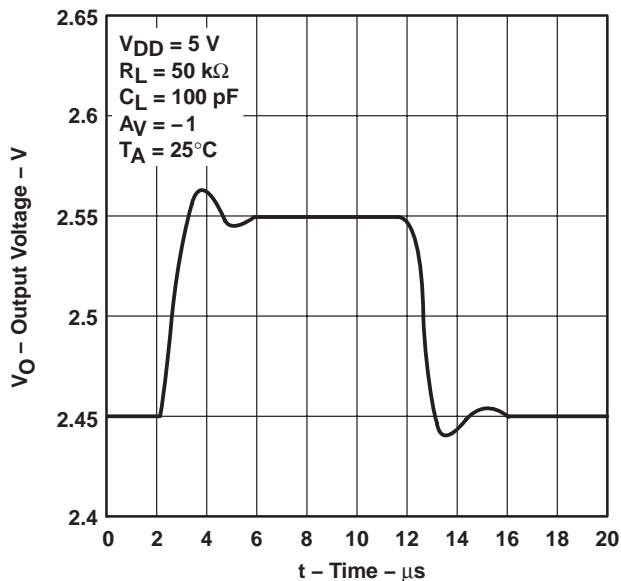

Figure 47

† For all curves where $V_{DD} = 5\text{ V}$, all loads are referenced to 2.5 V. For all curves where $V_{DD} = 3\text{ V}$, all loads are referenced to 1.5 V.

TYPICAL CHARACTERISTICS

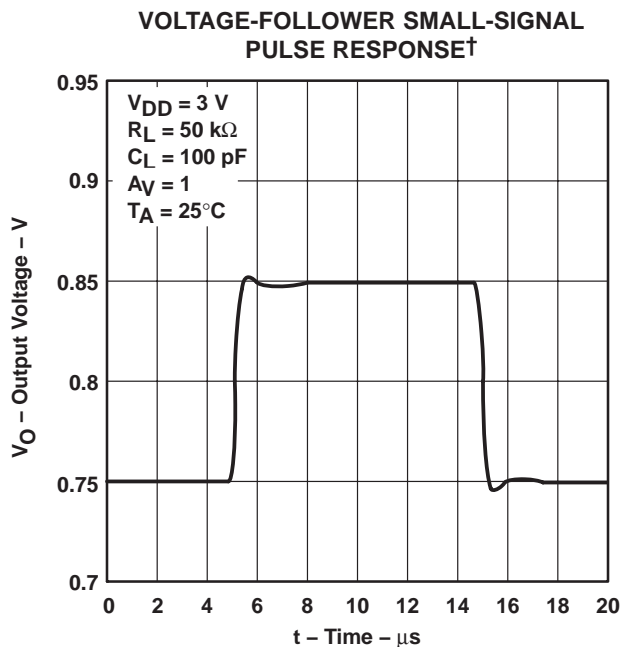

Figure 48

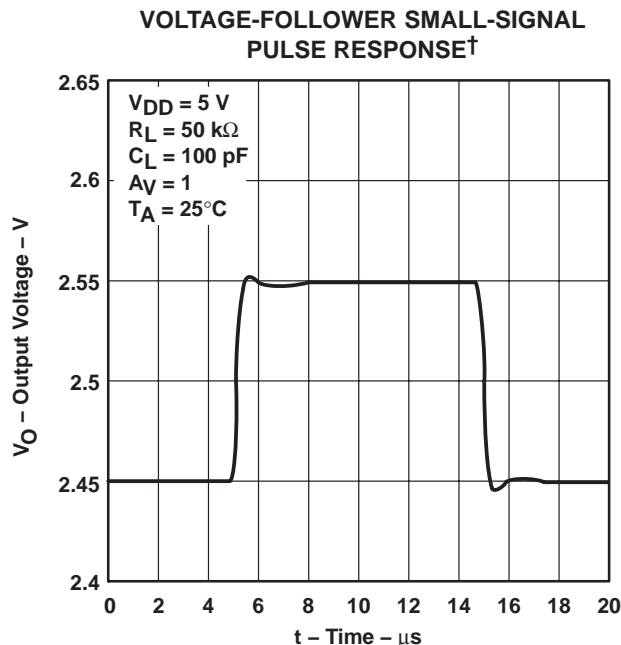

Figure 49

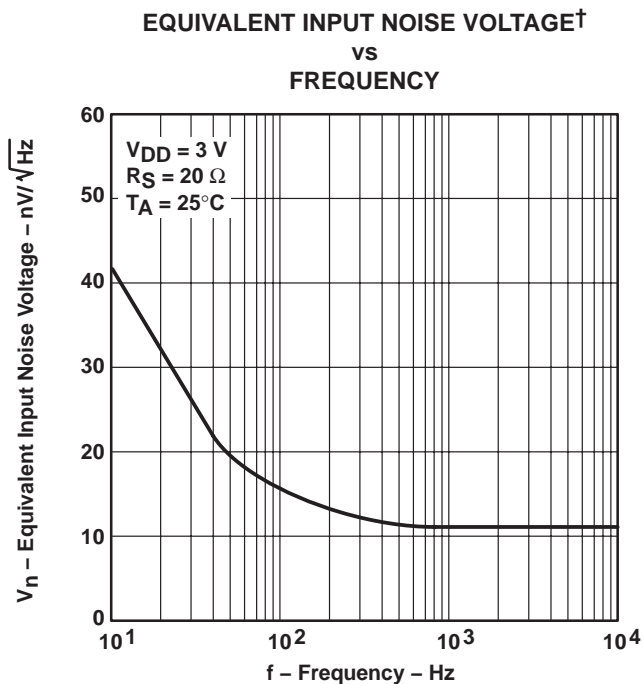

Figure 50

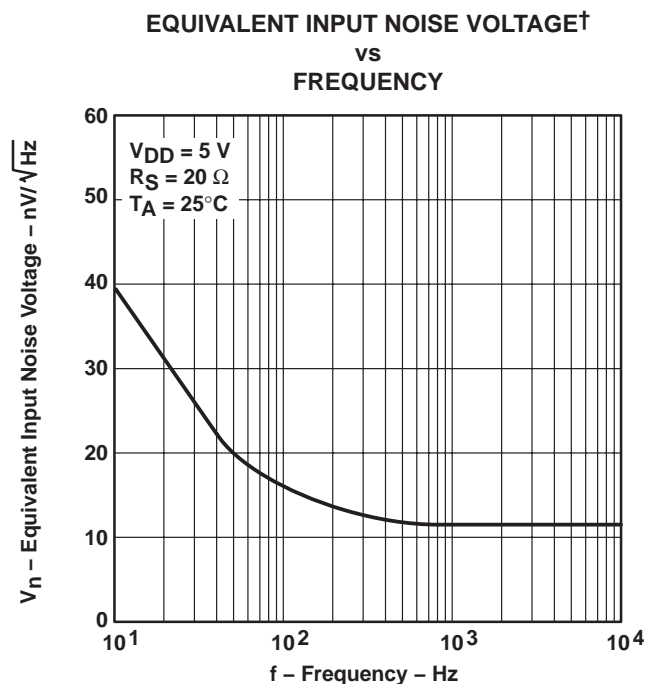

Figure 51

† For all curves where $V_{DD} = 5\text{ V}$, all loads are referenced to 2.5 V. For all curves where $V_{DD} = 3\text{ V}$, all loads are referenced to 1.5 V.

TYPICAL CHARACTERISTICS

**INPUT NOISE VOLTAGE OVER
A 10-SECOND PERIOD†**

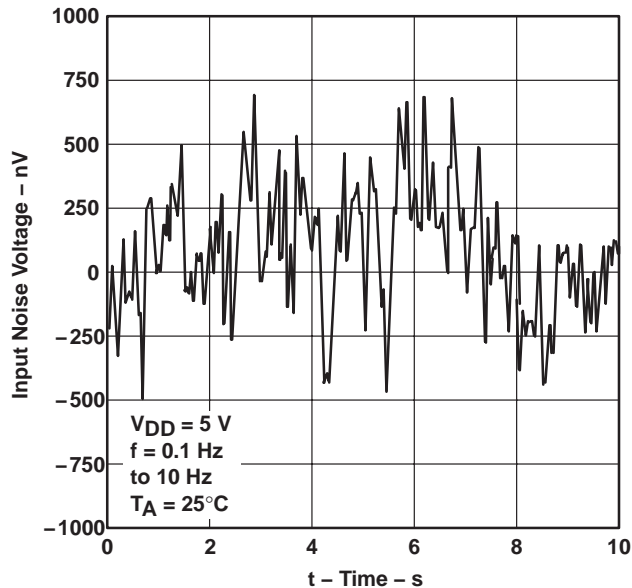

Figure 52

**INTEGRATED NOISE VOLTAGE
VS
FREQUENCY**

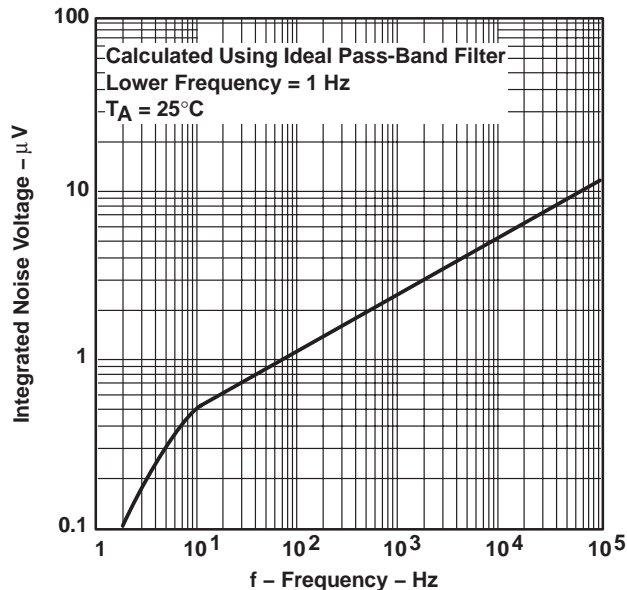

Figure 53

**TOTAL HARMONIC DISTORTION PLUS NOISE†
VS
FREQUENCY**

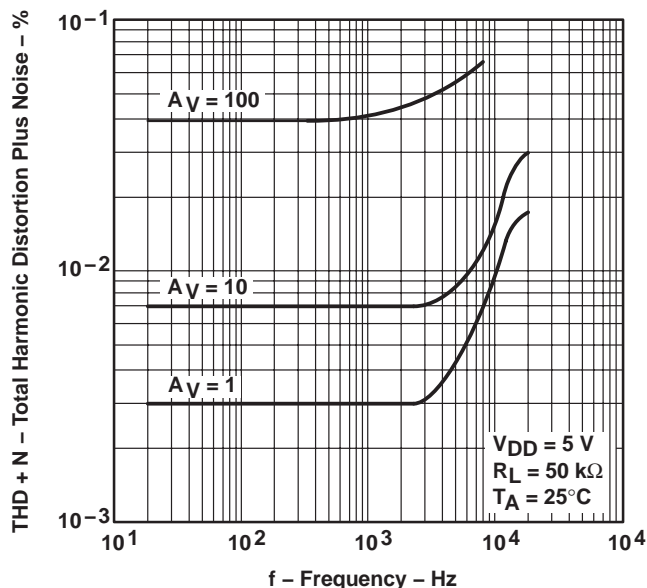

Figure 54

**GAIN-BANDWIDTH PRODUCT
VS
SUPPLY VOLTAGE**

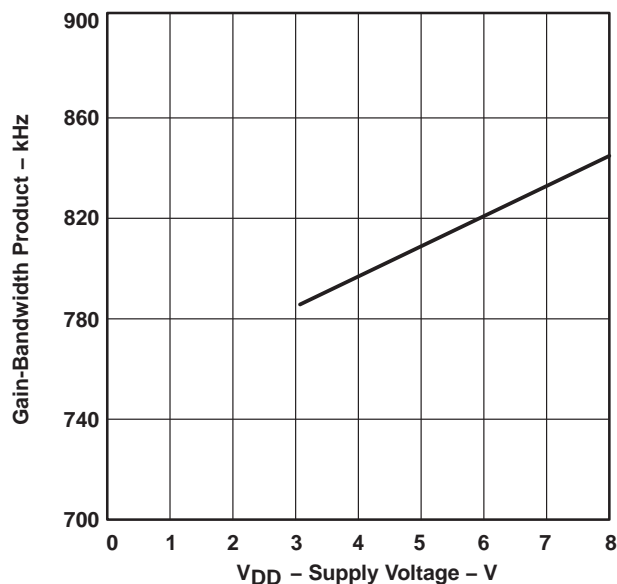

Figure 55

† For all curves where $V_{DD} = 5\text{ V}$, all loads are referenced to 2.5 V . For all curves where $V_{DD} = 3\text{ V}$, all loads are referenced to 1.5 V .

TYPICAL CHARACTERISTICS

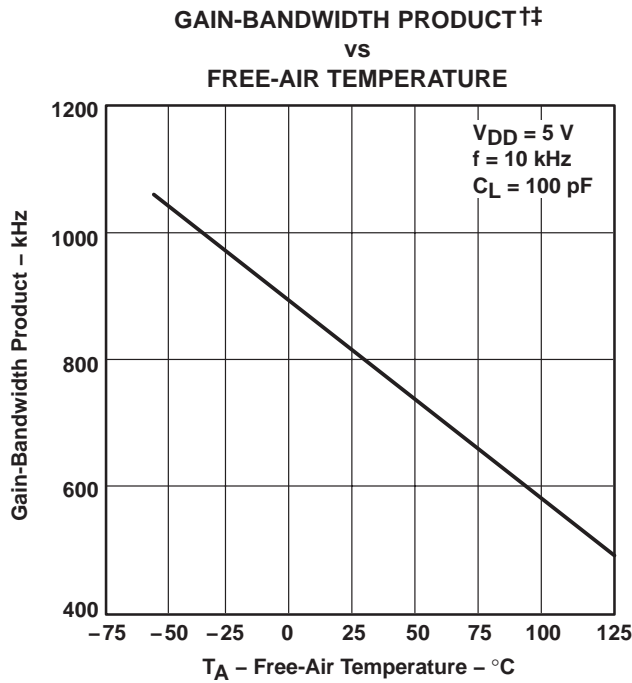

Figure 56

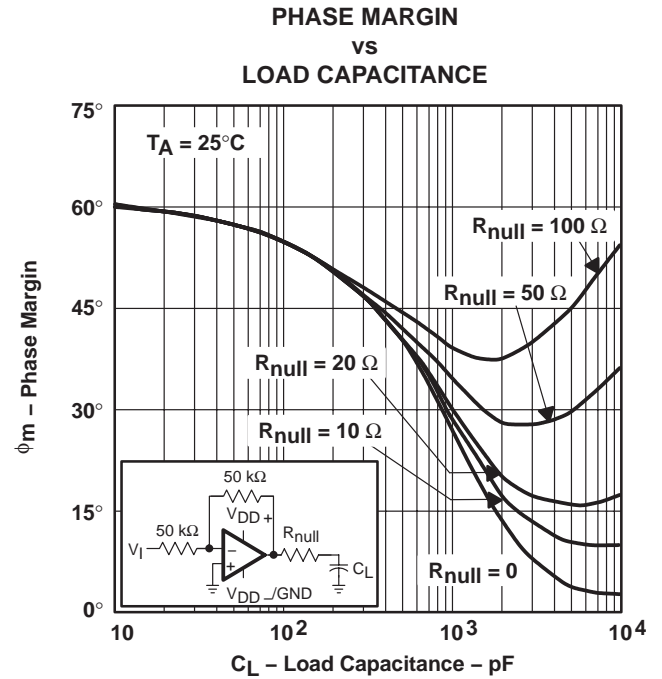

Figure 57

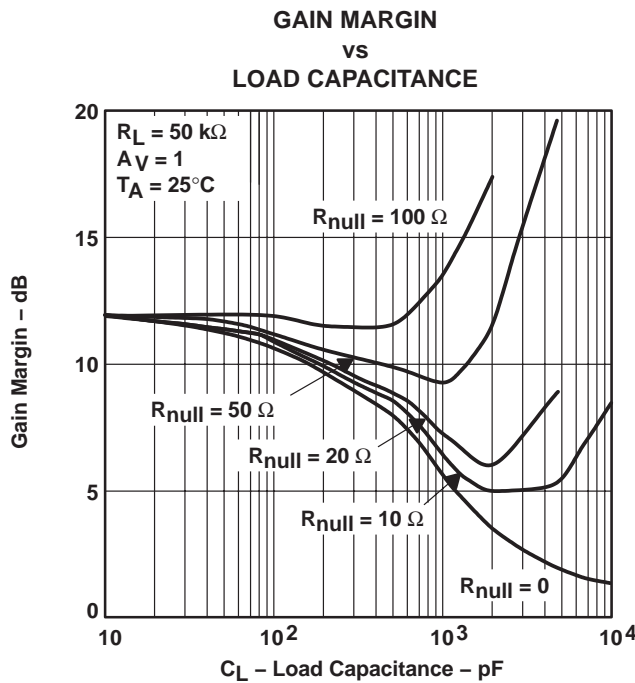

Figure 58

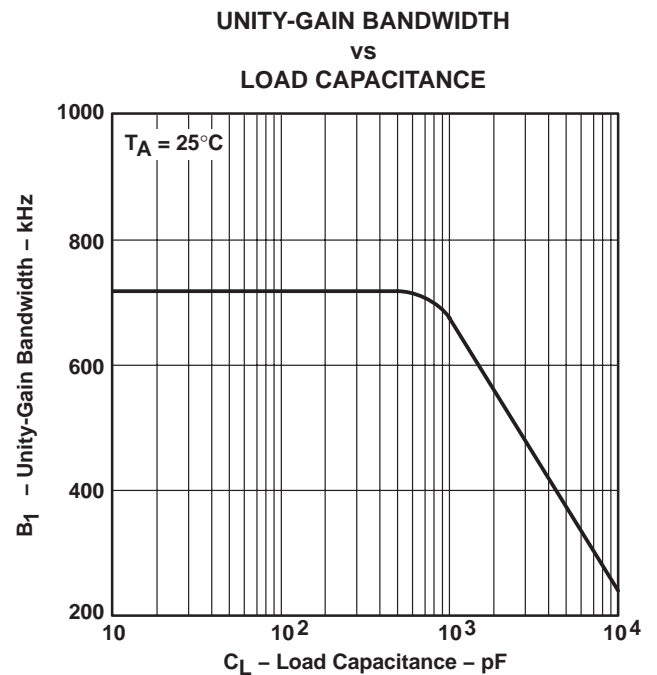
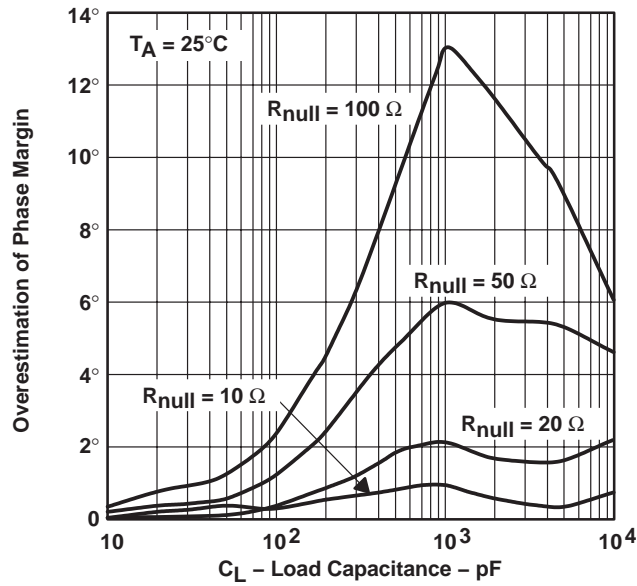

Figure 59

† For all curves where $V_{DD} = 5\text{ V}$, all loads are referenced to 2.5 V. For all curves where $V_{DD} = 3\text{ V}$, all loads are referenced to 1.5 V.
†† Data at high and low temperatures are applicable only within the rated operating free-air temperature ranges of the various devices.

TYPICAL CHARACTERISTICS

OVERESTIMATION OF PHASE MARGIN†
vs
LOAD CAPACITANCE



† See application information

Figure 60



APPLICATION INFORMATION

driving large capacitive loads

The TLV226x is designed to drive larger capacitive loads than most CMOS operational amplifiers. Figure 51 and Figure 52 illustrate its ability to drive loads greater than 400 pF while maintaining good gain and phase margins ($R_{null} = 0$).

A smaller series resistor (R_{null}) at the output of the device (see Figure 61) improves the gain and phase margins when driving large capacitive loads. Figure 51 and Figure 52 show the effects of adding series resistances of 10 Ω , 20 Ω , 50 Ω , and 100 Ω . The addition of this series resistor has two effects: the first is that it adds a zero to the transfer function and the second is that it reduces the frequency of the pole associated with the output load in the transfer function.

The zero introduced to the transfer function is equal to the series resistance times the load capacitance. To calculate the improvement in phase margin, equation (1) can be used.

$$\Delta\theta_{m1} = \tan^{-1} \left(2 \times \pi \times \text{UGBW} \times R_{null} \times C_L \right) \quad (1)$$

Where :

- $\Delta\theta_{m1}$ = improvement in phase margin
- UGBW = unity-gain bandwidth frequency
- R_{null} = output series resistance
- C_L = load capacitance

The unity-gain bandwidth (UGBW) frequency decreases as the capacitive load increases (see Figure 53). To use equation 1, UGBW must be approximated from Figure 53.

Using equation 1 alone overestimates the improvement in phase margin as illustrated in Figure 59. The overestimation is caused by the decrease in the frequency of the pole associated with the load, providing additional phase shift and reducing the overall improvement in phase margin. The pole associated with the load is reduced by the factor calculated in equation 2.

$$F = \frac{1}{1 + g_m \times R_{null}} \quad (2)$$

Where :

- F = factor reducing frequency of pole
- g_m = small-signal output transconductance (typically 4.83×10^{-3} mhos)
- R_{null} = output series resistance

For the TLV226x, the pole associated with the load is typically 7 MHz with 100-pF load capacitance. This value varies inversely with C_L : at $C_L = 10$ pF, use 70 MHz, at $C_L = 1000$ pF, use 700 kHz, and so on.

Reducing the pole associated with the load introduces phase shift, thereby reducing phase margin. This results in an error in the increase in phase margin expected by considering the zero alone (equation 1). Equation 3 approximates the reduction in phase margin due to the movement of the pole associated with the load. The result of this equation can be subtracted from the result of the equation 1 to better approximate the improvement in phase margin.

APPLICATION INFORMATION

driving large capacitive loads (continued)

$$\Delta\theta_{m2} = \tan^{-1} \left[\frac{UGBW}{(F \times P_2)} \right] - \tan^{-1} \left(\frac{UGBW}{P_2} \right) \tag{3}$$

Where :

$\Delta\theta_{m2}$ = reduction in phase margin

UGBW = unity-gain bandwidth frequency

F = factor from equation (2)

P_2 = unadjusted pole (70 MHz @ 10 pF, 7 MHz @ 100 pF, etc.)

Using these equations with Figure 60 and Figure 61 enables the designer to choose the appropriate output series resistance to optimize the design of circuits driving large capacitive loads.

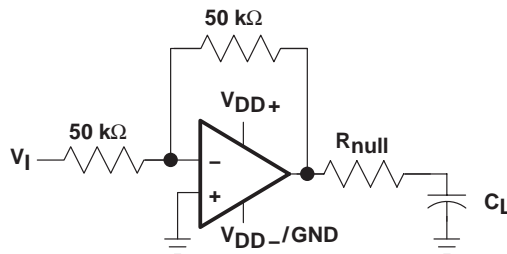

Figure 61. Series-Resistance Circuit

APPLICATION INFORMATION

macromodel information

Macromodel information provided was derived using Microsim *Parts*™, the model generation software used with Microsim *PSPice*™. The Boyle macromodel (see Note 5) and subcircuit in Figure 62 are generated using the TLV226x typical electrical and operating characteristics at $T_A = 25^\circ\text{C}$. Using this information, output simulations of the following key parameters can be generated to a tolerance of 20% (in most cases):

- Maximum positive output voltage swing
 - Maximum negative output voltage swing
 - Slew rate
 - Quiescent power dissipation
 - Input bias current
 - Open-loop voltage amplification
- Unity-gain frequency
 - Common-mode rejection ratio
 - Phase margin
 - DC output resistance
 - AC output resistance
 - Short-circuit output current limit

NOTE 5: G. R. Boyle, B. M. Cohn, D. O. Pederson, and J. E. Solomon, "Macromodeling of Intergrated Circuit Operational Amplifiers," *IEEE Journal of Solid-State Circuits*, SC-9, 353 (1974).

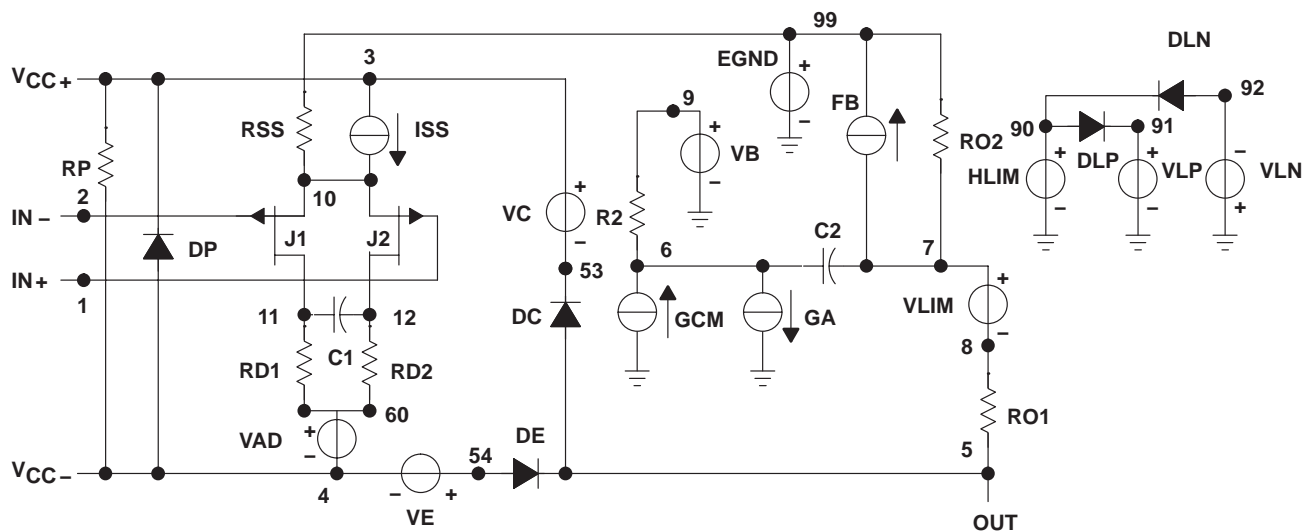

<pre>.SUBCKT TLV226x 1 2 3 4 5 C1 11 12 5.5E-12 C2 6 7 20.00E-12 DC 5 53 DX DE 54 5 DX DLP 90 91 DX DLN 92 90 DX DP 4 3 DX EGND 99 0 POLY (2) (3,0) (4,0) 0 .5 .5 FB 7 99 POLY (5) VB VC VE VLP + VLN 0 8.84E6 -10E6 10E6 10E6 -10E6 GA 6 0 11 12 62.83E-6 GCM 0 6 10 99 12.34E-9 ISS 3 10 DC 11.05E-6 HLIM 90 0 VLIM 1K J1 11 2 10 JX J2 12 1 10 JX R2 6 9 100.0E3</pre>	<pre>RD1 60 11 15.92E3 RD2 60 12 15.92E3 R01 8 5 135 R02 7 99 135 RP 3 4 15.87E3 RSS 10 99 18.18E6 VAD 60 4 -.5 VB 9 0 DC 0 VC 3 53 DC .615 VE 54 4 DC .615 VLIM 7 8 DC 0 VLP 91 0 DC 1 VLN 0 92 DC 5.1 .MODEL DX D (IS=800.0E-18) .MODEL JX PJF (IS=500.0E-15 BETA=325E-6 + VTO=-.08) .ENDS</pre>
---	---

Figure 62. Boyle Macromodel and Subcircuit

PSPice and *Parts* are trademarks of MicroSim Corporation.

PACKAGING INFORMATION

Orderable Device	Status ⁽¹⁾	Package Type	Package Drawing	Pins	Package Qty	Eco Plan ⁽²⁾	Lead/Ball Finish	MSL Peak Temp ⁽³⁾
5962-9550401Q2A	ACTIVE	LCCC	FK	20	1	TBD	POST-PLATE	N / A for Pkg Type
5962-9550401QHA	ACTIVE	CFP	U	10	1	TBD	A42	N / A for Pkg Type
5962-9550401QPA	ACTIVE	CDIP	JG	8	1	TBD	A42	N / A for Pkg Type
5962-9550402Q2A	ACTIVE	LCCC	FK	20	1	TBD	POST-PLATE	N / A for Pkg Type
5962-9550402QCA	ACTIVE	CDIP	J	14	1	TBD	A42	N / A for Pkg Type
5962-9550402QDA	ACTIVE	CFP	W	14	1	TBD	A42	N / A for Pkg Type
5962-9550403Q2A	ACTIVE	LCCC	FK	20	1	TBD	POST-PLATE	N / A for Pkg Type
5962-9550403QHA	ACTIVE	CFP	U	10	1	TBD	A42	N / A for Pkg Type
5962-9550403QPA	ACTIVE	CDIP	JG	8	1	TBD	A42	N / A for Pkg Type
5962-9550404Q2A	ACTIVE	LCCC	FK	20	1	TBD	POST-PLATE	N / A for Pkg Type
5962-9550404QCA	ACTIVE	CDIP	J	14	1	TBD	A42	N / A for Pkg Type
5962-9550404QDA	ACTIVE	CFP	W	14	1	TBD	A42	N / A for Pkg Type
TLV2262AID	ACTIVE	SOIC	D	8	75	Green (RoHS & no Sb/Br)	CU NIPDAU	Level-1-260C-UNLIM
TLV2262AIDG4	ACTIVE	SOIC	D	8	75	Green (RoHS & no Sb/Br)	CU NIPDAU	Level-1-260C-UNLIM
TLV2262AIDR	ACTIVE	SOIC	D	8	2500	Green (RoHS & no Sb/Br)	CU NIPDAU	Level-1-260C-UNLIM
TLV2262AIDRG4	ACTIVE	SOIC	D	8	2500	Green (RoHS & no Sb/Br)	CU NIPDAU	Level-1-260C-UNLIM
TLV2262AIP	ACTIVE	PDIP	P	8	50	Pb-Free (RoHS)	CU NIPDAU	N / A for Pkg Type
TLV2262AIPe4	ACTIVE	PDIP	P	8	50	Pb-Free (RoHS)	CU NIPDAU	N / A for Pkg Type
TLV2262AIPW	ACTIVE	TSSOP	PW	8	150	Green (RoHS & no Sb/Br)	CU NIPDAU	Level-1-260C-UNLIM
TLV2262AIPWG4	ACTIVE	TSSOP	PW	8	150	Green (RoHS & no Sb/Br)	CU NIPDAU	Level-1-260C-UNLIM
TLV2262AIPWLE	OBSOLETE	TSSOP	PW	8		TBD	Call TI	Call TI
TLV2262AIPWR	ACTIVE	TSSOP	PW	8	2000	Green (RoHS & no Sb/Br)	CU NIPDAU	Level-1-260C-UNLIM
TLV2262AIPWRG4	ACTIVE	TSSOP	PW	8	2000	Green (RoHS & no Sb/Br)	CU NIPDAU	Level-1-260C-UNLIM
TLV2262AMFKB	ACTIVE	LCCC	FK	20	1	TBD	POST-PLATE	N / A for Pkg Type
TLV2262AMJGB	ACTIVE	CDIP	JG	8	1	TBD	A42	N / A for Pkg Type
TLV2262AMUB	ACTIVE	CFP	U	10	1	TBD	A42	N / A for Pkg Type
TLV2262AQD	ACTIVE	SOIC	D	8	75	Green (RoHS & no Sb/Br)	CU NIPDAU	Level-1-260C-UNLIM
TLV2262AQDG4	ACTIVE	SOIC	D	8	75	Green (RoHS & no Sb/Br)	CU NIPDAU	Level-1-260C-UNLIM
TLV2262AQDR	ACTIVE	SOIC	D	8	2500	Green (RoHS & no Sb/Br)	CU NIPDAU	Level-1-260C-UNLIM
TLV2262AQDRG4	ACTIVE	SOIC	D	8	2500	Green (RoHS & no Sb/Br)	CU NIPDAU	Level-1-260C-UNLIM
TLV2262ID	ACTIVE	SOIC	D	8	75	Green (RoHS & no Sb/Br)	CU NIPDAU	Level-1-260C-UNLIM
TLV2262IDG4	ACTIVE	SOIC	D	8	75	Green (RoHS & no Sb/Br)	CU NIPDAU	Level-1-260C-UNLIM

Orderable Device	Status ⁽¹⁾	Package Type	Package Drawing	Pins	Package Qty	Eco Plan ⁽²⁾	Lead/Ball Finish	MSL Peak Temp ⁽³⁾
						no Sb/Br)		
TLV2262IDR	ACTIVE	SOIC	D	8	2500	Green (RoHS & no Sb/Br)	CU NIPDAU	Level-1-260C-UNLIM
TLV2262IDRG4	ACTIVE	SOIC	D	8	2500	Green (RoHS & no Sb/Br)	CU NIPDAU	Level-1-260C-UNLIM
TLV2262IP	ACTIVE	PDIP	P	8	50	Pb-Free (RoHS)	CU NIPDAU	N / A for Pkg Type
TLV2262IPE4	ACTIVE	PDIP	P	8	50	Pb-Free (RoHS)	CU NIPDAU	N / A for Pkg Type
TLV2262IPW	ACTIVE	TSSOP	PW	8	150	Green (RoHS & no Sb/Br)	CU NIPDAU	Level-1-260C-UNLIM
TLV2262IPWG4	ACTIVE	TSSOP	PW	8	150	Green (RoHS & no Sb/Br)	CU NIPDAU	Level-1-260C-UNLIM
TLV2262IPWR	ACTIVE	TSSOP	PW	8	2000	Green (RoHS & no Sb/Br)	CU NIPDAU	Level-1-260C-UNLIM
TLV2262IPWRG4	ACTIVE	TSSOP	PW	8	2000	Green (RoHS & no Sb/Br)	CU NIPDAU	Level-1-260C-UNLIM
TLV2262MFKB	ACTIVE	LCCC	FK	20	1	TBD	POST-PLATE	N / A for Pkg Type
TLV2262MJGB	ACTIVE	CDIP	JG	8	1	TBD	A42	N / A for Pkg Type
TLV2262MUB	ACTIVE	CFP	U	10	1	TBD	A42	N / A for Pkg Type
TLV2262QD	ACTIVE	SOIC	D	8	75	Green (RoHS & no Sb/Br)	CU NIPDAU	Level-1-260C-UNLIM
TLV2262QDG4	ACTIVE	SOIC	D	8	1500	Green (RoHS & no Sb/Br)	CU NIPDAU	Level-1-260C-UNLIM
TLV2262QDR	ACTIVE	SOIC	D	8	2500	Green (RoHS & no Sb/Br)	CU NIPDAU	Level-1-260C-UNLIM
TLV2262QDRG4	ACTIVE	SOIC	D	8	2500	Green (RoHS & no Sb/Br)	CU NIPDAU	Level-1-260C-UNLIM
TLV2264AID	ACTIVE	SOIC	D	14	50	Green (RoHS & no Sb/Br)	CU NIPDAU	Level-1-260C-UNLIM
TLV2264AIDG4	ACTIVE	SOIC	D	14	50	Green (RoHS & no Sb/Br)	CU NIPDAU	Level-1-260C-UNLIM
TLV2264AIDR	ACTIVE	SOIC	D	14	2500	Green (RoHS & no Sb/Br)	CU NIPDAU	Level-1-260C-UNLIM
TLV2264AIDRG4	ACTIVE	SOIC	D	14	2500	Green (RoHS & no Sb/Br)	CU NIPDAU	Level-1-260C-UNLIM
TLV2264AIN	ACTIVE	PDIP	N	14	25	Pb-Free (RoHS)	CU NIPDAU	N / A for Pkg Type
TLV2264AINE4	ACTIVE	PDIP	N	14	25	Pb-Free (RoHS)	CU NIPDAU	N / A for Pkg Type
TLV2264AIPW	ACTIVE	TSSOP	PW	14	90	Green (RoHS & no Sb/Br)	CU NIPDAU	Level-1-260C-UNLIM
TLV2264AIPWG4	ACTIVE	TSSOP	PW	14	90	Green (RoHS & no Sb/Br)	CU NIPDAU	Level-1-260C-UNLIM
TLV2264AIPWLE	OBSOLETE	TSSOP	PW	14		TBD	Call TI	Call TI
TLV2264AIPWR	ACTIVE	TSSOP	PW	14	2000	Green (RoHS & no Sb/Br)	CU NIPDAU	Level-1-260C-UNLIM
TLV2264AIPWRG4	ACTIVE	TSSOP	PW	14	2000	Green (RoHS & no Sb/Br)	CU NIPDAU	Level-1-260C-UNLIM
TLV2264AMFKB	ACTIVE	LCCC	FK	20	1	TBD	POST-PLATE	N / A for Pkg Type

Orderable Device	Status ⁽¹⁾	Package Type	Package Drawing	Pins	Package Qty	Eco Plan ⁽²⁾	Lead/Ball Finish	MSL Peak Temp ⁽³⁾
TLV2264AMJB	ACTIVE	CDIP	J	14	1	TBD	A42	N / A for Pkg Type
TLV2264AMWB	ACTIVE	CFP	W	14	1	TBD	A42	N / A for Pkg Type
TLV2264AQD	ACTIVE	SOIC	D	14	50	TBD	CU NIPDAU	Level-1-220C-UNLIM
TLV2264AQDG4	ACTIVE	SOIC	D	14	50	Green (RoHS & no Sb/Br)	CU NIPDAU	Level-1-260C-UNLIM
TLV2264AQDR	ACTIVE	SOIC	D	14	2500	TBD	CU NIPDAU	Level-1-220C-UNLIM
TLV2264AQDRG4	ACTIVE	SOIC	D	14	2500	Green (RoHS & no Sb/Br)	CU NIPDAU	Level-1-260C-UNLIM
TLV2264ID	ACTIVE	SOIC	D	14	50	Green (RoHS & no Sb/Br)	CU NIPDAU	Level-1-260C-UNLIM
TLV2264IDG4	ACTIVE	SOIC	D	14	50	Green (RoHS & no Sb/Br)	CU NIPDAU	Level-1-260C-UNLIM
TLV2264IDR	ACTIVE	SOIC	D	14	2500	Green (RoHS & no Sb/Br)	CU NIPDAU	Level-1-260C-UNLIM
TLV2264IDRG4	ACTIVE	SOIC	D	14	2500	Green (RoHS & no Sb/Br)	CU NIPDAU	Level-1-260C-UNLIM
TLV2264IN	ACTIVE	PDIP	N	14	25	Pb-Free (RoHS)	CU NIPDAU	N / A for Pkg Type
TLV2264INE4	ACTIVE	PDIP	N	14	25	Pb-Free (RoHS)	CU NIPDAU	N / A for Pkg Type
TLV2264IPWR	ACTIVE	TSSOP	PW	14	2000	Green (RoHS & no Sb/Br)	CU NIPDAU	Level-1-260C-UNLIM
TLV2264IPWRG4	ACTIVE	TSSOP	PW	14	2000	Green (RoHS & no Sb/Br)	CU NIPDAU	Level-1-260C-UNLIM
TLV2264MFKB	ACTIVE	LCCC	FK	20	1	TBD	POST-PLATE	N / A for Pkg Type
TLV2264MJB	ACTIVE	CDIP	J	14	1	TBD	A42	N / A for Pkg Type
TLV2264MWB	ACTIVE	CFP	W	14	1	TBD	A42	N / A for Pkg Type
TLV2264QD	ACTIVE	SOIC	D	14	50	TBD	CU NIPDAU	Level-1-220C-UNLIM
TLV2264QDG4	ACTIVE	SOIC	D	14	50	Green (RoHS & no Sb/Br)	CU NIPDAU	Level-1-260C-UNLIM
TLV2264QDR	ACTIVE	SOIC	D	14	2500	TBD	CU NIPDAU	Level-1-220C-UNLIM
TLV2264QDRG4	ACTIVE	SOIC	D	14	2500	Green (RoHS & no Sb/Br)	CU NIPDAU	Level-1-260C-UNLIM

⁽¹⁾ The marketing status values are defined as follows:

ACTIVE: Product device recommended for new designs.

LIFEBUY: TI has announced that the device will be discontinued, and a lifetime-buy period is in effect.

NRND: Not recommended for new designs. Device is in production to support existing customers, but TI does not recommend using this part in a new design.

PREVIEW: Device has been announced but is not in production. Samples may or may not be available.

OBsolete: TI has discontinued the production of the device.

⁽²⁾ Eco Plan - The planned eco-friendly classification: Pb-Free (RoHS), Pb-Free (RoHS Exempt), or Green (RoHS & no Sb/Br) - please check <http://www.ti.com/productcontent> for the latest availability information and additional product content details.

TBD: The Pb-Free/Green conversion plan has not been defined.

Pb-Free (RoHS): TI's terms "Lead-Free" or "Pb-Free" mean semiconductor products that are compatible with the current RoHS requirements for all 6 substances, including the requirement that lead not exceed 0.1% by weight in homogeneous materials. Where designed to be soldered at high temperatures, TI Pb-Free products are suitable for use in specified lead-free processes.

Pb-Free (RoHS Exempt): This component has a RoHS exemption for either 1) lead-based flip-chip solder bumps used between the die and package, or 2) lead-based die adhesive used between the die and leadframe. The component is otherwise considered Pb-Free (RoHS compatible) as defined above.

Green (RoHS & no Sb/Br): TI defines "Green" to mean Pb-Free (RoHS compatible), and free of Bromine (Br) and Antimony (Sb) based flame retardants (Br or Sb do not exceed 0.1% by weight in homogeneous material)

(3) MSL, Peak Temp. -- The Moisture Sensitivity Level rating according to the JEDEC industry standard classifications, and peak solder temperature.

Important Information and Disclaimer:The information provided on this page represents TI's knowledge and belief as of the date that it is provided. TI bases its knowledge and belief on information provided by third parties, and makes no representation or warranty as to the accuracy of such information. Efforts are underway to better integrate information from third parties. TI has taken and continues to take reasonable steps to provide representative and accurate information but may not have conducted destructive testing or chemical analysis on incoming materials and chemicals. TI and TI suppliers consider certain information to be proprietary, and thus CAS numbers and other limited information may not be available for release.

In no event shall TI's liability arising out of such information exceed the total purchase price of the TI part(s) at issue in this document sold by TI to Customer on an annual basis.

OTHER QUALIFIED VERSIONS OF TLV2262, TLV2262A, TLV2262AM, TLV2262M, TLV2264, TLV2264A, TLV2264AM, TLV2264M :

- Automotive: [TLV2262-Q1](#), [TLV2262A-Q1](#), [TLV2264-Q1](#), [TLV2264A-Q1](#)

NOTE: Qualified Version Definitions:

- Automotive - Q100 devices qualified for high-reliability automotive applications targeting zero defects

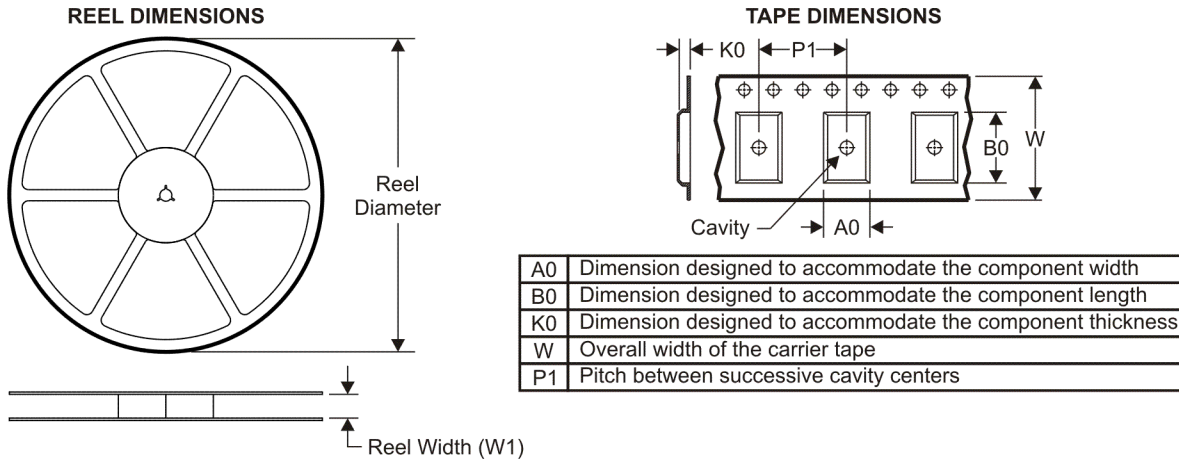
TAPE AND REEL INFORMATION

QUADRANT ASSIGNMENTS FOR PIN 1 ORIENTATION IN TAPE

*All dimensions are nominal

Device	Package Type	Package Drawing	Pins	SPQ	Reel Diameter (mm)	Reel Width W1 (mm)	A0 (mm)	B0 (mm)	K0 (mm)	P1 (mm)	W (mm)	Pin1 Quadrant
TLV2262AIDR	SOIC	D	8	2500	330.0	12.4	6.4	5.2	2.1	8.0	12.0	Q1
TLV2262AIPWR	TSSOP	PW	8	2000	330.0	12.4	7.0	3.6	1.6	8.0	12.0	Q1
TLV2262IDR	SOIC	D	8	2500	330.0	12.4	6.4	5.2	2.1	8.0	12.0	Q1
TLV2262IPWR	TSSOP	PW	8	2000	330.0	12.4	7.0	3.6	1.6	8.0	12.0	Q1
TLV2264AIDR	SOIC	D	14	2500	330.0	16.4	6.5	9.0	2.1	8.0	16.0	Q1
TLV2264AIPWR	TSSOP	PW	14	2000	330.0	12.4	6.9	5.6	1.6	8.0	12.0	Q1
TLV2264AQDR	SOIC	D	14	2500	330.0	16.4	6.5	9.0	2.1	8.0	16.0	Q1
TLV2264IDR	SOIC	D	14	2500	330.0	16.4	6.5	9.0	2.1	8.0	16.0	Q1
TLV2264IPWR	TSSOP	PW	14	2000	330.0	12.4	6.9	5.6	1.6	8.0	12.0	Q1
TLV2264QDR	SOIC	D	14	2500	330.0	16.4	6.5	9.0	2.1	8.0	16.0	Q1

TAPE AND REEL BOX DIMENSIONS

*All dimensions are nominal

Device	Package Type	Package Drawing	Pins	SPQ	Length (mm)	Width (mm)	Height (mm)
TLV2262AIDR	SOIC	D	8	2500	340.5	338.1	20.6
TLV2262AIPWR	TSSOP	PW	8	2000	346.0	346.0	29.0
TLV2262IDR	SOIC	D	8	2500	340.5	338.1	20.6
TLV2262IPWR	TSSOP	PW	8	2000	346.0	346.0	29.0
TLV2264AIDR	SOIC	D	14	2500	333.2	345.9	28.6
TLV2264AIPWR	TSSOP	PW	14	2000	346.0	346.0	29.0
TLV2264AQDR	SOIC	D	14	2500	346.0	346.0	33.0
TLV2264IDR	SOIC	D	14	2500	333.2	345.9	28.6
TLV2264IPWR	TSSOP	PW	14	2000	346.0	346.0	29.0
TLV2264QDR	SOIC	D	14	2500	346.0	346.0	33.0

JG (R-GDIP-T8)

CERAMIC DUAL-IN-LINE

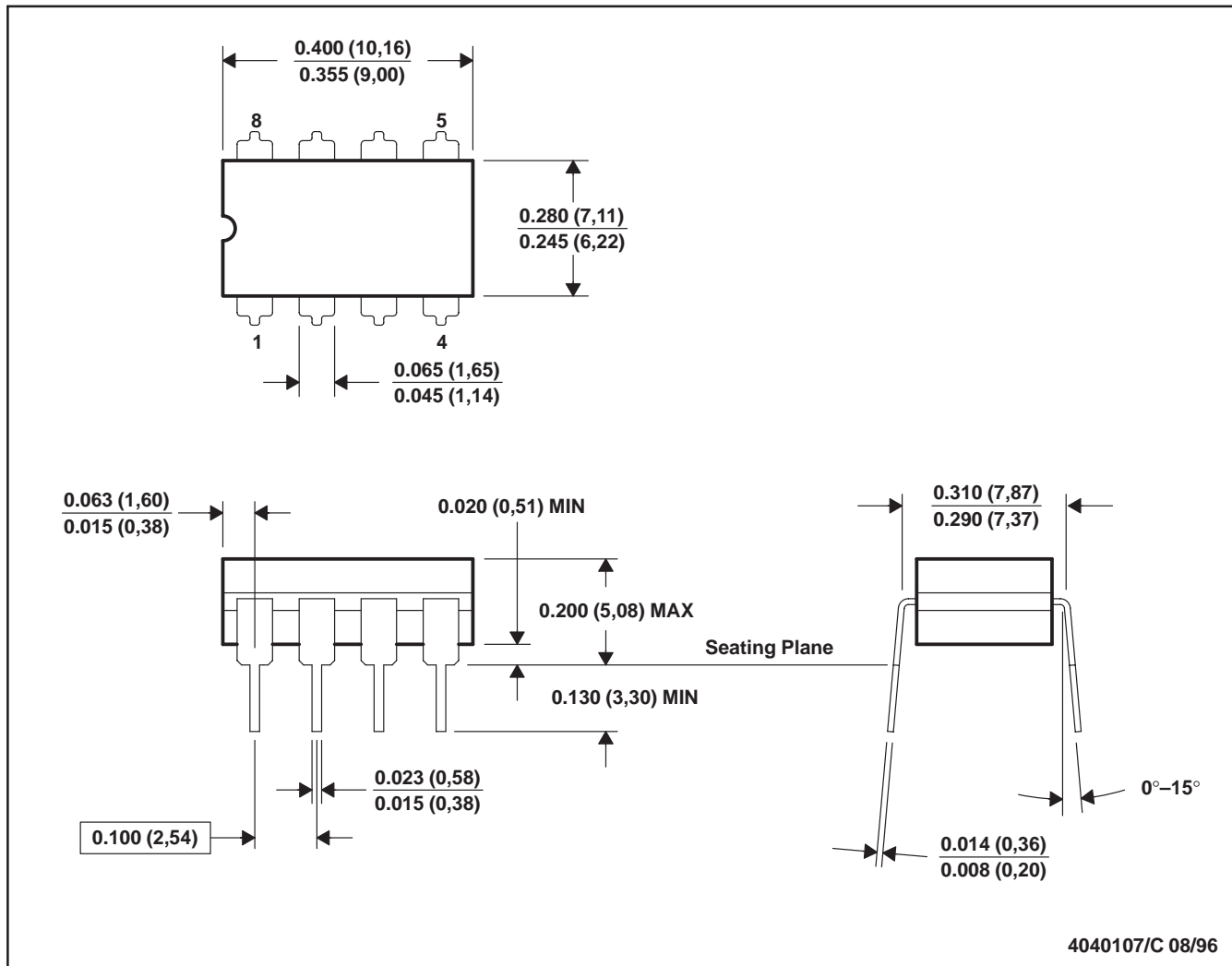

4040107/C 08/96

- NOTES: A. All linear dimensions are in inches (millimeters).
 B. This drawing is subject to change without notice.
 C. This package can be hermetically sealed with a ceramic lid using glass frit.
 D. Index point is provided on cap for terminal identification.
 E. Falls within MIL STD 1835 GDIP1-T8

J (R-GDIP-T**)
14 LEADS SHOWN

CERAMIC DUAL IN-LINE PACKAGE

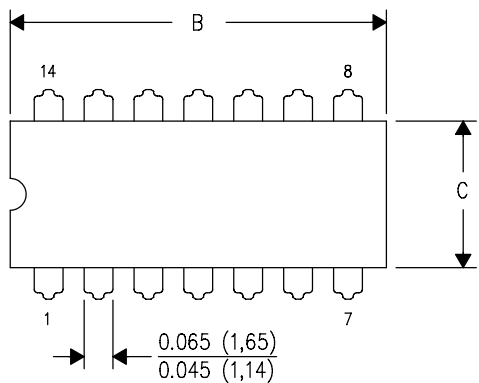

DIM \ PINS **	14	16	18	20
A	0.300 (7,62) BSC	0.300 (7,62) BSC	0.300 (7,62) BSC	0.300 (7,62) BSC
B MAX	0.785 (19,94)	.840 (21,34)	0.960 (24,38)	1.060 (26,92)
B MIN	—	—	—	—
C MAX	0.300 (7,62)	0.300 (7,62)	0.310 (7,87)	0.300 (7,62)
C MIN	0.245 (6,22)	0.245 (6,22)	0.220 (5,59)	0.245 (6,22)

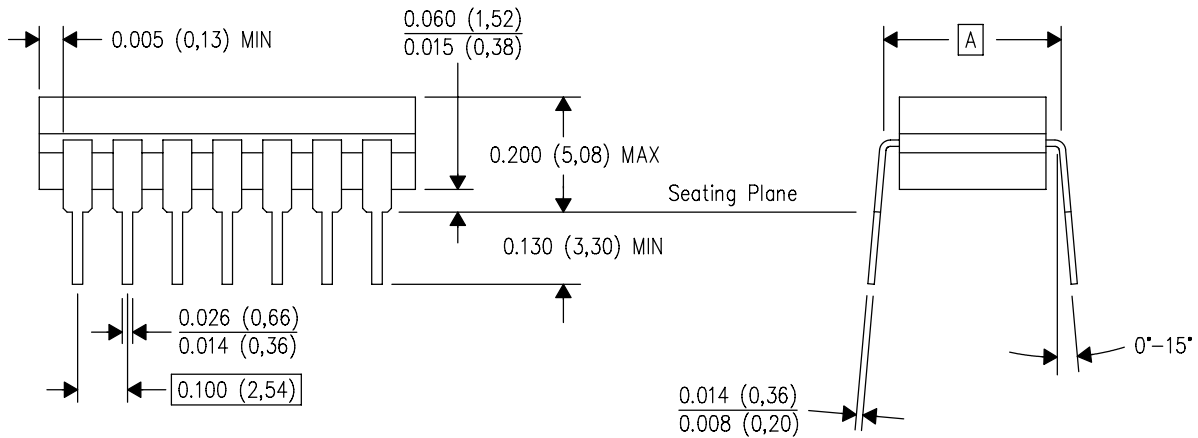

4040083/F 03/03

- NOTES:
- All linear dimensions are in inches (millimeters).
 - This drawing is subject to change without notice.
 - This package is hermetically sealed with a ceramic lid using glass frit.
 - Index point is provided on cap for terminal identification only on press ceramic glass frit seal only.
 - Falls within MIL STD 1835 GDIP1-T14, GDIP1-T16, GDIP1-T18 and GDIP1-T20.

U (S-GDFP-F10)

CERAMIC DUAL FLATPACK

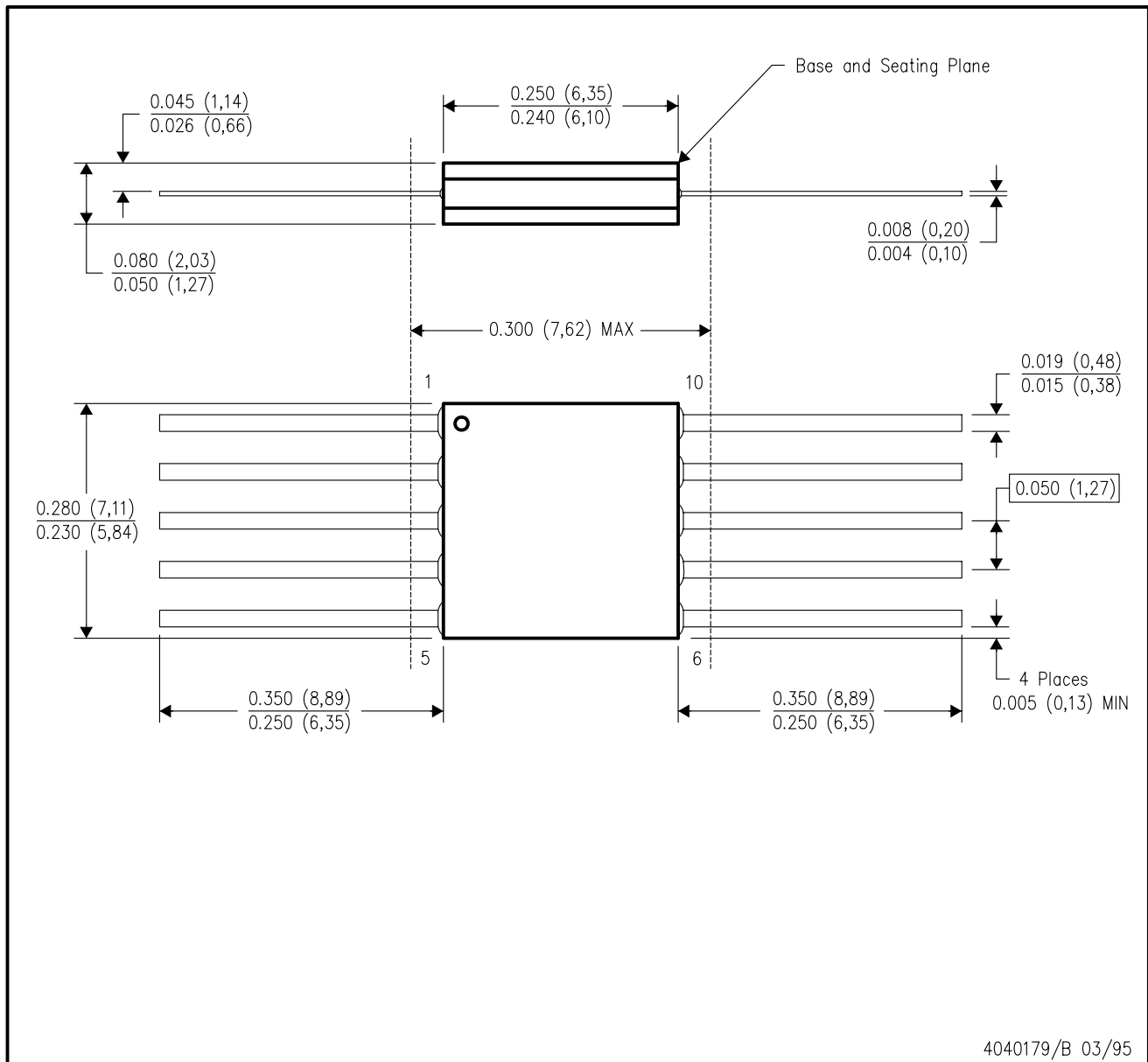

- NOTES:
- All linear dimensions are in inches (millimeters).
 - This drawing is subject to change without notice.
 - This package can be hermetically sealed with a ceramic lid using glass frit.
 - Index point is provided on cap for terminal identification only.
 - Falls within MIL STD 1835 GDFP1-F10 and JEDEC MO-092AA

W (R-GDFP-F14)

CERAMIC DUAL FLATPACK

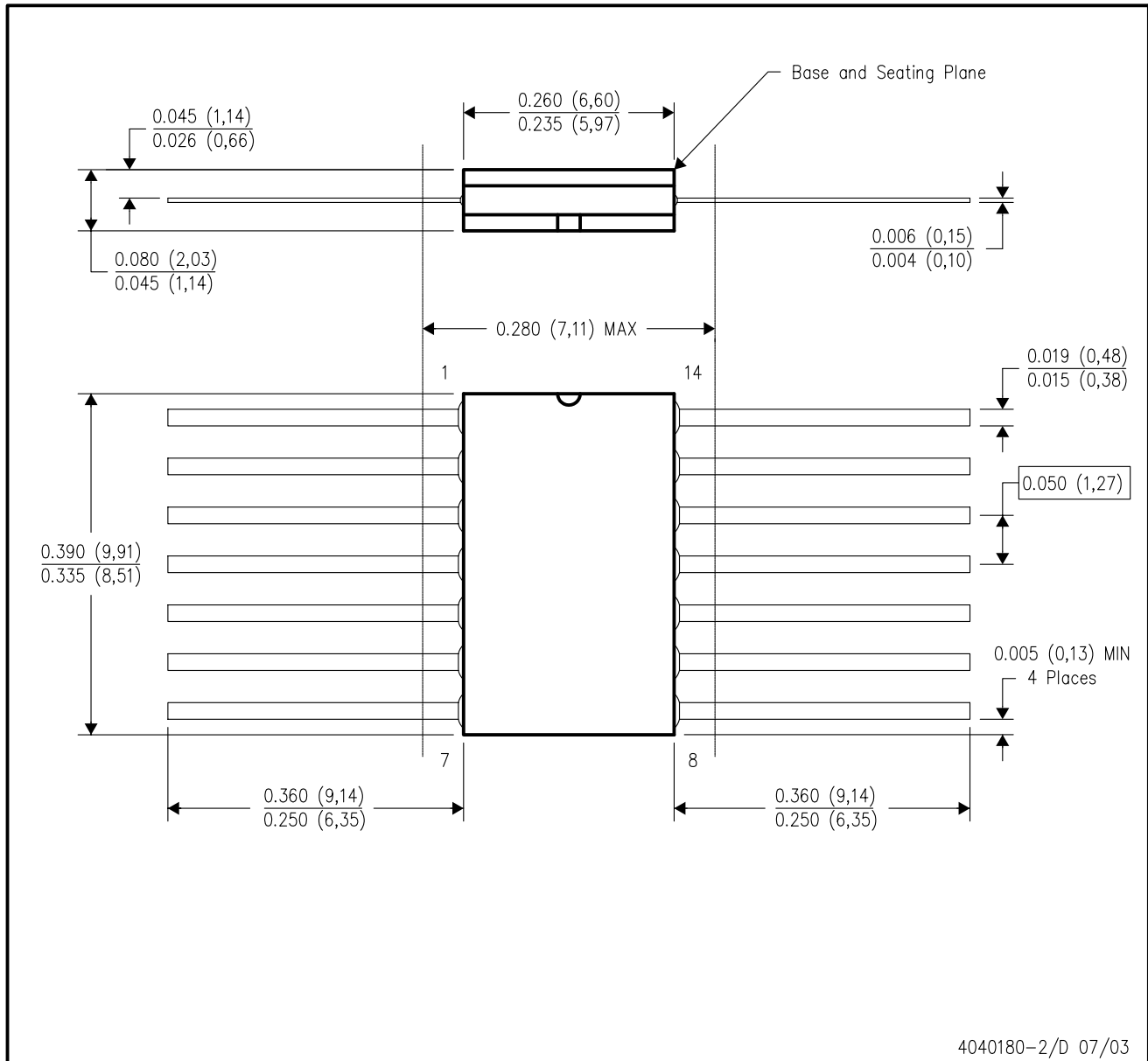

4040180-2/D 07/03

- NOTES:
- A. All linear dimensions are in inches (millimeters).
 - B. This drawing is subject to change without notice.
 - C. This package can be hermetically sealed with a ceramic lid using glass frit.
 - D. Index point is provided on cap for terminal identification only.
 - E. Falls within MIL STD 1835 GDFP1-F14 and JEDEC MO-092AB

FK (S-CQCC-N**)

LEADLESS CERAMIC CHIP CARRIER

28 TERMINAL SHOWN

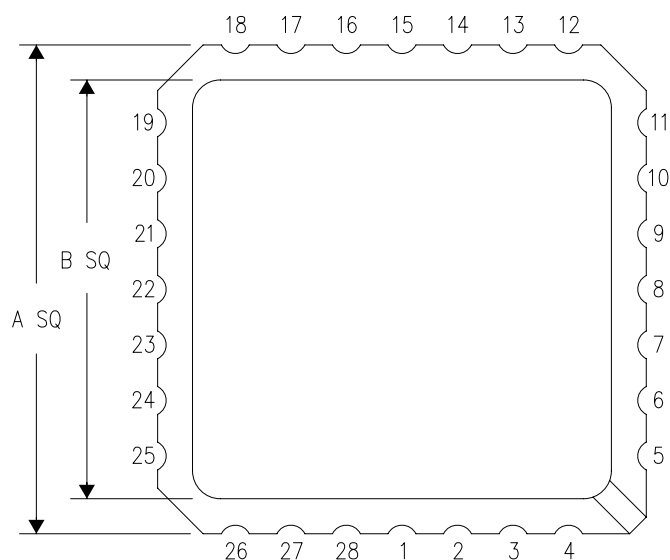

NO. OF TERMINALS **	A		B	
	MIN	MAX	MIN	MAX
20	0.342 (8,69)	0.358 (9,09)	0.307 (7,80)	0.358 (9,09)
28	0.442 (11,23)	0.458 (11,63)	0.406 (10,31)	0.458 (11,63)
44	0.640 (16,26)	0.660 (16,76)	0.495 (12,58)	0.560 (14,22)
52	0.740 (18,78)	0.761 (19,32)	0.495 (12,58)	0.560 (14,22)
68	0.938 (23,83)	0.962 (24,43)	0.850 (21,6)	0.858 (21,8)
84	1.141 (28,99)	1.165 (29,59)	1.047 (26,6)	1.063 (27,0)

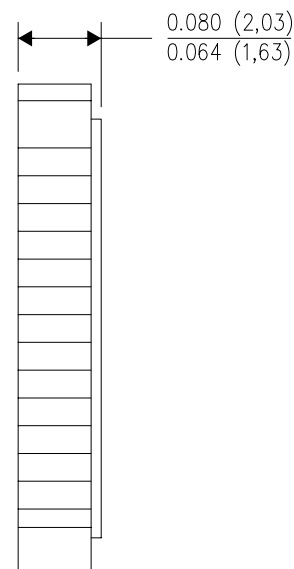
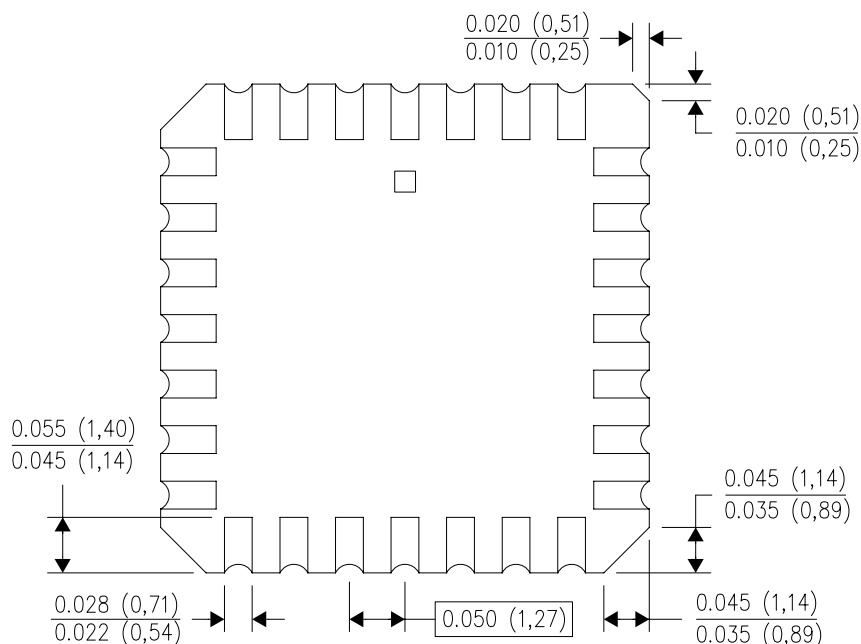

4040140/D 01/11

- NOTES:
- A. All linear dimensions are in inches (millimeters).
 - B. This drawing is subject to change without notice.
 - C. This package can be hermetically sealed with a metal lid.
 - D. Falls within JEDEC MS-004

P (R-PDIP-T8)

PLASTIC DUAL-IN-LINE PACKAGE

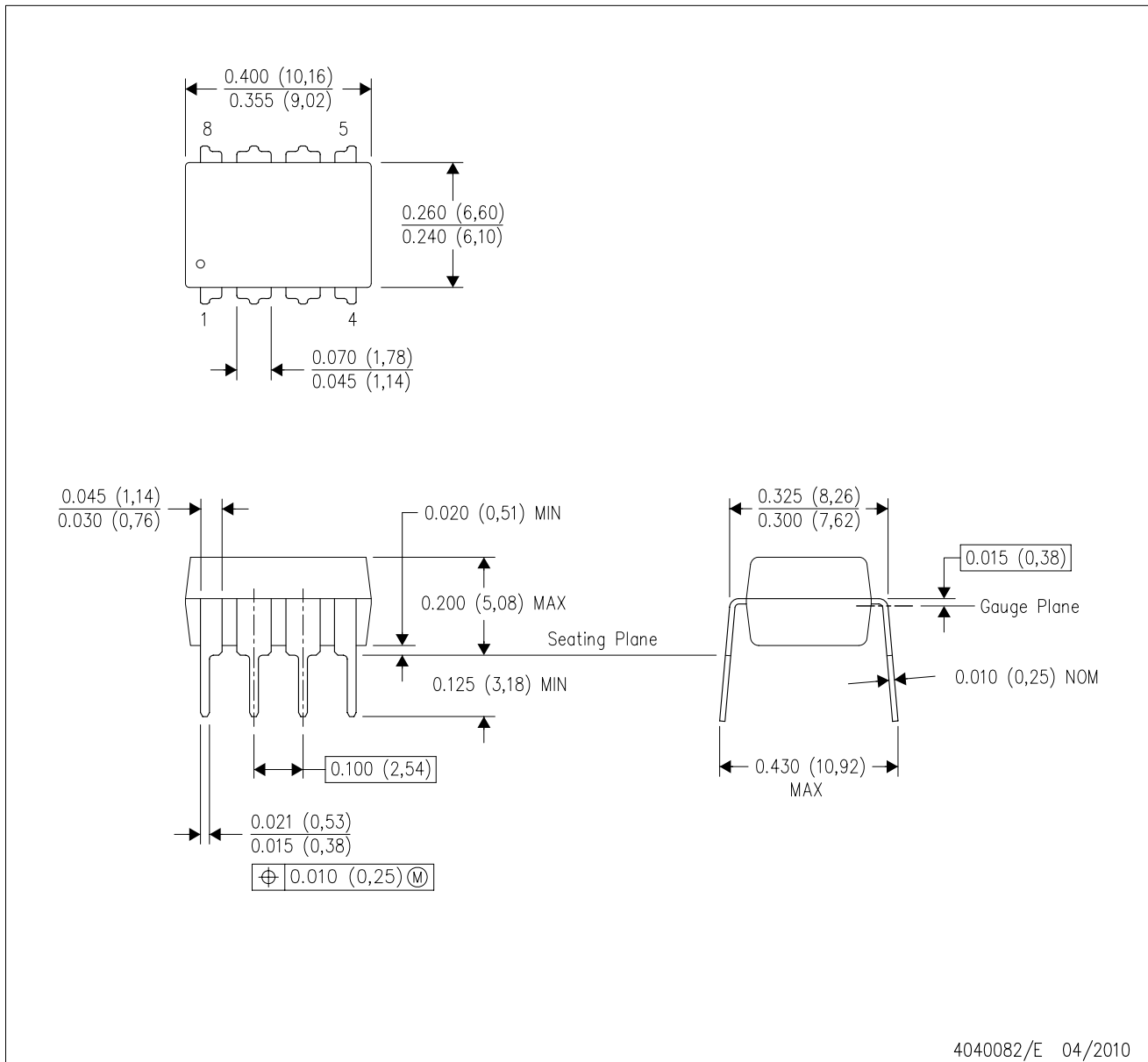



- NOTES:
- A. All linear dimensions are in inches (millimeters).
 - B. This drawing is subject to change without notice.
 - C. Falls within JEDEC MS-001 variation BA.

D (R-PDSO-G14)

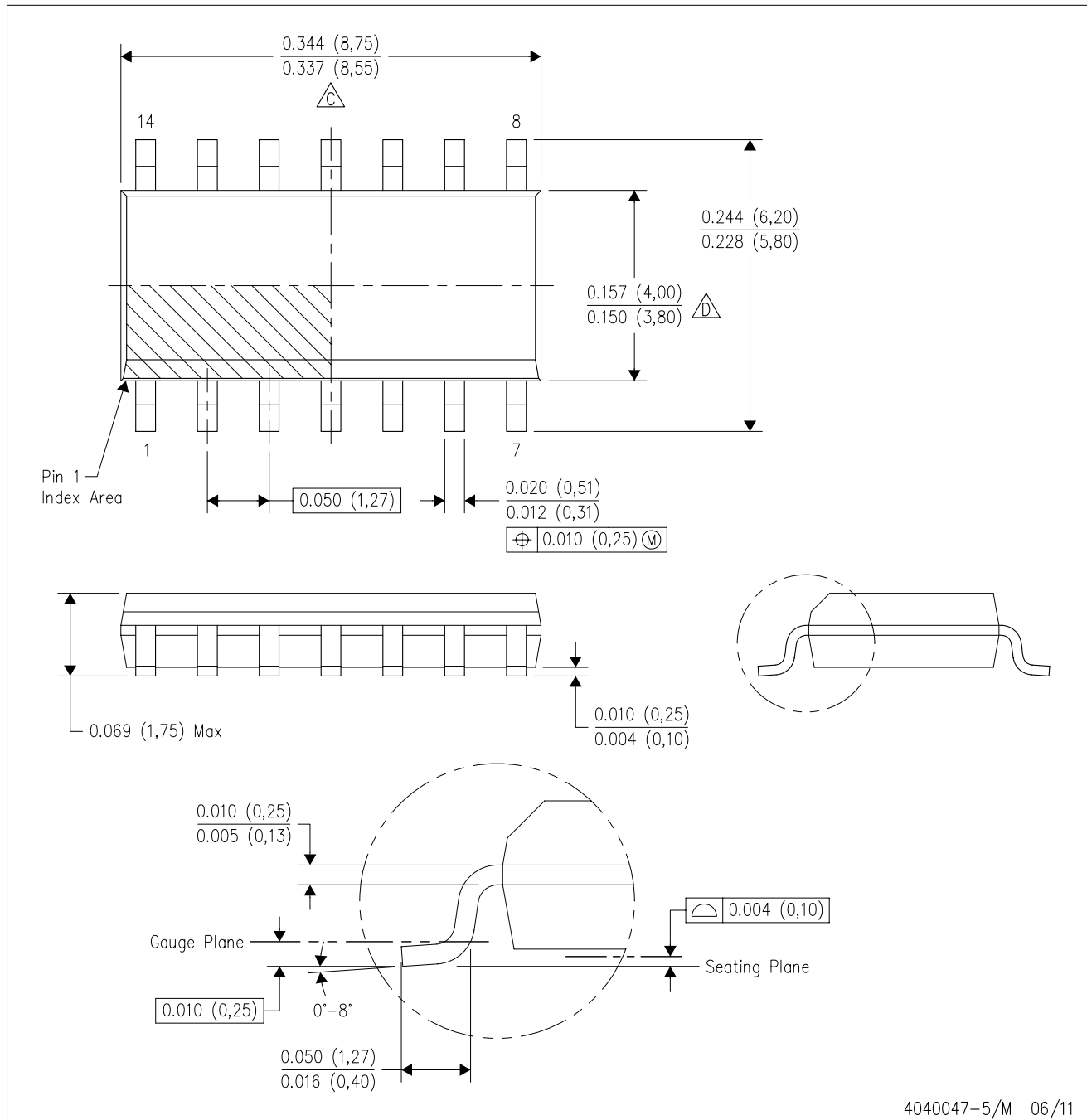
PLASTIC SMALL OUTLINE





- NOTES:
- A. All linear dimensions are in inches (millimeters).
 - B. This drawing is subject to change without notice.
 -  Body length does not include mold flash, protrusions, or gate burrs. Mold flash, protrusions, or gate burrs shall not exceed 0.006 (0,15) each side.
 -  Body width does not include interlead flash. Interlead flash shall not exceed 0.017 (0,43) each side.
 - E. Reference JEDEC MS-012 variation AB.

PW (R-PDSO-G14)

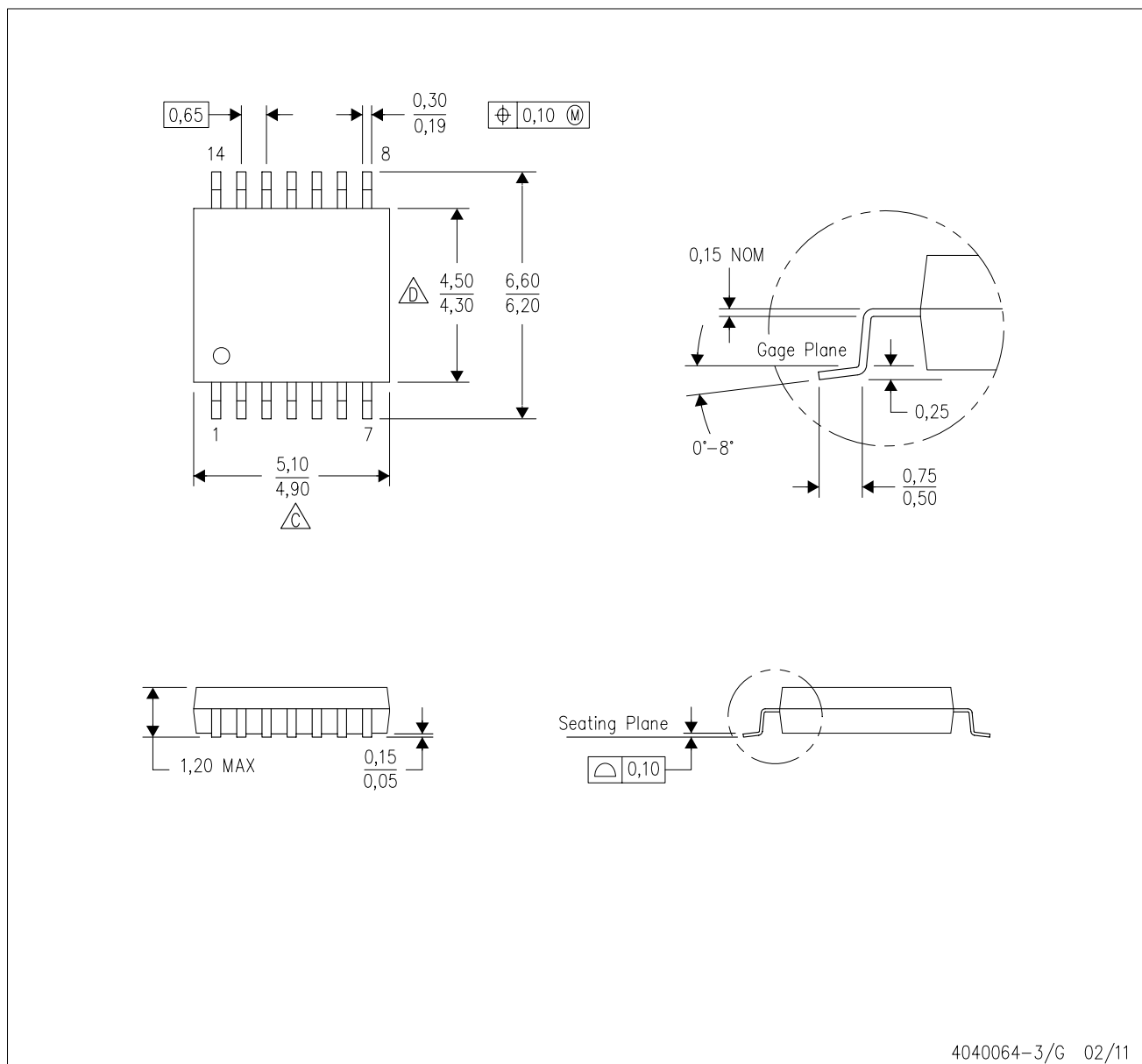
PLASTIC SMALL OUTLINE



4040064-3/G 02/11

- NOTES:
- A. All linear dimensions are in millimeters. Dimensioning and tolerancing per ASME Y14.5M-1994.
 - B. This drawing is subject to change without notice.
 -  C. Body length does not include mold flash, protrusions, or gate burrs. Mold flash, protrusions, or gate burrs shall not exceed 0,15 each side.
 -  D. Body width does not include interlead flash. Interlead flash shall not exceed 0,25 each side.
 - E. Falls within JEDEC MO-153

PW (R-PDSO-G14)

PLASTIC SMALL OUTLINE

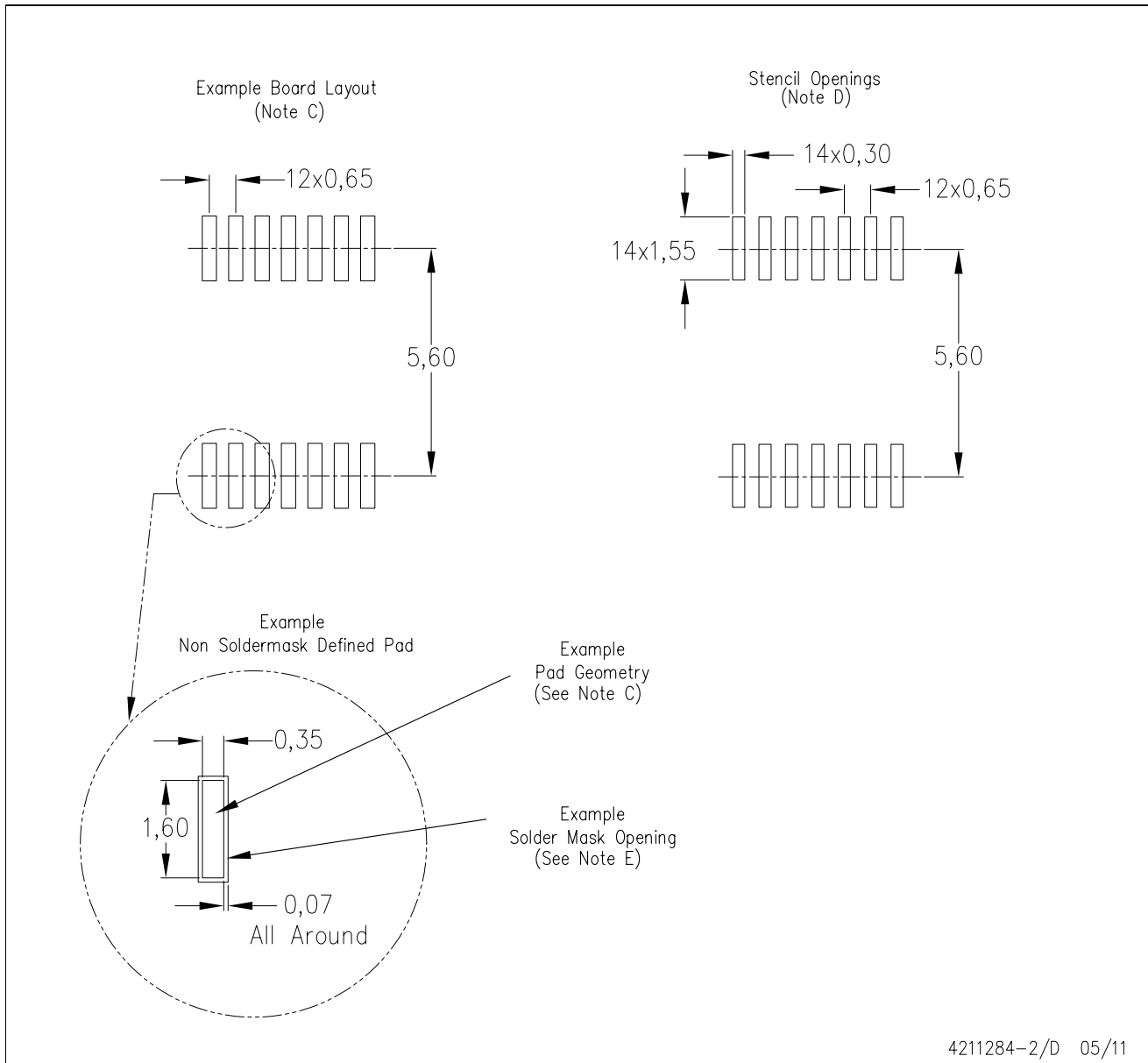

- NOTES:
- A. All linear dimensions are in millimeters.
 - B. This drawing is subject to change without notice.
 - C. Publication IPC-7351 is recommended for alternate designs.
 - D. Laser cutting apertures with trapezoidal walls and also rounding corners will offer better paste release. Customers should contact their board assembly site for stencil design recommendations. Refer to IPC-7525 for other stencil recommendations.
 - E. Customers should contact their board fabrication site for solder mask tolerances between and around signal pads.

PW (R-PDSO-G28)

PLASTIC SMALL OUTLINE

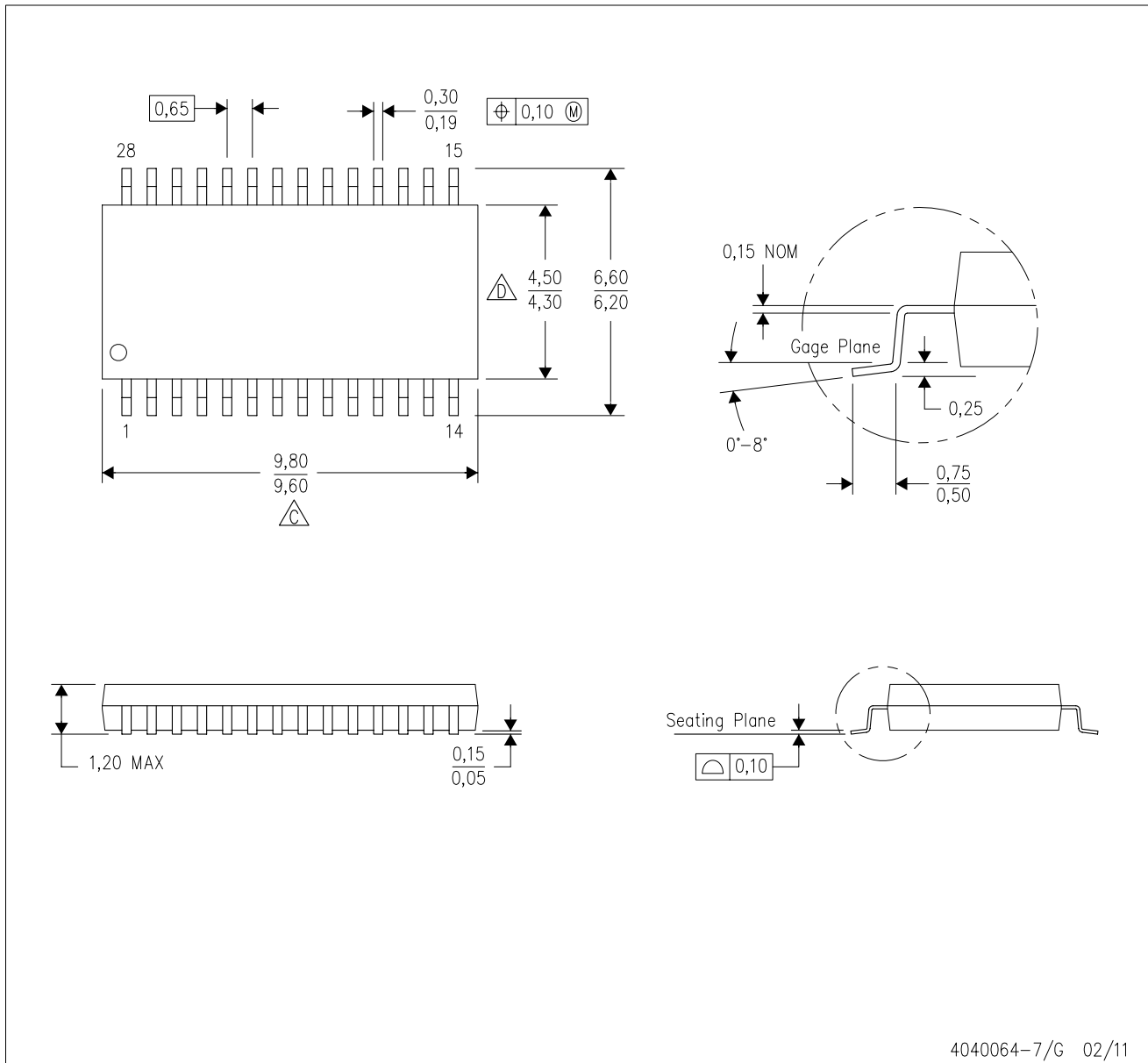

4040064-7/G 02/11

- NOTES:
- A. All linear dimensions are in millimeters. Dimensioning and tolerancing per ASME Y14.5M-1994.
 - B. This drawing is subject to change without notice.
 - C. Body length does not include mold flash, protrusions, or gate burrs. Mold flash, protrusions, or gate burrs shall not exceed 0,15 each side.
 - D. Body width does not include interlead flash. Interlead flash shall not exceed 0,25 each side.
 - E. Falls within JEDEC MO-153

D (R-PDSO-G8)

PLASTIC SMALL OUTLINE

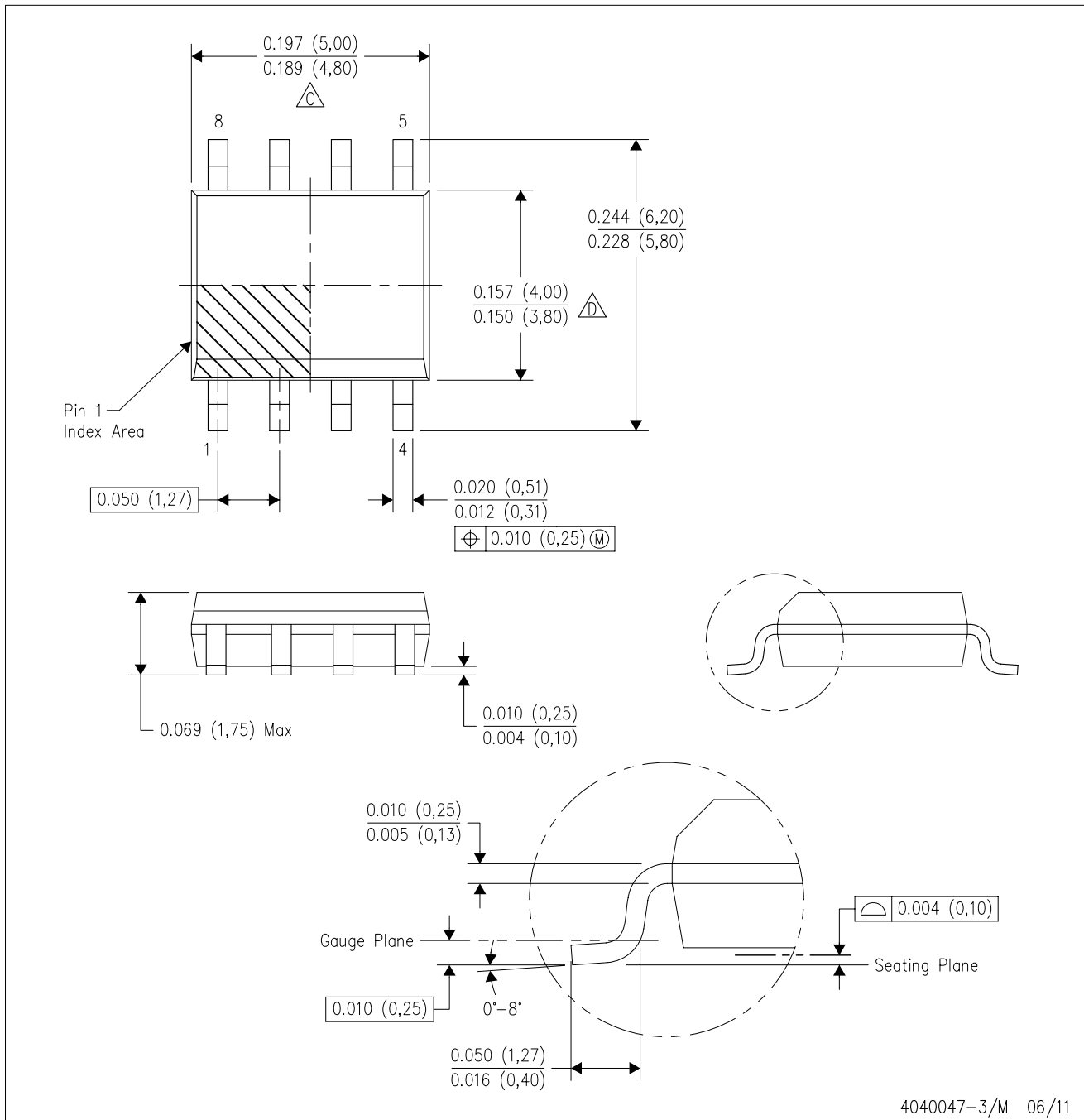

NOTES: A. All linear dimensions are in inches (millimeters).
 B. This drawing is subject to change without notice.
 C. Body length does not include mold flash, protrusions, or gate burrs. Mold flash, protrusions, or gate burrs shall not exceed 0.006 (0,15) each side.
 D. Body width does not include interlead flash. Interlead flash shall not exceed 0.017 (0,43) each side.
 E. Reference JEDEC MS-012 variation AA.

D (R-PDSO-G8)

PLASTIC SMALL OUTLINE

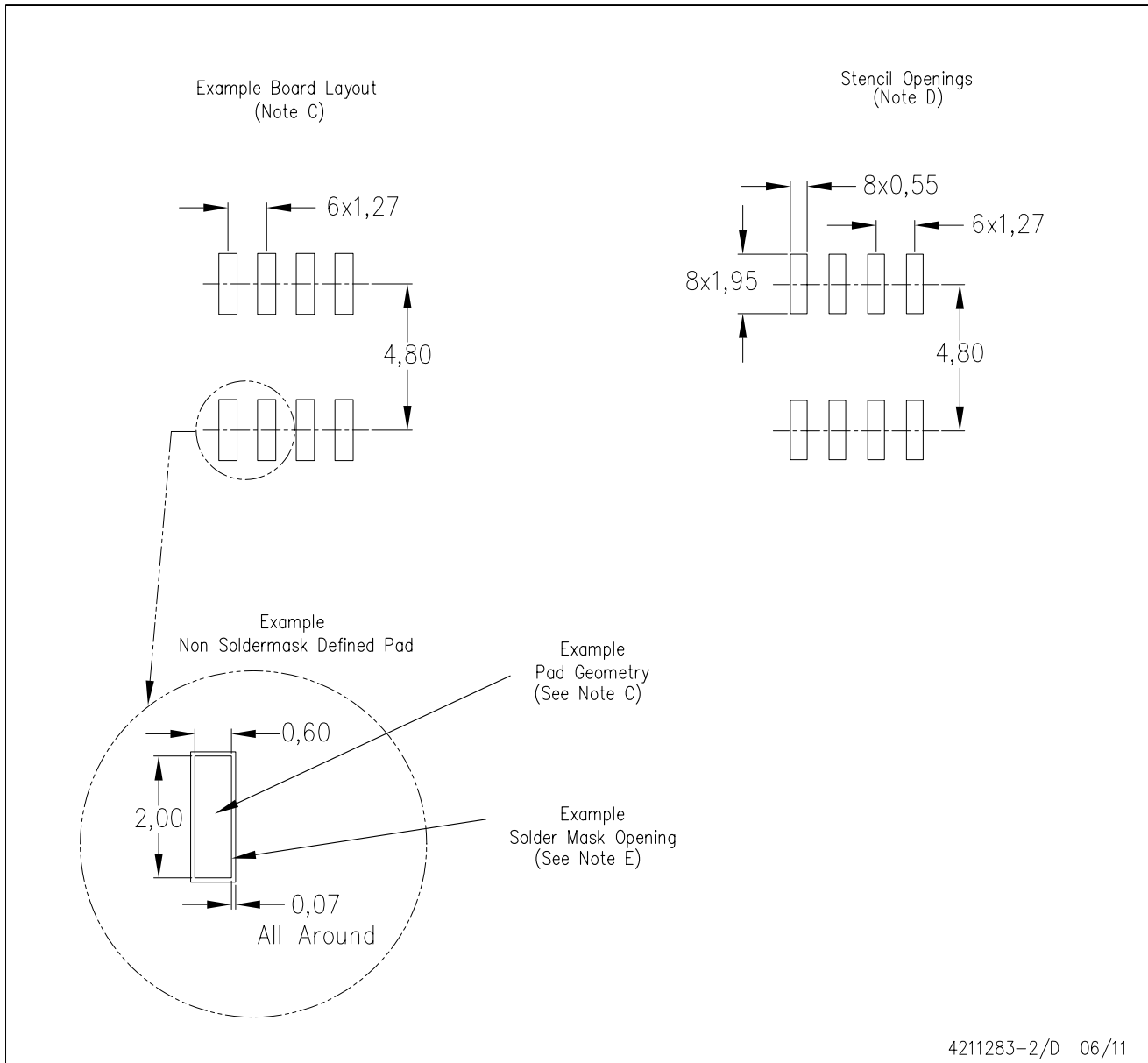

- NOTES:
- All linear dimensions are in millimeters.
 - This drawing is subject to change without notice.
 - Publication IPC-7351 is recommended for alternate designs.
 - Laser cutting apertures with trapezoidal walls and also rounding corners will offer better paste release. Customers should contact their board assembly site for stencil design recommendations. Refer to IPC-7525 for other stencil recommendations.
 - Customers should contact their board fabrication site for solder mask tolerances between and around signal pads.

PW (R-PDSO-G8)

PLASTIC SMALL OUTLINE

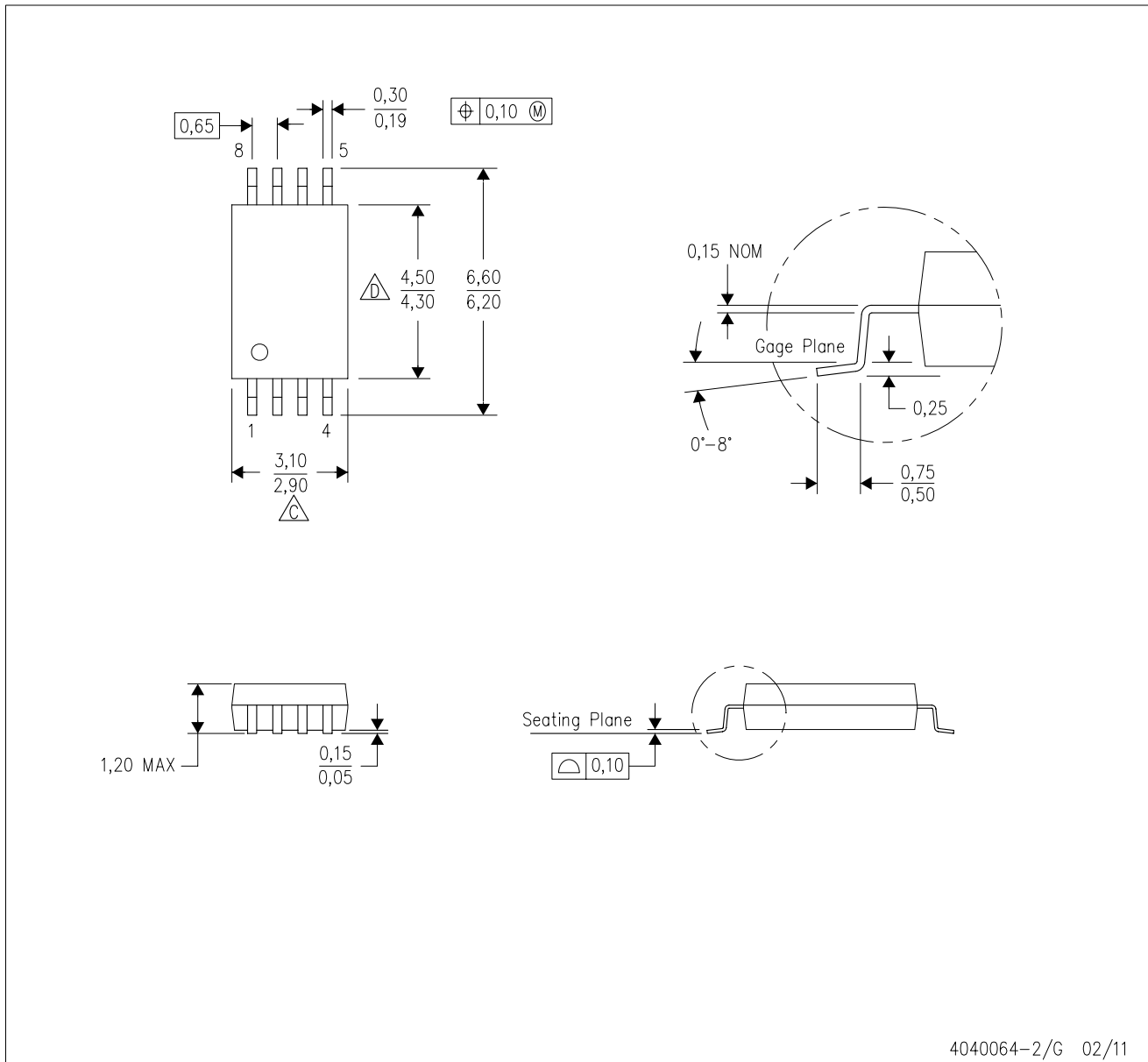

- NOTES:
- A. All linear dimensions are in millimeters. Dimensioning and tolerancing per ASME Y14.5M-1994.
 - B. This drawing is subject to change without notice.
 - C. Body length does not include mold flash, protrusions, or gate burrs. Mold flash, protrusions, or gate burrs shall not exceed 0,15 each side.
 - D. Body width does not include interlead flash. Interlead flash shall not exceed 0,25 each side.
 - E. Falls within JEDEC MO-153

IMPORTANT NOTICE

Texas Instruments Incorporated and its subsidiaries (TI) reserve the right to make corrections, modifications, enhancements, improvements, and other changes to its products and services at any time and to discontinue any product or service without notice. Customers should obtain the latest relevant information before placing orders and should verify that such information is current and complete. All products are sold subject to TI's terms and conditions of sale supplied at the time of order acknowledgment.

TI warrants performance of its hardware products to the specifications applicable at the time of sale in accordance with TI's standard warranty. Testing and other quality control techniques are used to the extent TI deems necessary to support this warranty. Except where mandated by government requirements, testing of all parameters of each product is not necessarily performed.

TI assumes no liability for applications assistance or customer product design. Customers are responsible for their products and applications using TI components. To minimize the risks associated with customer products and applications, customers should provide adequate design and operating safeguards.

TI does not warrant or represent that any license, either express or implied, is granted under any TI patent right, copyright, mask work right, or other TI intellectual property right relating to any combination, machine, or process in which TI products or services are used. Information published by TI regarding third-party products or services does not constitute a license from TI to use such products or services or a warranty or endorsement thereof. Use of such information may require a license from a third party under the patents or other intellectual property of the third party, or a license from TI under the patents or other intellectual property of TI.

Reproduction of TI information in TI data books or data sheets is permissible only if reproduction is without alteration and is accompanied by all associated warranties, conditions, limitations, and notices. Reproduction of this information with alteration is an unfair and deceptive business practice. TI is not responsible or liable for such altered documentation. Information of third parties may be subject to additional restrictions.

Resale of TI products or services with statements different from or beyond the parameters stated by TI for that product or service voids all express and any implied warranties for the associated TI product or service and is an unfair and deceptive business practice. TI is not responsible or liable for any such statements.

TI products are not authorized for use in safety-critical applications (such as life support) where a failure of the TI product would reasonably be expected to cause severe personal injury or death, unless officers of the parties have executed an agreement specifically governing such use. Buyers represent that they have all necessary expertise in the safety and regulatory ramifications of their applications, and acknowledge and agree that they are solely responsible for all legal, regulatory and safety-related requirements concerning their products and any use of TI products in such safety-critical applications, notwithstanding any applications-related information or support that may be provided by TI. Further, Buyers must fully indemnify TI and its representatives against any damages arising out of the use of TI products in such safety-critical applications.

TI products are neither designed nor intended for use in military/aerospace applications or environments unless the TI products are specifically designated by TI as military-grade or "enhanced plastic." Only products designated by TI as military-grade meet military specifications. Buyers acknowledge and agree that any such use of TI products which TI has not designated as military-grade is solely at the Buyer's risk, and that they are solely responsible for compliance with all legal and regulatory requirements in connection with such use.

TI products are neither designed nor intended for use in automotive applications or environments unless the specific TI products are designated by TI as compliant with ISO/TS 16949 requirements. Buyers acknowledge and agree that, if they use any non-designated products in automotive applications, TI will not be responsible for any failure to meet such requirements.

Following are URLs where you can obtain information on other Texas Instruments products and application solutions:

Products

Audio	www.ti.com/audio
Amplifiers	amplifier.ti.com
Data Converters	dataconverter.ti.com
DLP® Products	www.dlp.com
DSP	dsp.ti.com
Clocks and Timers	www.ti.com/clocks
Interface	interface.ti.com
Logic	logic.ti.com
Power Mgmt	power.ti.com
Microcontrollers	microcontroller.ti.com
RFID	www.ti-rfid.com
RF/IF and ZigBee® Solutions	www.ti.com/lprf

Applications

Communications and Telecom	www.ti.com/communications
Computers and Peripherals	www.ti.com/computers
Consumer Electronics	www.ti.com/consumer-apps
Energy and Lighting	www.ti.com/energy
Industrial	www.ti.com/industrial
Medical	www.ti.com/medical
Security	www.ti.com/security
Space, Avionics and Defense	www.ti.com/space-avionics-defense
Transportation and Automotive	www.ti.com/automotive
Video and Imaging	www.ti.com/video
Wireless	www.ti.com/wireless-apps

TI E2E Community Home Page

e2e.ti.com

Mailing Address: Texas Instruments, Post Office Box 655303, Dallas, Texas 75265
Copyright © 2011, Texas Instruments Incorporated

www.BDTIC.com/TI