

# TLV277x-EP, TLV277xA-EP

## FAMILY OF 2.7-V HIGH-SLEW-RATE RAIL-TO-RAIL OUTPUT OPERATIONAL AMPLIFIERS WITH SHUTDOWN

SGLS317A – OCTOBER 2005 – REVISED SEPTEMBER 2007

- **Controlled Baseline**
  - One Assembly/Test Site, One Fabrication Site
- **Extended Temperature Performance of –55°C to 125°C**
- **Enhanced Diminishing Manufacturing Sources (DMS) Support**
- **Enhanced Product-Change Notification**
- **Qualification Pedigree<sup>(1)</sup>**
- **ESD Protection Exceeds 2000 V Per MIL-STD-883, Method 3015; Exceeds 200 V Using Machine Model (C = 200 pF, R = 0)**
- **High Slew Rate . . . 10.5 V/μs Typ**
- **High-Gain Bandwidth . . . 5.1 MHz Typ**
- **Supply Voltage Range 2.5 V to 5.5 V**
- **Rail-to-Rail Output**
- **360 μV Input Offset Voltage**
- **Low Distortion Driving 600-Ω 0.005% THD+N**
- **1 mA Supply Current (Per Channel)**
- **17 nV/√Hz Input Noise Voltage**
- **2 pA Input Bias Current**
- **Characterized From T<sub>A</sub> = –55°C to 125°C**
- **Micropower Shutdown Mode . . . I<sub>DD</sub> < 1 μA**

<sup>†</sup> Component qualification in accordance with JEDEC and industry standards to ensure reliable operation over an extended temperature range. This includes, but is not limited to, Highly Accelerated Stress Test (HAST) or biased 85/85, temperature cycle, autoclave or unbiased HAST, electromigration, bond intermetallic life, and mold compound life. Such qualification testing should not be viewed as justifying use of this component beyond specified performance and environmental limits.

### description

The TLV277x CMOS operational amplifier family combines high slew rate and bandwidth, rail-to-rail output swing, high output drive, and excellent dc precision. The device provides 10.5 V/μs of slew rate and 5.1 MHz of bandwidth while only consuming 1 mA of supply current per channel. This ac performance is much higher than current competitive CMOS amplifiers. The rail-to-rail output swing and high output drive make these devices a good choice for driving the analog input or reference of analog-to-digital converters (ADCs). These devices also have low distortion while driving a 600-Ω load for use in telecom systems.

These amplifiers have a 360-μV input offset voltage, a 17 nV/√Hz input noise voltage, and a 2-pA input bias current for measurement, medical, and industrial applications. The TLV277x family is also specified across an extended temperature range (–55°C to 125°C), making it useful for military and avionics systems.

These devices operate from a 2.5-V to 5.5-V single supply voltage and are characterized at 2.7 V and 5 V. The single-supply operation and low power consumption make these devices a good solution for portable applications. The following table lists the packages available.

FAMILY PACKAGE TABLE

DEVICE	NUMBER OF CHANNELS	PACKAGE TYPES		SHUTDOWN	UNIVERSAL EVM BOARD
		SOIC	TSSOP		
TLV2770	1	8	—	Yes	See the EVM Selection Guide (SLOU060)
TLV2771	1	8	—	—	
TLV2772	2	8	8	—	
TLV2773	2	14	—	Yes	
TLV2774	4	14	14	—	
TLV2775	4	16	16	Yes	



Please be aware that an important notice concerning availability, standard warranty, and use in critical applications of Texas Instruments semiconductor products and disclaimers thereto appears at the end of this data sheet.

UNLESS OTHERWISE NOTED this document contains PRODUCTION DATA information current as of publication date. Products conform to specifications per the terms of Texas Instruments standard warranty. Production processing does not necessarily include testing of all parameters.

Copyright © 2007 Texas Instruments Incorporated

# TLV277x-EP, TLV277xA-EP FAMILY OF 2.7-V HIGH-SLEW-RATE RAIL-TO-RAIL OUTPUT OPERATIONAL AMPLIFIERS WITH SHUTDOWN

SGLS317A – OCTOBER 2005 – REVISED SEPTEMBER 2007

## SELECTION OF SINGLE-SUPPLY OPERATIONAL AMPLIFIER PRODUCTS†

DEVICE	V <sub>DD</sub> (V)	BW (MHz)	SLEW RATE (V/μs)	I <sub>DD</sub> (per channel) (μA)	RAIL-TO-RAIL
TLV277X	2.5 to 6	5.1	10.5	1000	O
TLV247X	2.7 to 6	2.8	1.5	600	I/O
TLV245X	2.7 to 6	0.22	0.11	23	I/O
TLV246X	2.7 to 6	6.4	1.6	550	I/O

† All specifications measured at 5 V.

## ORDERING INFORMATION†

T <sub>A</sub>	V <sub>IO</sub> MAX AT 25°C (mV)	PACKAGE‡		ORDERABLE PART NUMBER	TOP SIDE MARKING
-55°C to 125°C	2.5	SOIC (D)	Tape and reel	TLV2770MDREP§	
	1.6	SOIC (D)	Tape and reel	TLV2770AMDREP§	
	2.5	SOIC (D)	Tape and reel	TLV2771MDREP§	
	1.6	SOIC (D)	Tape and reel	TLV2771AMDREP§	
	2.5	SOIC (D)	Tape and reel	TLV2772MDREP§	
		TSSOP (PW)	Tape and reel	TLV2772MPWREP§	
	1.6	SOIC (D)	Tape and reel	TLV2772AMDREP	2772AE
		TSSOP (PW)	Tape and reel	TLV2772AMPWREP§	
	2.5	SOIC (D)	Tape and reel	TLV2773MDREP§	
	1.6	SOIC (D)	Tape and reel	TLV2773AMDREP§	
	2.7	SOIC (D)	Tape and reel	TLV2774MDREP	2774EP
		TSSOP (PW)	Tape and reel	TLV2774MPWREP§	
	2.1	SOIC (D)	Tape and reel	TLV2774AMDREP	2774AEP
		TSSOP (PW)	Tape and reel	TLV2774AMPWREP§	
	2.7	SOIC (D)	Tape and reel	TLV2775MDREP§	
		TSSOP (PW)	Tape and reel	TLV2775MPWREP§	
	2.1	SOIC (D)	Tape and reel	TLV2775AMDREP§	
		TSSOP (PW)	Tape and reel	TLV2775AMPWREP§	

† For the most current package and ordering information, see the Package Option Addendum at the end of this document, or see the TI website at [www.ti.com](http://www.ti.com).

‡ Package drawings, standard packing quantities, thermal data, symbolization, and PCB design guidelines are available at [www.ti.com/packaging](http://www.ti.com/packaging).

§ Product Preview

# TLV277x-EP, TLV277xA-EP FAMILY OF 2.7-V HIGH-SLEW-RATE RAIL-TO-RAIL OUTPUT OPERATIONAL AMPLIFIERS WITH SHUTDOWN

SGLS317A – OCTOBER 2005 – REVISED SEPTEMBER 2007

## TLV277x PACKAGE PINOUTS

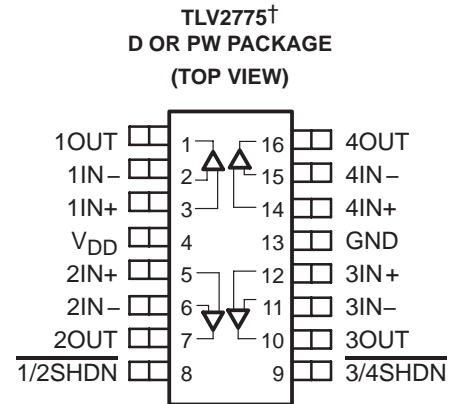
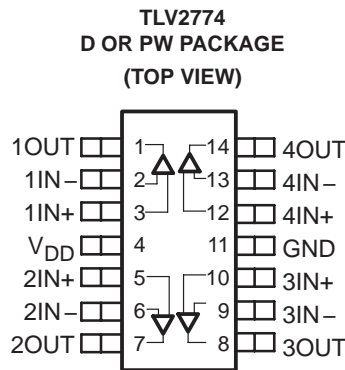
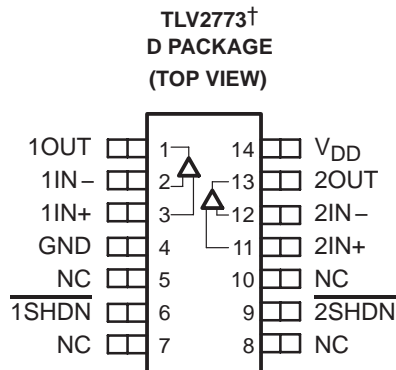
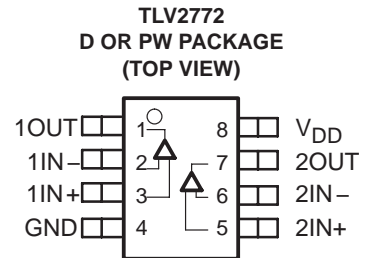
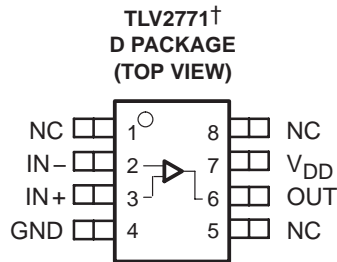
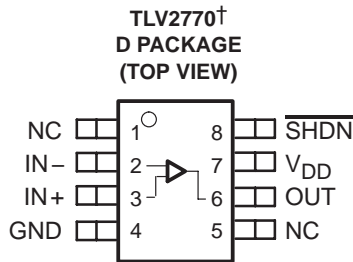

NC – No internal connection

† This device is in the Product Preview stage of development. Please contact your local TI sales office for availability.

# TLV277x-EP, TLV277xA-EP FAMILY OF 2.7-V HIGH-SLEW-RATE RAIL-TO-RAIL OUTPUT OPERATIONAL AMPLIFIERS WITH SHUTDOWN

SGLS317A – OCTOBER 2005 – REVISED SEPTEMBER 2007

## absolute maximum ratings over operating free-air temperature range (unless otherwise noted)†

Supply voltage, $V_{DD}$ (see Note 1)	7 V
Differential input voltage, $V_{ID}$ (see Note 2)	$\pm V_{DD}$
Input voltage range, $V_I$ (any input, see Note 1)	-0.3 V to $V_{DD}$
Input current, $I_I$ (any input)	$\pm 4$ mA
Output current, $I_O$	$\pm 50$ mA
Total current into $V_{DD+}$	$\pm 50$ mA
Total current out of GND	$\pm 50$ mA
Duration of short-circuit current (at or below) 25°C (see Note 3)	unlimited
Continuous total power dissipation	See Dissipation Rating Table
Operating free-air temperature range, $T_A$ : M suffix	-55°C to 125°C
Storage temperature range, $T_{stg}$	-65°C to 150°C
Lead temperature 1,6 mm (1/16 inch) from case for 10 seconds	260°C

† Stresses beyond those listed under “absolute maximum ratings” may cause permanent damage to the device. These are stress ratings only, and functional operation of the device at these or any other conditions beyond those indicated under “recommended operating conditions” is not implied. Exposure to absolute-maximum-rated conditions for extended periods may affect device reliability.

- NOTES:
1. All voltage values, except differential voltages, are with respect to GND.
  2. Differential voltages are at the noninverting input with respect to the inverting input. Excessive current flows when input is brought below GND - 0.3 V.
  3. The output may be shorted to either supply. Temperature and/or supply voltages must be limited to ensure that the maximum dissipation rating is not exceeded.

DISSIPATION RATING TABLE

PACKAGE	$\theta_{JC}$ (°C/W)		$\theta_{JA}$ (°C/W, 0 AIR FLOW)	
	HIGH K	LOW K	HIGH K	LOW K
D(8)	39.4	42.4	97.1	165.5
D(14)	51.5	53.7	86.2	133.5
D(16)	36.9	38.4	73.1	111.6
PW(8)	65.1	69.4	149.4	230.5
PW(14)	45.8	46.6	111.7	131.4
PW(16)	33.6	35	108.4	147.0

NOTE 4: Thermal resistances are not production tested and are for informational purposes only.

## recommended operating conditions

	M SUFFIX		UNIT
	MIN	MAX	
Supply voltage, $V_{DD}$	2.5	6	V
Input voltage range, $V_I$	GND	$V_{DD+} - 1.3$	V
Common-mode input voltage, $V_{IC}$	GND	$V_{DD+} - 1.3$	V
Operating free-air temperature, $T_A$	-55	125	°C

TLV277x-EP, TLV277xA-EP  
FAMILY OF 2.7-V HIGH-SLEW-RATE RAIL-TO-RAIL OUTPUT  
OPERATIONAL AMPLIFIERS WITH SHUTDOWN

SGLS317A – OCTOBER 2005 – REVISED SEPTEMBER 2007

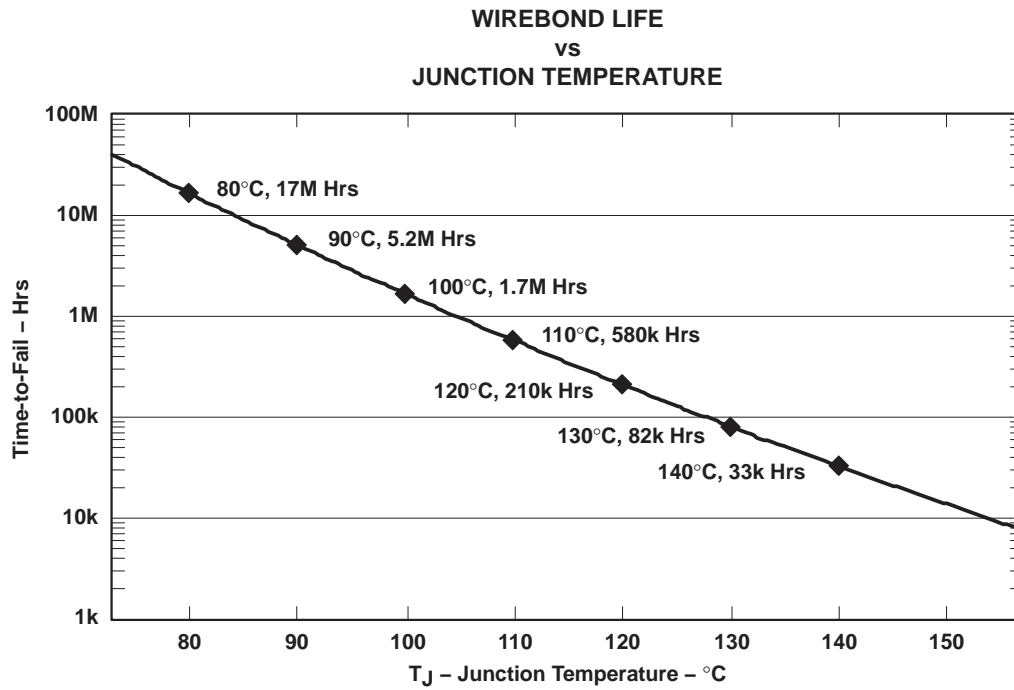

Figure 1. Wirebond Life Estimation

# TLV277x-EP, TLV277xA-EP FAMILY OF 2.7-V HIGH-SLEW-RATE RAIL-TO-RAIL OUTPUT OPERATIONAL AMPLIFIERS WITH SHUTDOWN

SGLS317A – OCTOBER 2005 – REVISED SEPTEMBER 2007

electrical characteristics at specified free-air temperature,  $V_{DD} = 2.7\text{ V}$  (unless otherwise noted)

PARAMETER	TEST CONDITIONS		$T_A$ †	TLV277xM			TLV277xAM			UNIT
				MIN	TYP	MAX	MIN	TYP	MAX	
$V_{IO}$ Input offset voltage	$V_{DD} = \pm 1.35\text{ V}$ , $V_{IC} = 0$ , $V_O = 0$ , $R_S = 50\ \Omega$	TLV2770/1/2/3	25°C	0.44	2.5		0.44	1.6	mV	
			Full range			2.7		1.9		
		TLV2774/5	25°C		0.8	2.7		0.8		2.1
			Full range			3.0				2.4
$\alpha_{VIO}$ Temperature coefficient of input offset voltage	$V_{DD} = \pm 1.35\text{ V}$ , $V_{IC} = 0$ , $V_O = 0$ , $R_S = 50\ \Omega$		25°C to 125°C		2		2		$\mu\text{V}/^\circ\text{C}$	
$I_{IO}$ Input offset current	$V_{DD} = \pm 1.35\text{ V}$ , $V_{IC} = 0$ , $V_O = 0$ , $R_S = 50\ \Omega$	TLV2770/1/2/3	25°C		1	60		1	60	pA
			Full range			125			125	
		TLV2774/5	Full range			200			200	
$I_{IB}$ Input bias current	$V_{DD} = \pm 1.35\text{ V}$ , $V_{IC} = 0$ , $V_O = 0$ , $R_S = 50\ \Omega$	TLV2770/1/2/3	25°C		2	60		2	60	pA
			Full range			350			350	
		TLV2774/5	Full range			500			500	
$V_{ICR}$ Common-mode input voltage range	CMRR > 60 dB, $R_S = 50\ \Omega$		25°C	0 to 1.4	-0.3 to 1.7		0 to 1.4	-0.3 to 1.7	V	
			Full range	0 to 1.4	-0.3 to 1.7		0 to 1.4	-0.3 to 1.7		
$V_{OH}$ High-level output voltage	$I_{OH} = -0.675\text{ mA}$		25°C		2.6		2.6	V		
			Full range		2.45		2.45			
	$I_{OH} = -2.2\text{ mA}$		25°C		2.4		2.4			
			Full range		2.1		2.1			
$V_{OL}$ Low-level output voltage	$V_{IC} = 1.35\text{ V}$ , $I_{OL} = 0.675\text{ mA}$		25°C		0.1		0.1	V		
			Full range			0.2			0.2	
	$V_{IC} = 1.35\text{ V}$ , $I_{OL} = 2.2\text{ mA}$		25°C		0.21		0.21			
			Full range			0.6			0.6	
$A_{VD}$ Large-signal differential voltage amplification	$V_{IC} = 1.35\text{ V}$ , $V_O = 0.6\text{ V to } 2.1\text{ V}$	$R_L = 10\text{ k}\Omega$ ‡	25°C	20	380		20	380	V/mV	
			Full range		13		13			
$r_{i(d)}$ Differential input resistance			25°C		$10^{12}$		$10^{12}$	$\Omega$		
$C_{i(c)}$ Common-mode input capacitance	$f = 10\text{ kHz}$ ,		25°C		8		8	pF		
$Z_o$ Closed-loop output impedance	$f = 100\text{ kHz}$ , $A_V = 10$		25°C		25		25	$\Omega$		
CMRR Common-mode rejection ratio	$V_{IC} = V_{ICR}(\text{min})$ , $R_S = 50\ \Omega$	$V_O = 1.5\text{ V}$	25°C	60	84		60	84	dB	
			Full range		60	82		60		82
$k_{SVR}$ Supply voltage rejection ratio ( $\Delta V_{DD} / \Delta V_{IO}$ )	$V_{DD} = 2.7\text{ V to } 5\text{ V}$ , No load	$V_{IC} = V_{DD}/2$	25°C	70	89		70	89	dB	
			Full range		70	84		70		84
$I_{DD}$ Supply current (per channel)	$V_O = 1.5\text{ V}$ , No load		25°C		1	2		1	2	mA
			Full range			2			2	

† Full range is  $-55^\circ\text{C}$  to  $125^\circ\text{C}$  for M level part.

‡ Referenced to 1.35 V

**TLV277x-EP, TLV277xA-EP**  
**FAMILY OF 2.7-V HIGH-SLEW-RATE RAIL-TO-RAIL OUTPUT**  
**OPERATIONAL AMPLIFIERS WITH SHUTDOWN**

SGLS317A – OCTOBER 2005 – REVISED SEPTEMBER 2007

operating characteristics at specified free-air temperature,  $V_{DD} = 2.7\text{ V}$  (unless otherwise noted)

PARAMETER	TEST CONDITIONS	$T_A$ †	TLV277xM			TLV277xAM			UNIT	
			MIN	TYP	MAX	MIN	TYP	MAX		
SR	Slew rate at unity gain	$V_{O(PP)} = 0.8\text{ V}$ , $C_L = 100\text{ pF}$ , $R_L = 10\text{ k}\Omega$	25°C	5	9		5	9	V/ $\mu\text{s}$	
			Full range	4.7	6		4.7	6		
$V_n$	Equivalent input noise voltage		25°C	$f = 1\text{ kHz}$			21			nV/ $\sqrt{\text{Hz}}$
				$f = 10\text{ kHz}$			17			
$V_{N(PP)}$	Peak-to-peak equivalent input noise voltage		25°C	$f = 0.1\text{ Hz to }1\text{ Hz}$			0.33			$\mu\text{V}$
				$f = 0.1\text{ Hz to }10\text{ Hz}$			0.86			$\mu\text{V}$
$I_n$	Equivalent input noise current		25°C	$f = 100\text{ Hz}$			0.6			fA/ $\sqrt{\text{Hz}}$
THD + N	Total harmonic distortion plus noise	$R_L = 600\ \Omega$ , $f = 1\text{ kHz}$	25°C	$A_V = 1$			0.0085%			
				$A_V = 10$			0.025%			
				$A_V = 100$			0.12%			
	Gain-bandwidth product	$f = 10\text{ kHz}$ , $C_L = 100\text{ pF}$	25°C	$R_L = 600\ \Omega$			4.8			MHz
$t_s$	Settling time	$A_V = -1$ , Step = 0.85 V to 1.85 V, $R_L = 600\ \Omega$ , $C_L = 100\text{ pF}$	25°C	0.1%			0.186			$\mu\text{s}$
				0.01%			3.92			
$\phi_m$	Phase margin at unity gain	$R_L = 600\ \Omega$ , $C_L = 100\text{ pF}$	25°C	46°			46°			
	Gain margin		25°C	12			12			dB

† Full range is  $-55^\circ\text{C}$  to  $125^\circ\text{C}$  for M level part.

# TLV277x-EP, TLV277xA-EP FAMILY OF 2.7-V HIGH-SLEW-RATE RAIL-TO-RAIL OUTPUT OPERATIONAL AMPLIFIERS WITH SHUTDOWN

SGLS317A – OCTOBER 2005 – REVISED SEPTEMBER 2007

electrical characteristics at specified free-air temperature,  $V_{DD} = 5\text{ V}$  (unless otherwise noted)

PARAMETER	TEST CONDITIONS		$T_A$ †	TLV277xM			TLV277xAM			UNIT
				MIN	TYP	MAX	MIN	TYP	MAX	
$V_{IO}$ Input offset voltage	$V_{DD} = \pm 2.5\text{ V}$ , $V_{IC} = 0$ , $V_O = 0$ , $R_S = 50\ \Omega$	TLV2770/1/2/3	25°C	0.36	2.5		0.36	1.6	mV	
			Full range			2.7		1.9		
		TLV2774/5	25°C		0.8	2.5		0.8		2.1
			Full range			2.7		2.4		
$\alpha_{VIO}$ Temperature coefficient of input offset voltage	$V_{DD} = \pm 2.5\text{ V}$ , $V_{IC} = 0$ , $V_O = 0$ , $R_S = 50\ \Omega$		25°C to 125°C		2		2		$\mu\text{V}/^\circ\text{C}$	
$I_{IO}$ Input offset current	$V_{DD} = \pm 2.5\text{ V}$ , $V_{IC} = 0$ , $V_O = 0$ , $R_S = 50\ \Omega$		25°C		1	60		1	60	pA
			Full range	TLV2770/1/2/3			125		125	
				TLV2774/5			200		200	
$I_{IB}$ Input bias current	$V_{DD} = \pm 2.5\text{ V}$ , $V_{IC} = 0$ , $V_O = 0$ , $R_S = 50\ \Omega$		25°C		2	60		2	60	pA
			Full range	TLV2770/1/2/3			350		350	
				TLV2774/5			500		500	
$V_{ICR}$ Common-mode input voltage range	CMRR > 60 dB, $R_S = 50\ \Omega$		25°C	0 to 3.7	-0.3 to 3.8		0 to 3.7	-0.3 to 3.8	V	
			Full range	0 to 3.7	-0.3 to 3.8		0 to 3.7	-0.3 to 3.8		
$V_{OH}$ High-level output voltage	$I_{OH} = -1.3\text{ mA}$		25°C		4.9		4.9	V		
			Full range		4.8		4.8			
	$I_{OH} = -4.2\text{ mA}$		25°C		4.7		4.7			
			Full range		4.4		4.4			
$V_{OL}$ Low-level output voltage	$V_{IC} = 2.5\text{ V}$ , $I_{OL} = 1.3\text{ mA}$		25°C		0.1		0.1	V		
			Full range		0.2		0.2			
	$V_{IC} = 2.5\text{ V}$ , $I_{OL} = 4.2\text{ mA}$		25°C		0.21		0.21			
			Full range		0.6		0.6			
$A_{VD}$ Large-signal differential voltage amplification	$V_{IC} = 2.5\text{ V}$ , $V_O = 1\text{ V to }4\text{ V}$	$R_L = 10\text{ k}\Omega$ , ‡	25°C	20	450		20	450	V/mV	
			Full range		13		13			
$r_{i(d)}$ Differential input resistance			25°C		1012		1012	$\Omega$		
$C_{i(c)}$ Common-mode input capacitance	$f = 10\text{ kHz}$ ,		25°C		8		8	pF		
$Z_o$ Closed-loop output impedance	$f = 100\text{ kHz}$ ,	$A_V = 10$	25°C		20		20	$\Omega$		
CMRR Common-mode rejection ratio	$V_{IC} = V_{ICR}(\text{min})$ , $R_S = 50\ \Omega$	$V_O = 3.7\text{ V}$ ,	25°C	60	96		60	96	dB	
			Full range	60	93		60	93		
$k_{SVR}$ Supply voltage rejection ratio ( $\Delta V_{DD} / \Delta V_{IO}$ )	$V_{DD} = 2.7\text{ V to }5\text{ V}$ , No load	$V_{IC} = V_{DD}/2$ ,	25°C	70	89		70	89	dB	
			Full range	70	84		70	84		
$I_{DD}$ Supply current (per channel)	$V_O = 1.5\text{ V}$ ,	No load	25°C		1	2		1	2	mA
			Full range			2		2		

† Full range is  $-55^\circ\text{C}$  to  $125^\circ\text{C}$  for M level part.

‡ Referenced to 2.5 V



**TLV277x-EP, TLV277xA-EP**  
**FAMILY OF 2.7-V HIGH-SLEW-RATE RAIL-TO-RAIL OUTPUT**  
**OPERATIONAL AMPLIFIERS WITH SHUTDOWN**

SGLS317A – OCTOBER 2005 – REVISED SEPTEMBER 2007

operating characteristics at specified free-air temperature,  $V_{DD} = 5\text{ V}$  (unless otherwise noted)

PARAMETER	TEST CONDITIONS	$T_A$ †	TLV277xM			TLV2772xAM			UNIT	
			MIN	TYP	MAX	MIN	TYP	MAX		
SR	Slew rate at unity gain	$V_{O(PP)} = 1.5\text{ V}$ , $C_L = 100\text{ pF}$ , $R_L = 10\text{ k}\Omega$	25°C	5	10.5		5	10.5	V/ $\mu\text{s}$	
			Full range	4.7	6		4.7	6		
$V_n$	Equivalent input noise voltage		25°C	$f = 1\text{ kHz}$			17			nV/ $\sqrt{\text{Hz}}$
				$f = 10\text{ kHz}$			12			
$V_{N(PP)}$	Peak-to-peak equivalent input noise voltage		25°C	$f = 0.1\text{ Hz to }1\text{ Hz}$			0.33			$\mu\text{V}$
				$f = 0.1\text{ Hz to }10\text{ Hz}$			0.86			$\mu\text{V}$
$I_n$	Equivalent input noise current		25°C	$f = 100\text{ Hz}$			0.6			fA/ $\sqrt{\text{Hz}}$
THD + N	Total harmonic distortion plus noise	$R_L = 600\ \Omega$ , $f = 1\text{ kHz}$	25°C	$A_V = 1$			0.005%			
				$A_V = 10$			0.016%			
				$A_V = 100$			0.095%			
	Gain-bandwidth product	$f = 10\text{ kHz}$ , $C_L = 100\text{ pF}$	25°C	$R_L = 600\ \Omega$			5.1			MHz
$t_s$	Settling time	$A_V = -1$ , Step = 1.5 V to 3.5 V, $R_L = 600\ \Omega$ , $C_L = 100\text{ pF}$	25°C	0.1%			0.134			$\mu\text{s}$
				0.01%			1.97			
$\phi_m$	Phase margin at unity gain	$R_L = 600\ \Omega$ , $C_L = 100\text{ pF}$	25°C	46°			46°			
	Gain margin		25°C	12			12			dB

† Full range is  $-55^\circ\text{C}$  to  $125^\circ\text{C}$  for M level part.

**TLV277x-EP, TLV277xA-EP**  
**FAMILY OF 2.7-V HIGH-SLEW-RATE RAIL-TO-RAIL OUTPUT**  
**OPERATIONAL AMPLIFIERS WITH SHUTDOWN**

SGLS317A – OCTOBER 2005 – REVISED SEPTEMBER 2007

**TYPICAL CHARACTERISTICS**

**Table of Graphs**

			<b>FIGURE</b>
$V_{IO}$	Input offset voltage	Distribution	1,2
		vs Common-mode input voltage	3,4
		Distribution	5,6
$I_{IB}/I_{IO}$	Input bias and input offset currents	vs Free-air temperature	7
$V_{OH}$	High-level output voltage	vs High-level output current	8,9
$V_{OL}$	Low-level output voltage	vs Low-level output current	10,11
$V_{O(PP)}$	Maximum peak-to-peak output voltage	vs Frequency	12,13
$I_{OS}$	Short-circuit output current	vs Supply voltage	14
		vs Free-air temperature	15
$V_O$	Output voltage	vs Differential input voltage	16
$A_{VD}$	Large-signal differential voltage amplification and phase margin	vs Frequency	17,18
$A_{VD}$	Differential voltage amplification	vs Load resistance	19
		vs Free-air temperature	20,21
$z_o$	Output impedance	vs Frequency	22,23
CMRR	Common-mode rejection ratio	vs Frequency	24
		vs Free-air temperature	25
$k_{SVR}$	Supply-voltage rejection ratio	vs Frequency	26,27
$I_{DD}$	Supply current (per channel)	vs Supply voltage	28
SR	Slew rate	vs Load capacitance	29
		vs Free-air temperature	30
$V_O$	Voltage-follower small-signal pulse response		31,32
$V_O$	Voltage-follower large-signal pulse response		33,34
$V_O$	Inverting small-signal pulse response		35,36
$V_O$	Inverting large-signal pulse response		37,38
$V_n$	Equivalent input noise voltage	vs Frequency	39,40
		Noise voltage (referred to input)	Over a 10 second period
THD + N	Total harmonic distortion plus noise	vs Frequency	42,43
		Gain-bandwidth product	vs Supply voltage
$B_1$	Unity-gain bandwidth	vs Load capacitance	45
$\phi_m$	Phase margin	vs Load capacitance	46
		Gain margin	vs Load capacitance
	Amplifier with shutdown pulse turnon/off characteristics		48 – 50
	Supply current with shutdown pulse turnon/off characteristics		51 – 53
	Shutdown supply current	vs Free-air temperature	54
	Shutdown forward/reverse isolation	vs Frequency	55, 56



**TYPICAL CHARACTERISTICS**

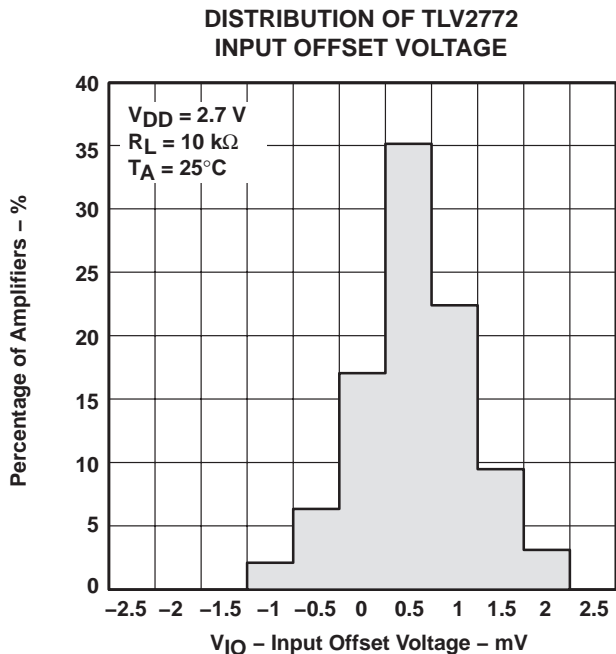

**Figure 2**

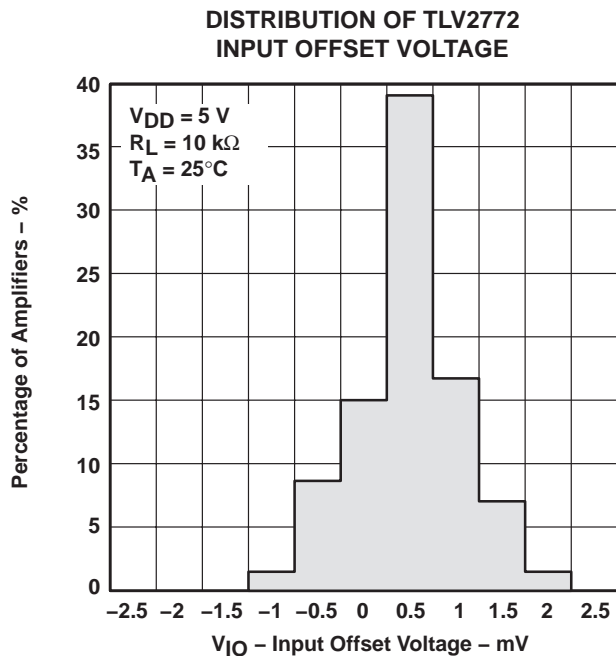

**Figure 3**

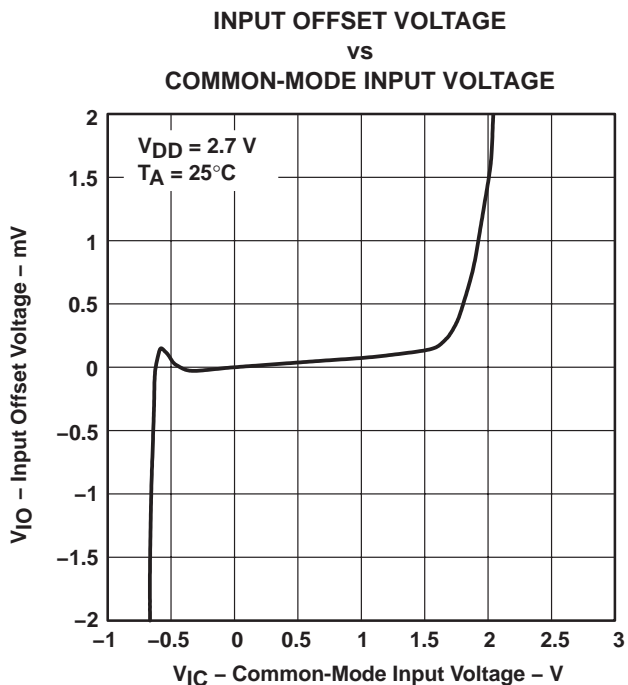

**Figure 4**

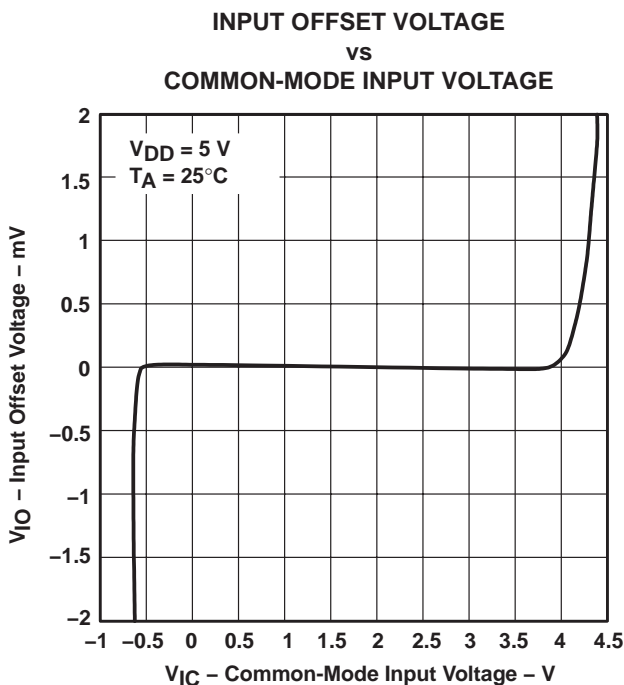

**Figure 5**

**TLV277x-EP, TLV277xA-EP**  
**FAMILY OF 2.7-V HIGH-SLEW-RATE RAIL-TO-RAIL OUTPUT**  
**OPERATIONAL AMPLIFIERS WITH SHUTDOWN**

SGLS317A – OCTOBER 2005 – REVISED SEPTEMBER 2007

**TYPICAL CHARACTERISTICS**

**DISTRIBUTION OF TLV2772**  
**INPUT OFFSET VOLTAGE**

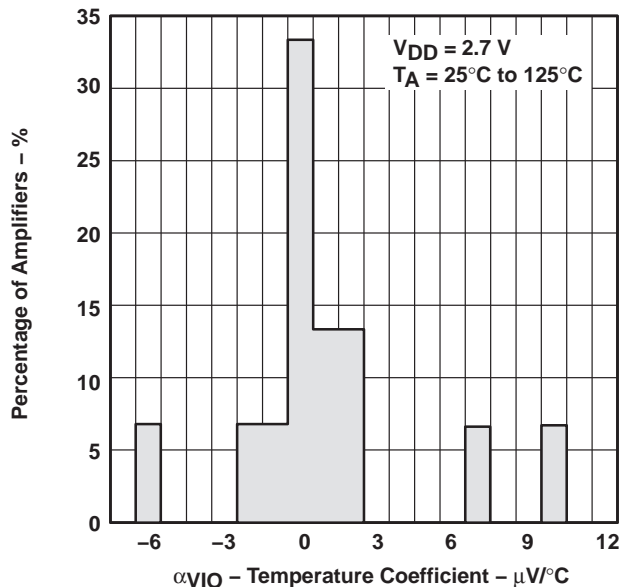

**Figure 6**

**DISTRIBUTION OF TLV2772**  
**INPUT OFFSET VOLTAGE**

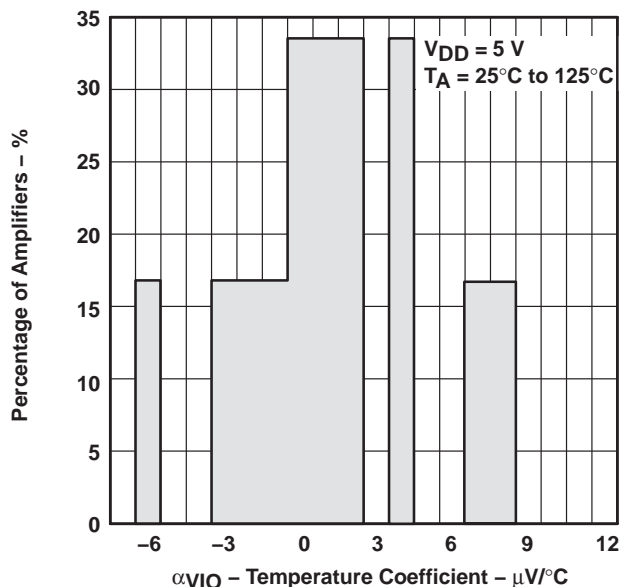

**Figure 7**

**INPUT BIAS AND OFFSET CURRENT**  
**vs**  
**FREE-AIR TEMPERATURE**

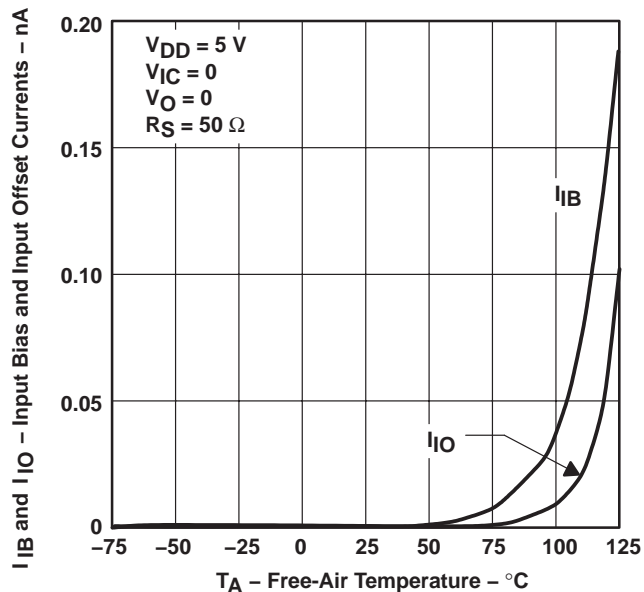

**Figure 8**

**HIGH-LEVEL OUTPUT VOLTAGE**  
**vs**  
**HIGH-LEVEL OUTPUT CURRENT**

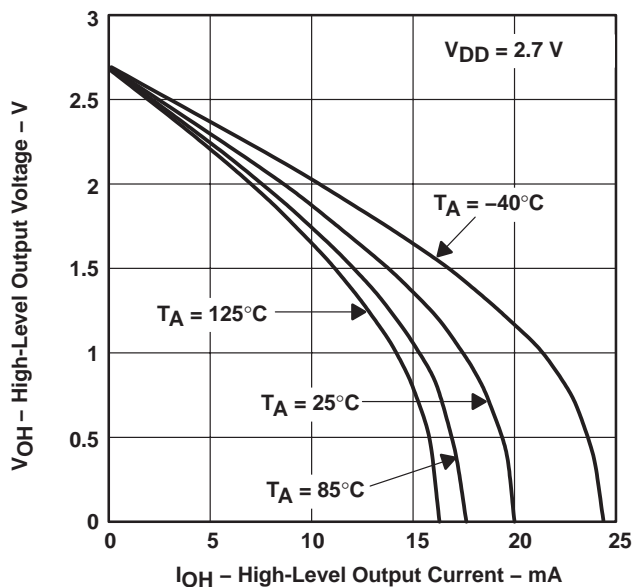

**Figure 9**



**TLV277x-EP, TLV277xA-EP**  
**FAMILY OF 2.7-V HIGH-SLEW-RATE RAIL-TO-RAIL OUTPUT**  
**OPERATIONAL AMPLIFIERS WITH SHUTDOWN**

SGLS317A – OCTOBER 2005 – REVISED SEPTEMBER 2007

**TYPICAL CHARACTERISTICS**

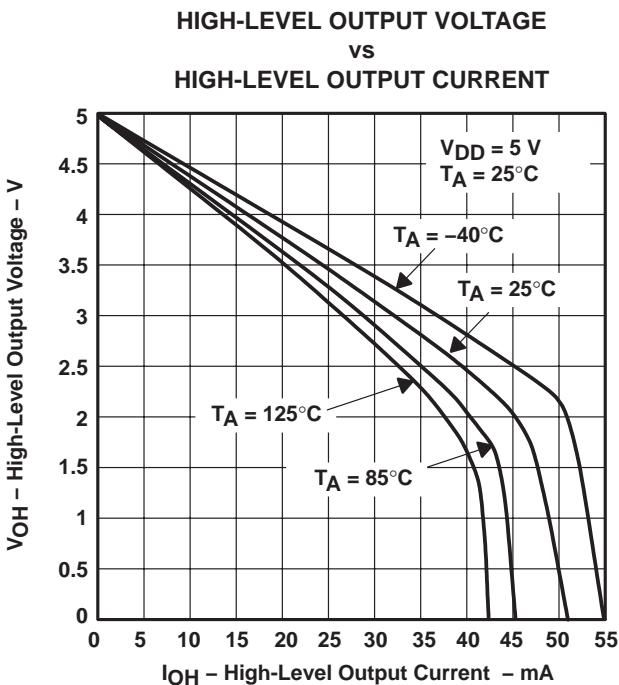

Figure 10

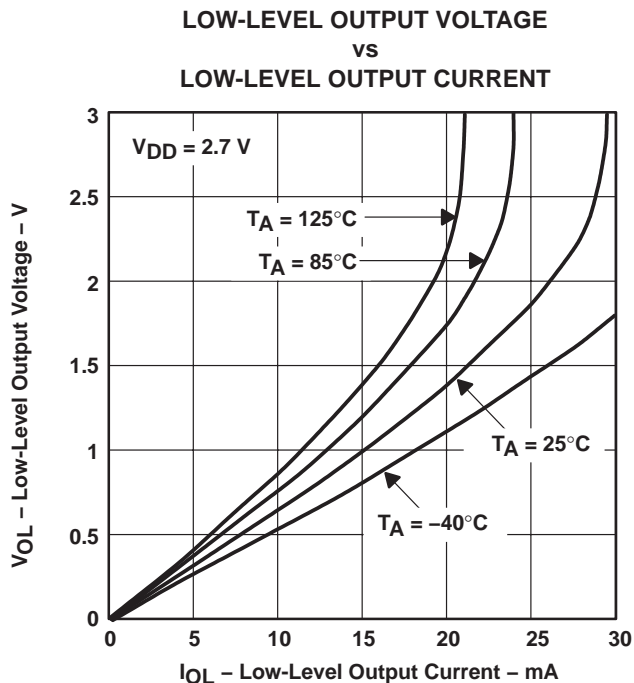

Figure 11

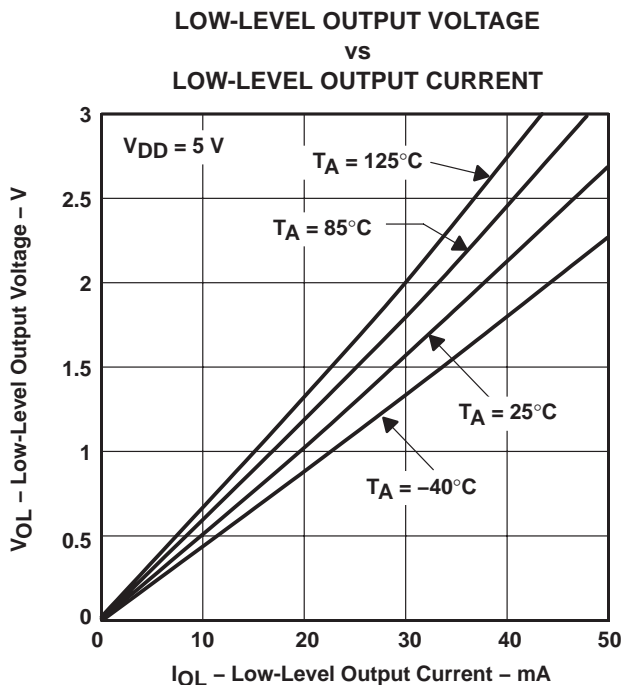

Figure 12

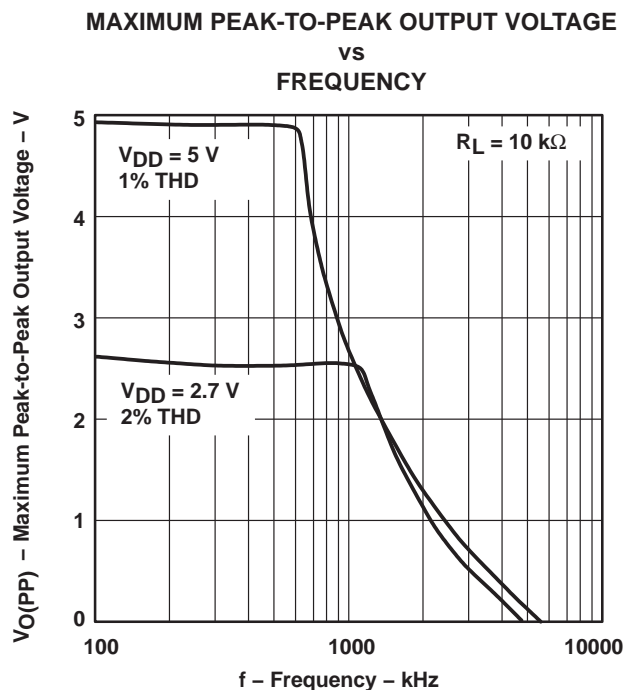

Figure 13

**TLV277x-EP, TLV277xA-EP**  
**FAMILY OF 2.7-V HIGH-SLEW-RATE RAIL-TO-RAIL OUTPUT**  
**OPERATIONAL AMPLIFIERS WITH SHUTDOWN**

SGLS317A – OCTOBER 2005 – REVISED SEPTEMBER 2007

**TYPICAL CHARACTERISTICS**

**MAXIMUM PEAK-TO-PEAK OUTPUT VOLTAGE**  
**vs**  
**FREQUENCY**

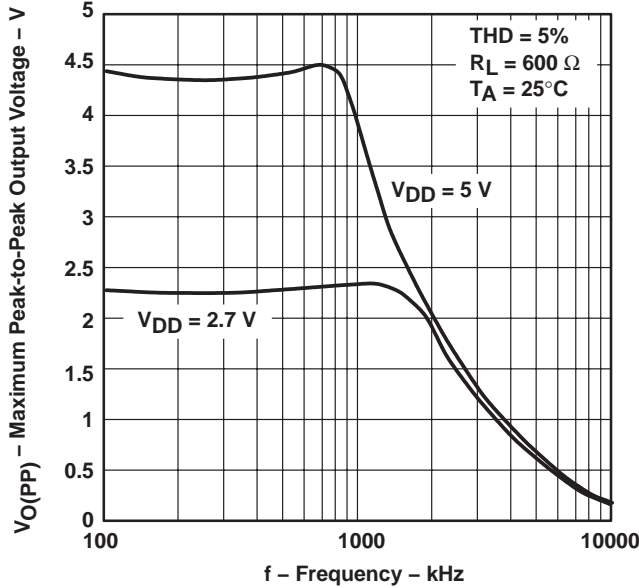

**Figure 14**

**SHORT-CIRCUIT OUTPUT CURRENT**  
**vs**  
**SUPPLY VOLTAGE**

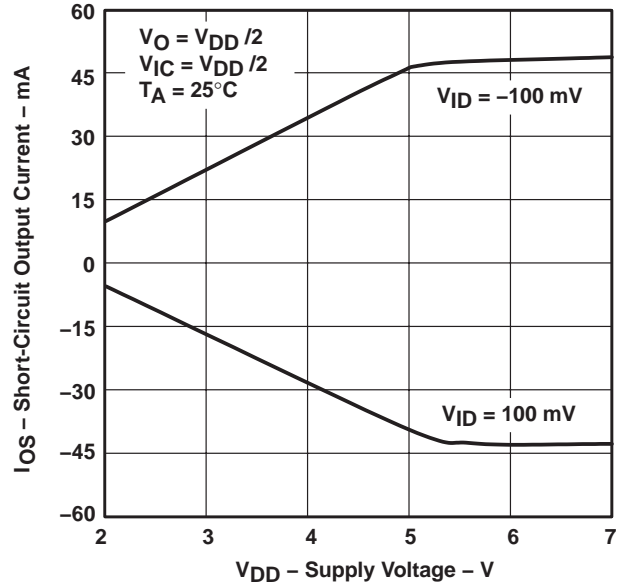

**Figure 15**

**SHORT-CIRCUIT OUTPUT CURRENT**  
**vs**  
**FREE-AIR TEMPERATURE**

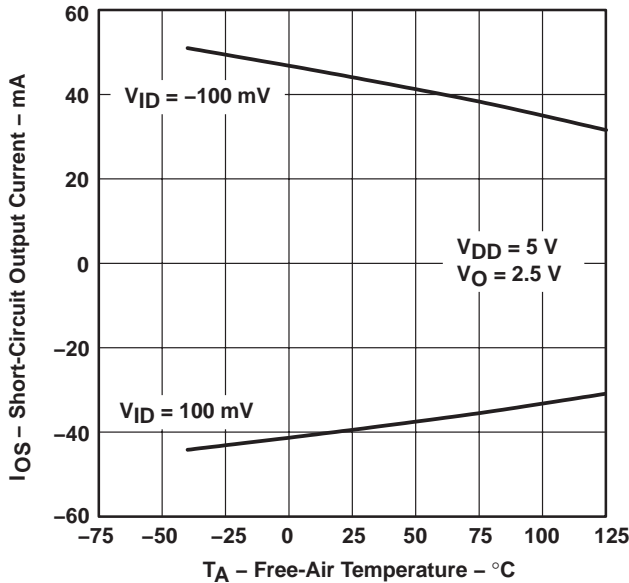

**Figure 16**

**OUTPUT VOLTAGE**  
**vs**  
**DIFFERENTIAL INPUT VOLTAGE**

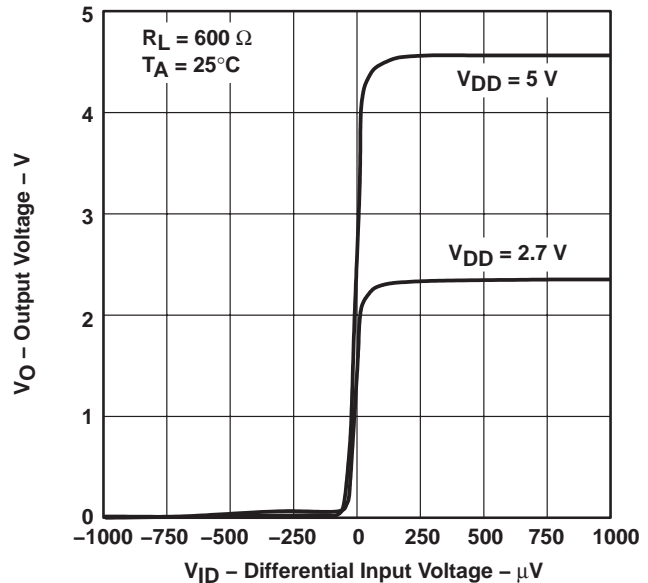

**Figure 17**



**TLV277x-EP, TLV277xA-EP**  
**FAMILY OF 2.7-V HIGH-SLEW-RATE RAIL-TO-RAIL OUTPUT**  
**OPERATIONAL AMPLIFIERS WITH SHUTDOWN**

SGLS317A – OCTOBER 2005 – REVISED SEPTEMBER 2007

**TYPICAL CHARACTERISTICS**

**LARGE-SIGNAL DIFFERENTIAL VOLTAGE AMPLIFICATION**  
**AND PHASE MARGIN**

vs  
**FREQUENCY**

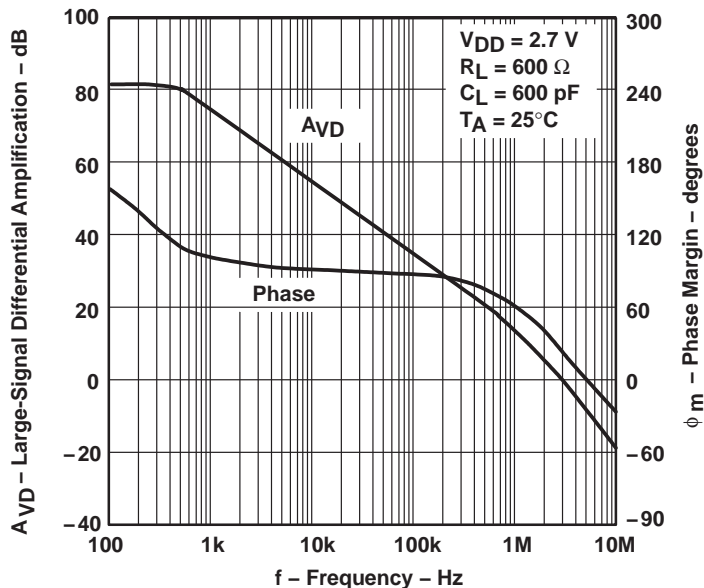

Figure 18

**LARGE-SIGNAL DIFFERENTIAL VOLTAGE AMPLIFICATION**  
**AND PHASE MARGIN**

vs  
**FREQUENCY**

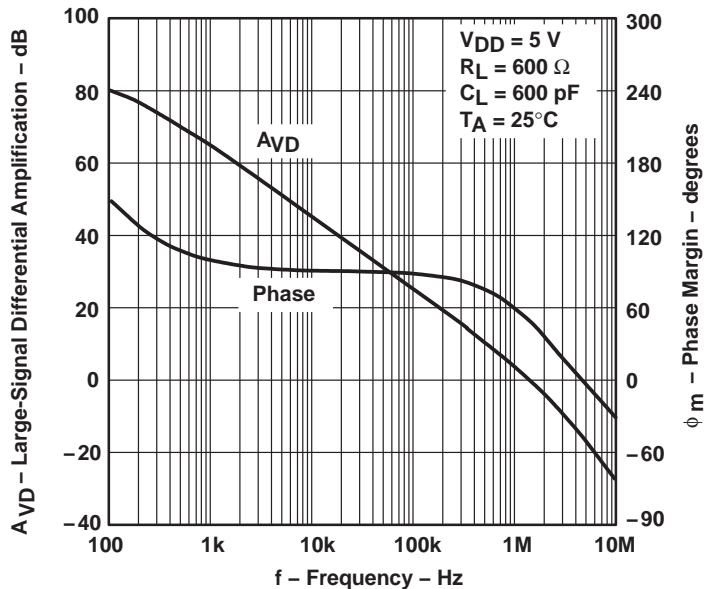

Figure 19

**TLV277x-EP, TLV277xA-EP**  
**FAMILY OF 2.7-V HIGH-SLEW-RATE RAIL-TO-RAIL OUTPUT**  
**OPERATIONAL AMPLIFIERS WITH SHUTDOWN**

SGLS317A – OCTOBER 2005 – REVISED SEPTEMBER 2007

**TYPICAL CHARACTERISTICS**

**DIFFERENTIAL VOLTAGE AMPLIFICATION**  
**vs**  
**LOAD RESISTANCE**

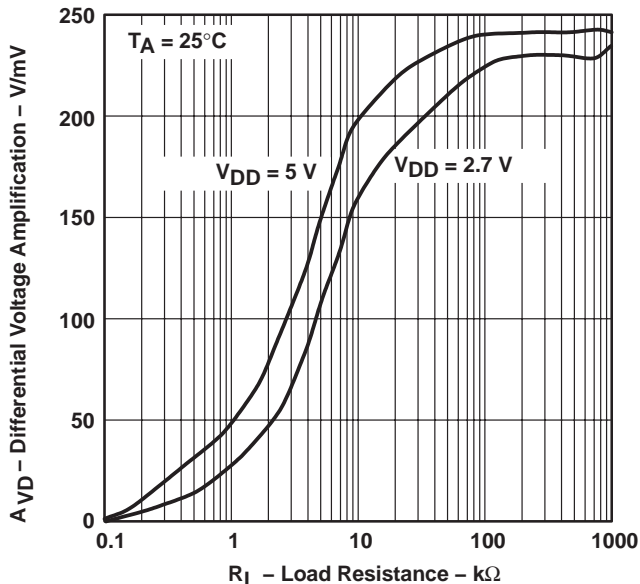

**Figure 20**

**DIFFERENTIAL VOLTAGE AMPLIFICATION**  
**vs**  
**FREE-AIR TEMPERATURE**

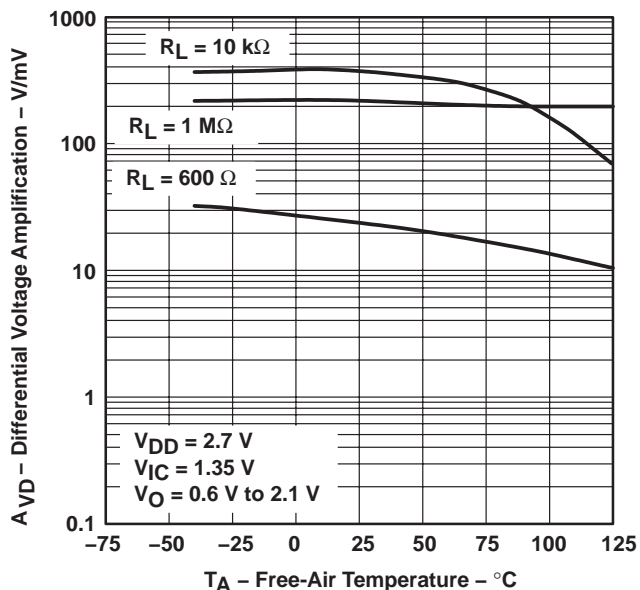

**Figure 21**

**DIFFERENTIAL VOLTAGE AMPLIFICATION**  
**vs**  
**FREE-AIR TEMPERATURE**

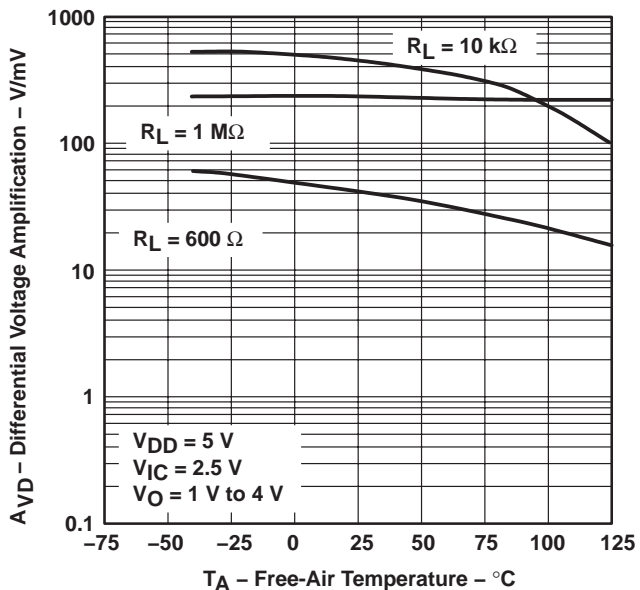

**Figure 22**

**OUTPUT IMPEDANCE**  
**vs**  
**FREQUENCY**

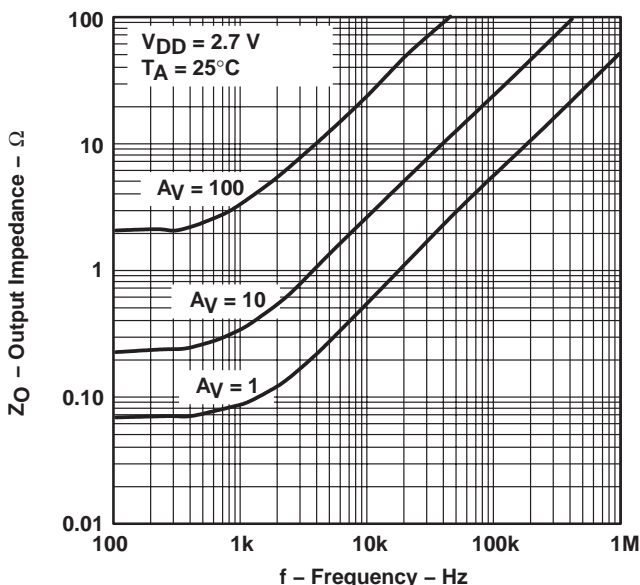

**Figure 23**





TYPICAL CHARACTERISTICS

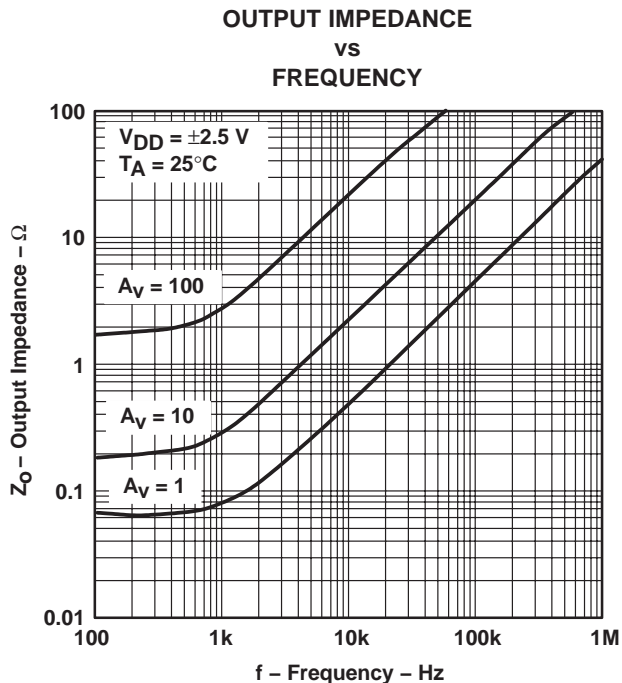

Figure 24

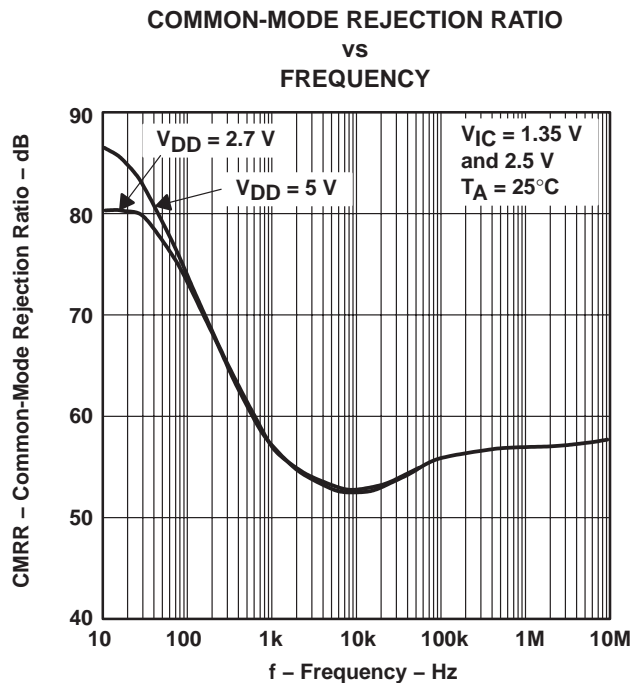

Figure 25

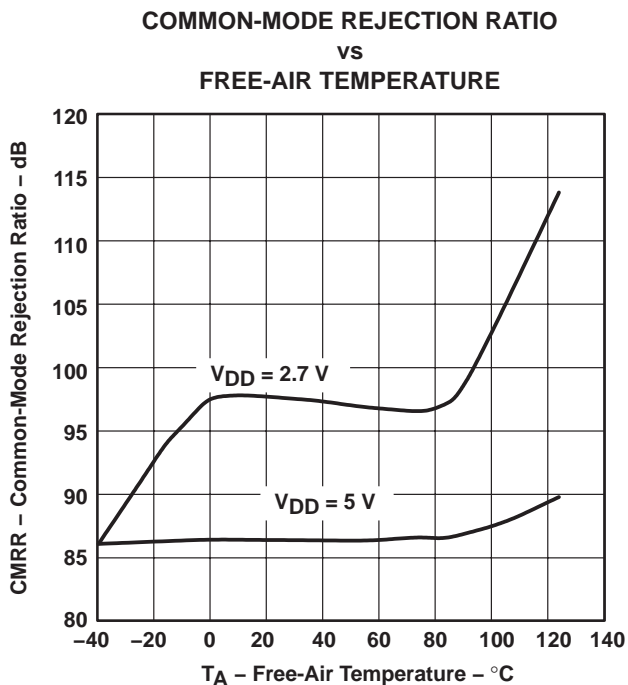

Figure 26

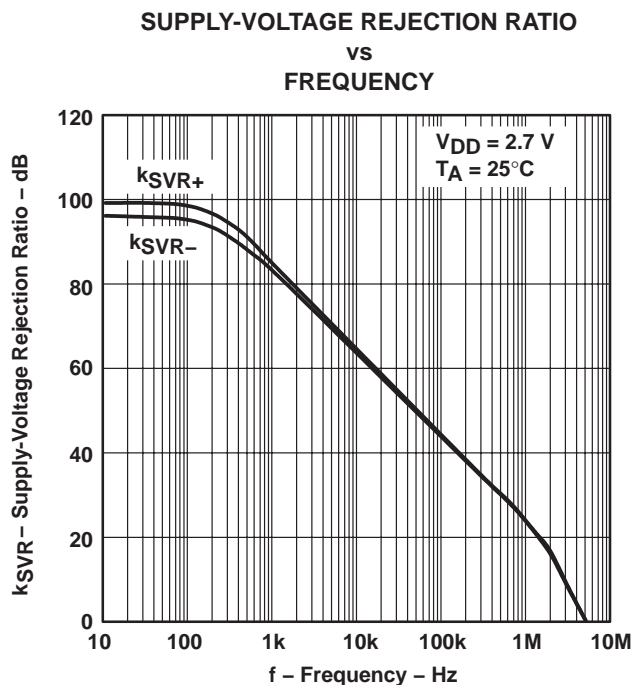

Figure 27

**TLV277x-EP, TLV277xA-EP**  
**FAMILY OF 2.7-V HIGH-SLEW-RATE RAIL-TO-RAIL OUTPUT**  
**OPERATIONAL AMPLIFIERS WITH SHUTDOWN**

SGLS317A – OCTOBER 2005 – REVISED SEPTEMBER 2007

**TYPICAL CHARACTERISTICS**

**SUPPLY VOLTAGE REJECTION RATIO**  
**vs**  
**FREQUENCY**

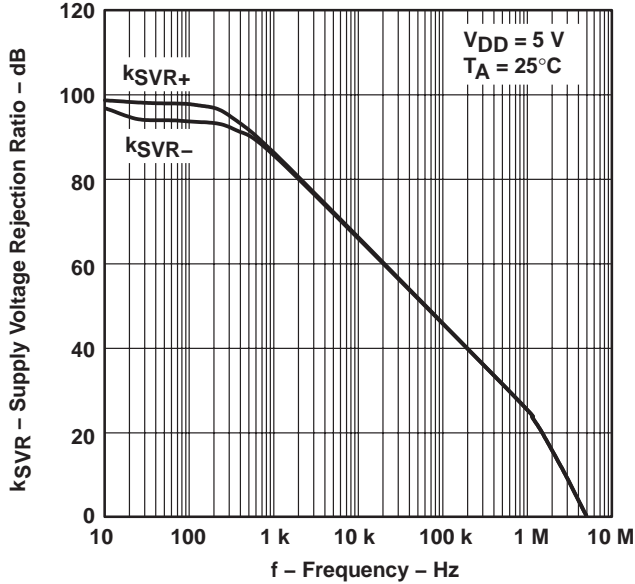

**Figure 28**

**SUPPLY CURRENT (PER CHANNEL)**  
**vs**  
**SUPPLY VOLTAGE**

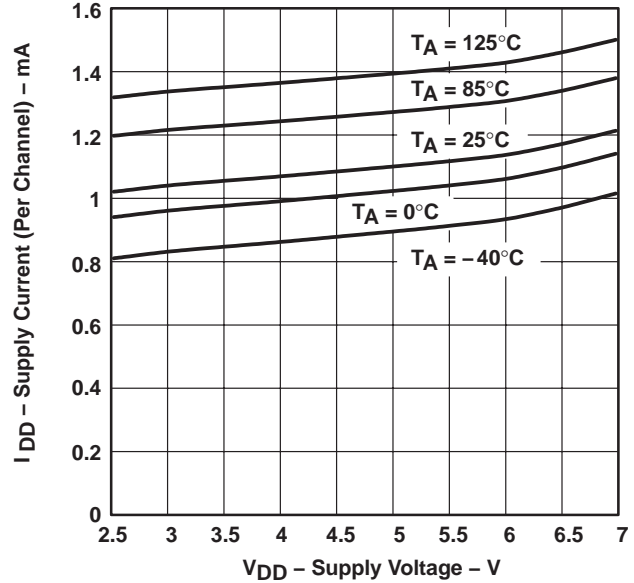

**Figure 29**

**SLEW RATE**  
**vs**  
**LOAD CAPACITANCE**

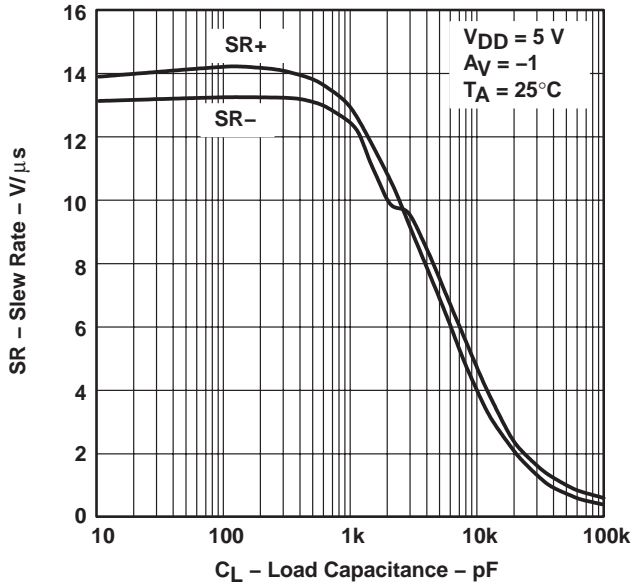

**Figure 30**

**SLEW RATE**  
**vs**  
**FREE-AIR TEMPERATURE**

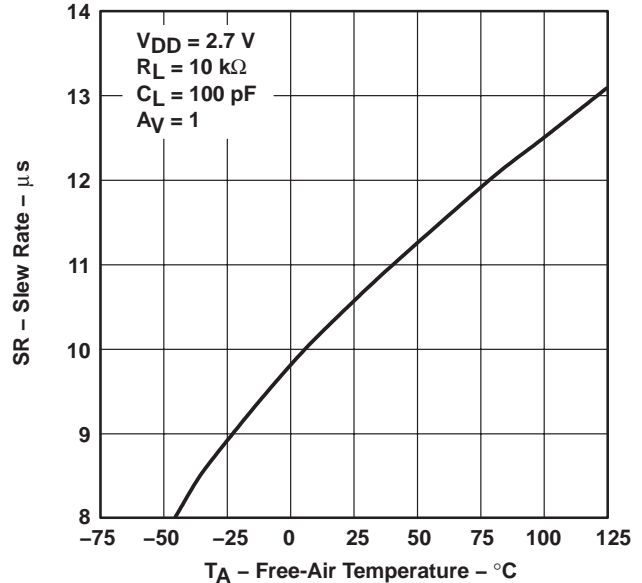

**Figure 31**



TYPICAL CHARACTERISTICS

VOLTAGE-FOLLOWER  
 SMALL-SIGNAL PULSE RESPONSE

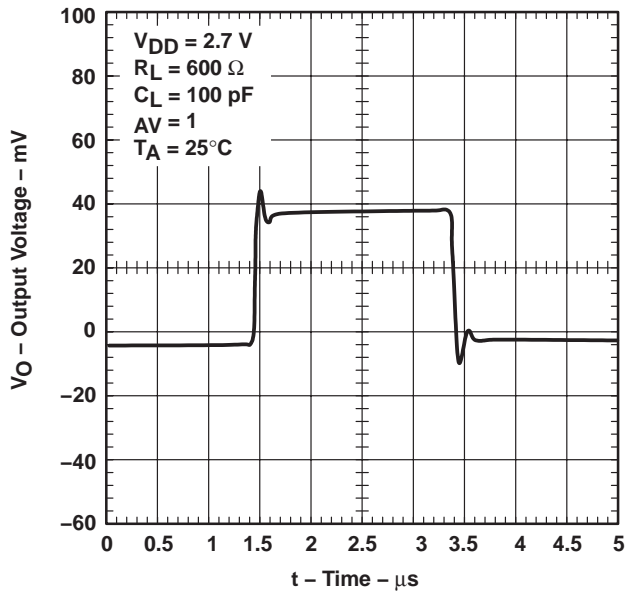

Figure 32

VOLTAGE-FOLLOWER  
 SMALL-SIGNAL PULSE RESPONSE

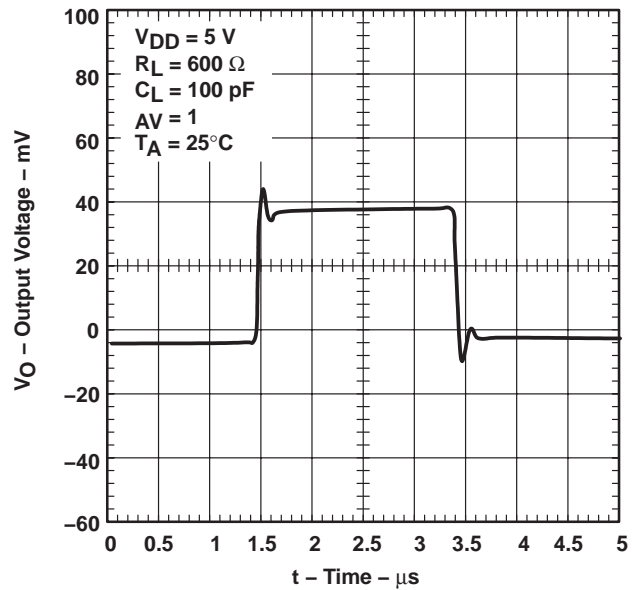

Figure 33

VOLTAGE-FOLLOWER  
 LARGE-SIGNAL PULSE RESPONSE

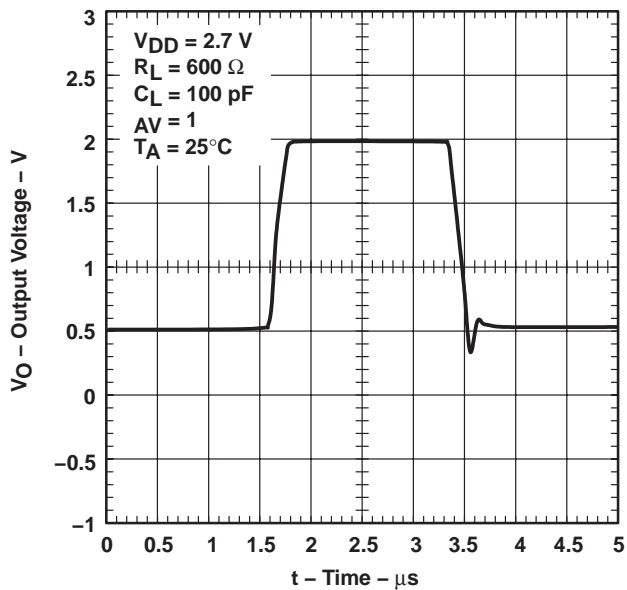

Figure 34

VOLTAGE-FOLLOWER  
 LARGE-SIGNAL PULSE RESPONSE

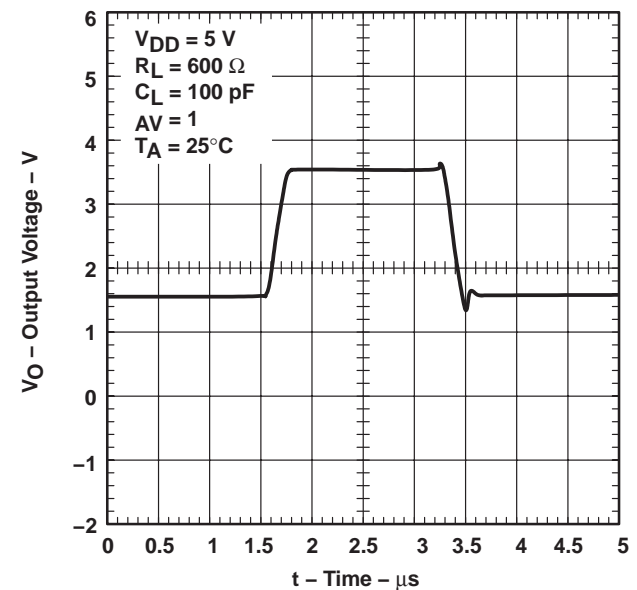

Figure 35

**TLV277x-EP, TLV277xA-EP**  
**FAMILY OF 2.7-V HIGH-SLEW-RATE RAIL-TO-RAIL OUTPUT**  
**OPERATIONAL AMPLIFIERS WITH SHUTDOWN**

SGLS317A – OCTOBER 2005 – REVISED SEPTEMBER 2007

**TYPICAL CHARACTERISTICS**

**INVERTING SMALL-SIGNAL PULSE RESPONSE**

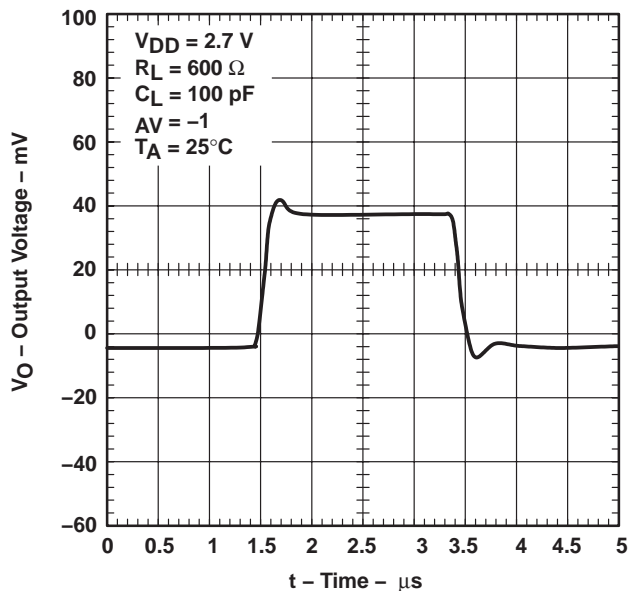

**Figure 36**

**INVERTING SMALL-SIGNAL PULSE RESPONSE**

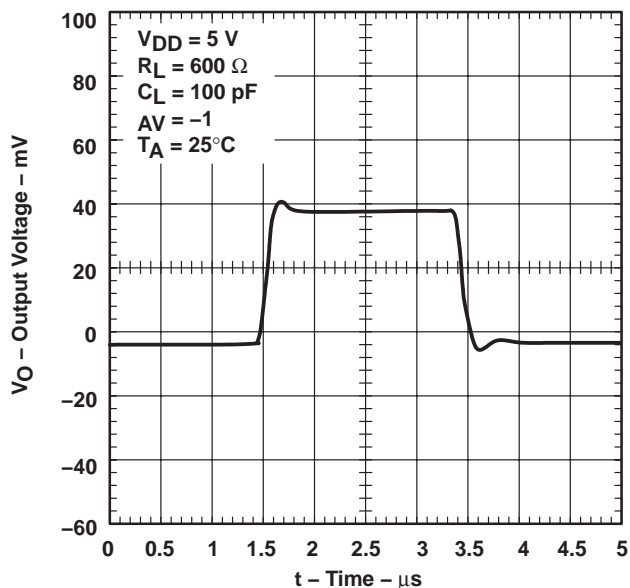

**Figure 37**

**INVERTING LARGE-SIGNAL PULSE RESPONSE**

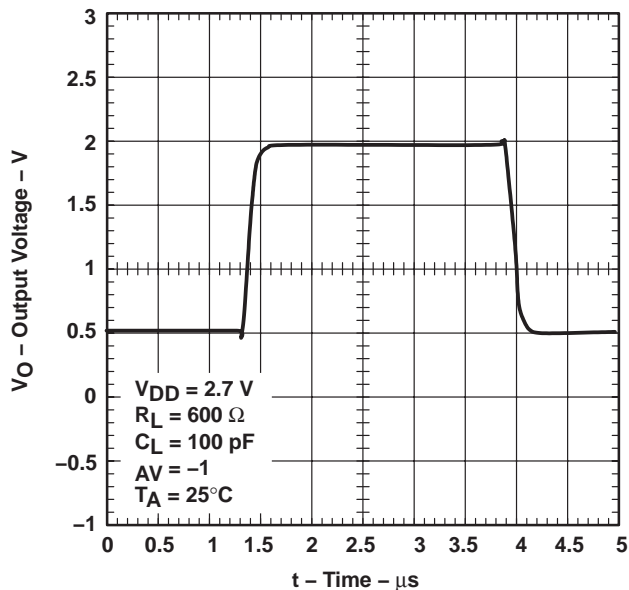

**Figure 38**

**INVERTING LARGE-SIGNAL PULSE RESPONSE**

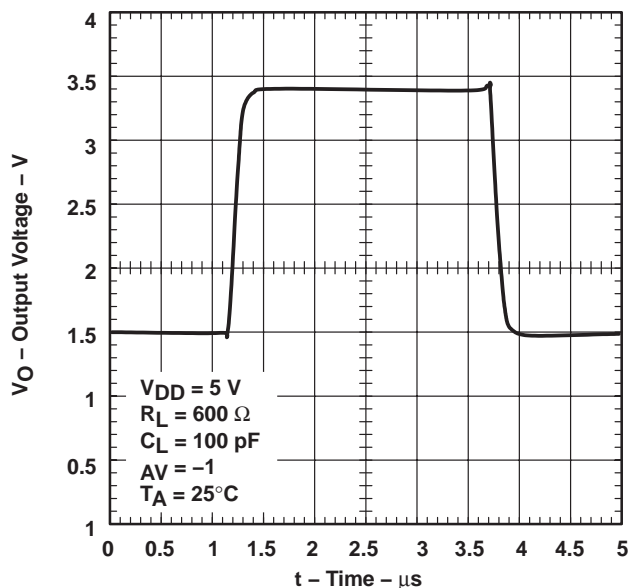

**Figure 39**



**TLV277x-EP, TLV277xA-EP**  
**FAMILY OF 2.7-V HIGH-SLEW-RATE RAIL-TO-RAIL OUTPUT**  
**OPERATIONAL AMPLIFIERS WITH SHUTDOWN**

SGLS317A – OCTOBER 2005 – REVISED SEPTEMBER 2007

**TYPICAL CHARACTERISTICS**

**EQUIVALENT INPUT NOISE VOLTAGE  
vs  
FREQUENCY**

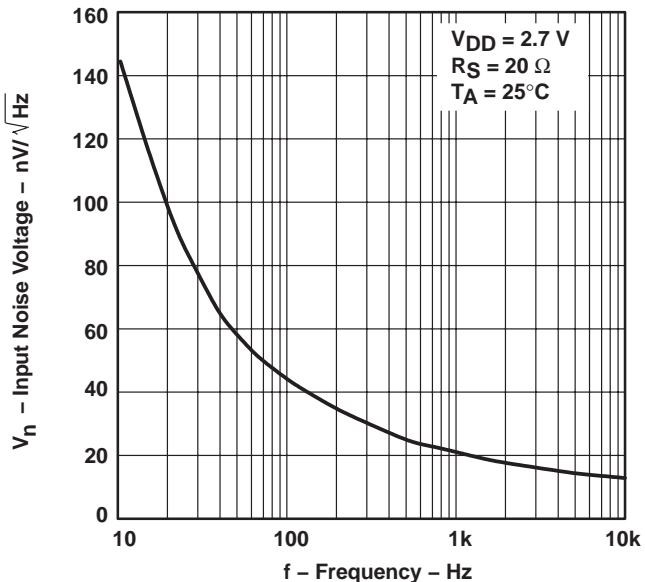

**Figure 40**

**EQUIVALENT INPUT NOISE VOLTAGE  
vs  
FREQUENCY**

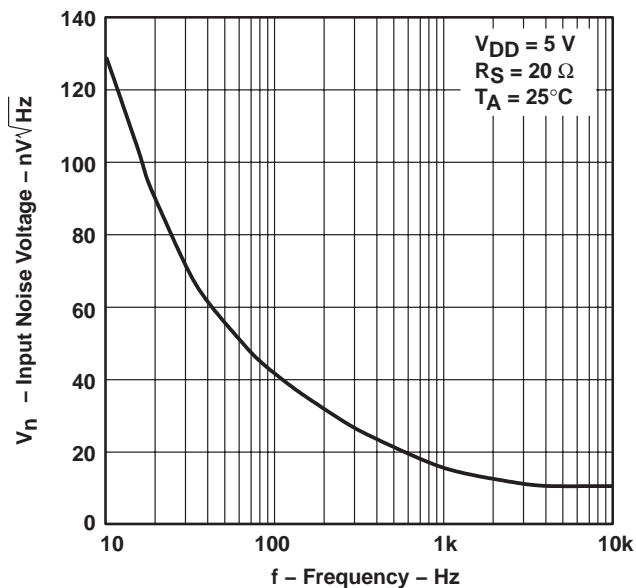

**Figure 41**

**NOISE VOLTAGE  
OVER A 10 SECOND PERIOD**

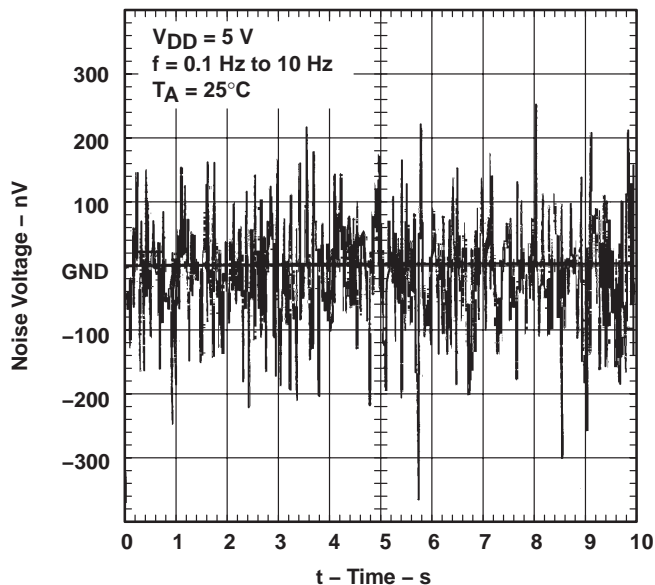

**Figure 42**

**TLV277x-EP, TLV277xA-EP**  
**FAMILY OF 2.7-V HIGH-SLEW-RATE RAIL-TO-RAIL OUTPUT**  
**OPERATIONAL AMPLIFIERS WITH SHUTDOWN**

SGLS317A – OCTOBER 2005 – REVISED SEPTEMBER 2007

**TYPICAL CHARACTERISTICS**

**TOTAL HARMONIC DISTORTION PLUS NOISE**  
**vs**  
**FREQUENCY**

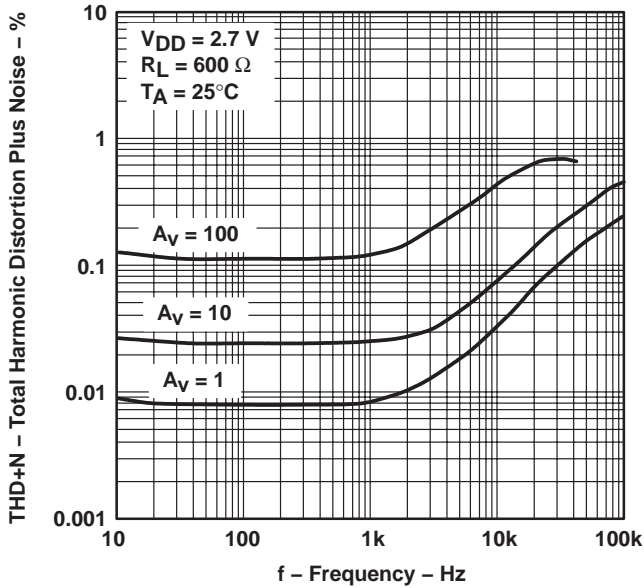

**Figure 43**

**TOTAL HARMONIC DISTORTION PLUS NOISE**  
**vs**  
**FREQUENCY**

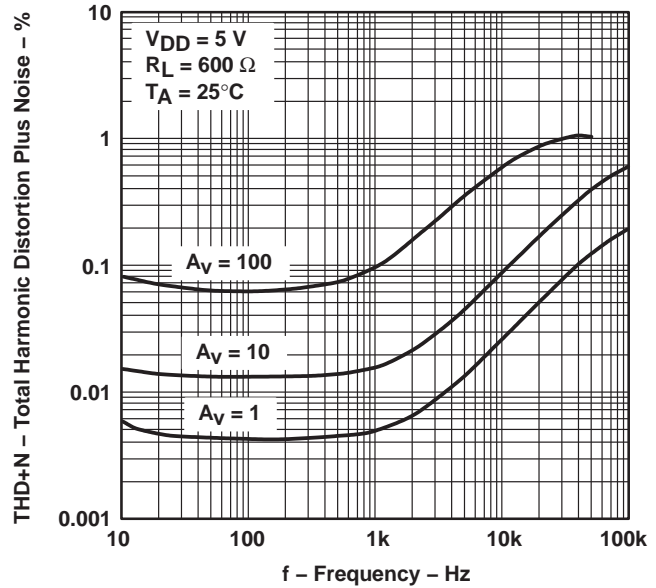

**Figure 44**

**GAIN-BANDWIDTH PRODUCT**  
**vs**  
**SUPPLY VOLTAGE**

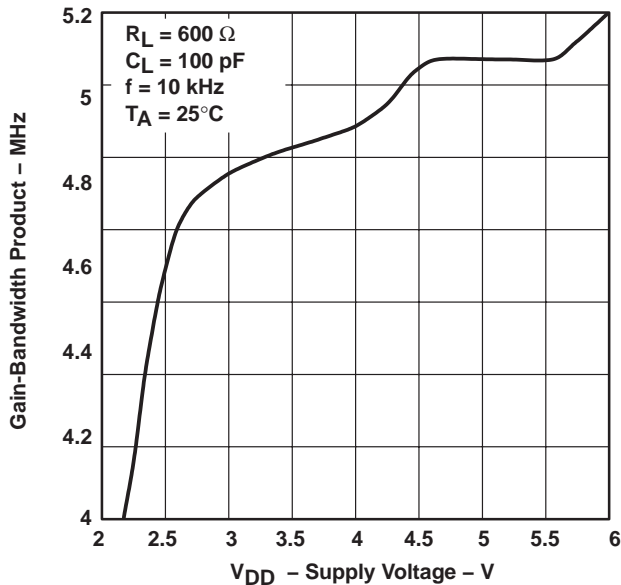

**Figure 45**

**UNITY-GAIN BANDWIDTH**  
**vs**  
**LOAD CAPACITANCE**

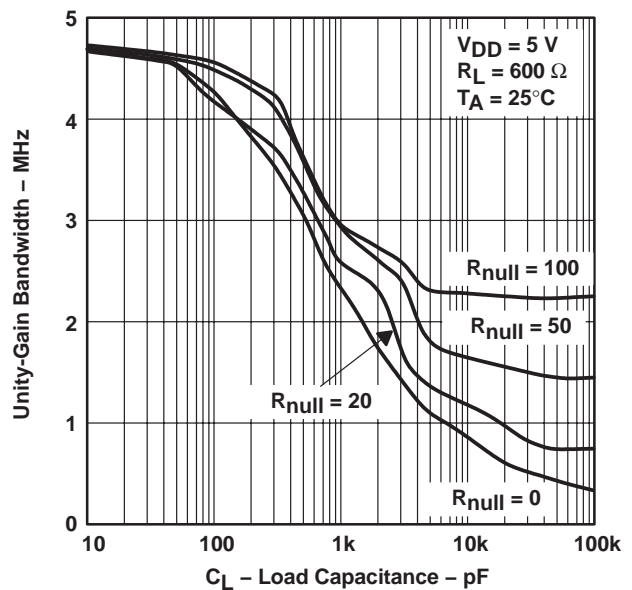

**Figure 46**



**TLV277x-EP, TLV277xA-EP**  
**FAMILY OF 2.7-V HIGH-SLEW-RATE RAIL-TO-RAIL OUTPUT**  
**OPERATIONAL AMPLIFIERS WITH SHUTDOWN**

SGLS317A – OCTOBER 2005 – REVISED SEPTEMBER 2007

**TYPICAL CHARACTERISTICS**

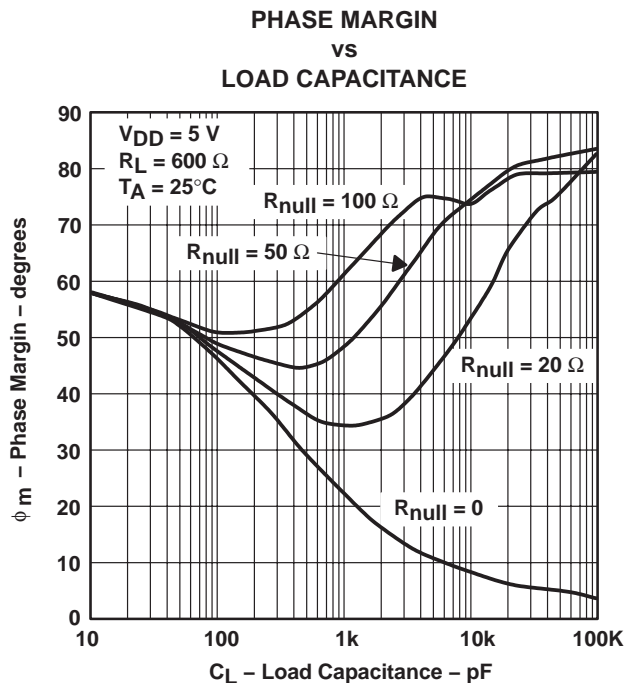

Figure 47

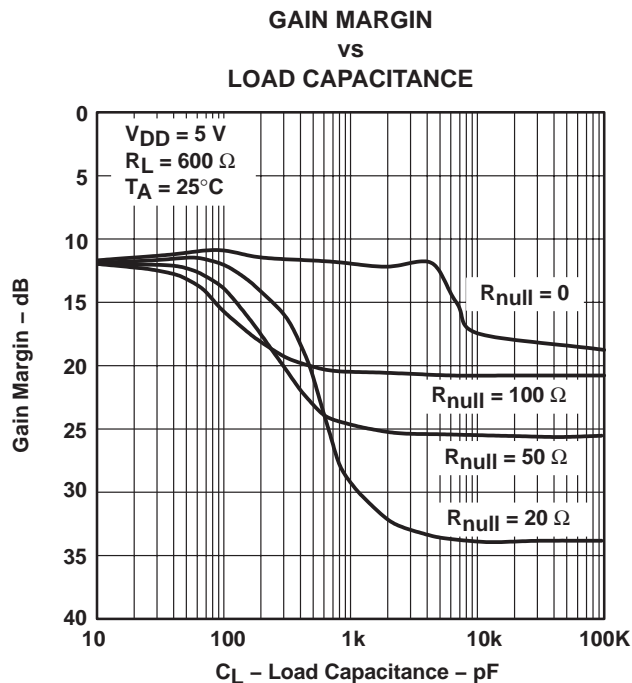

Figure 48

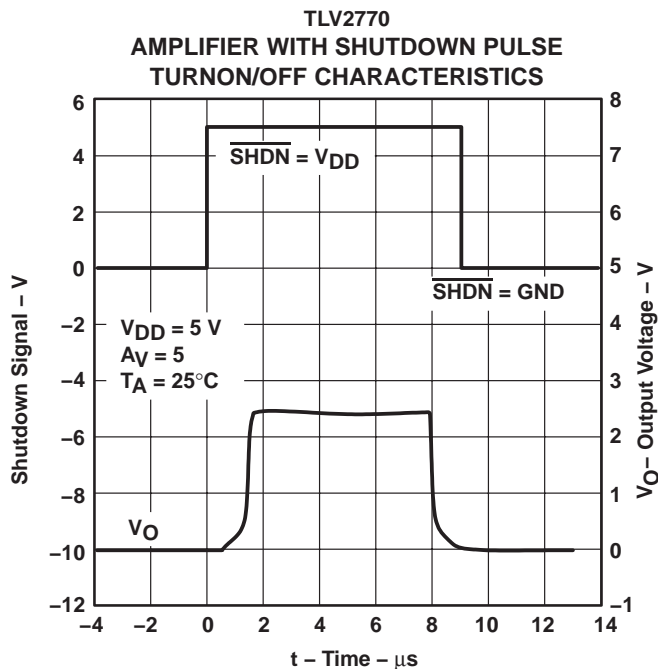

Figure 49

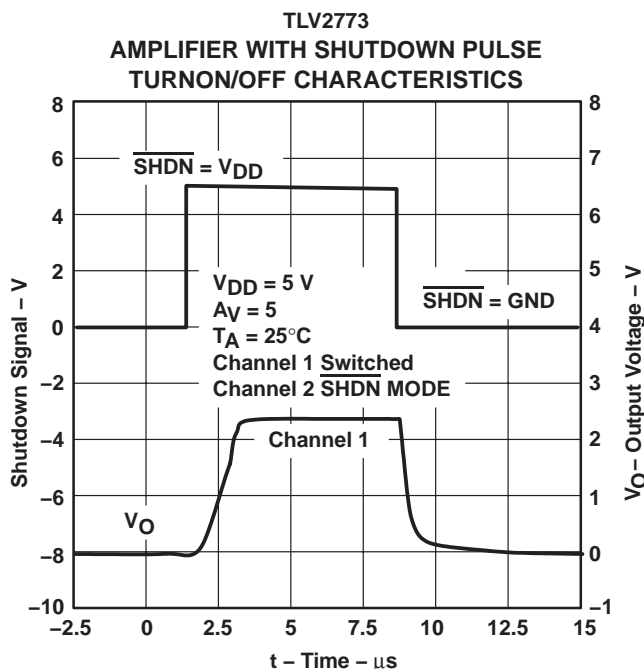
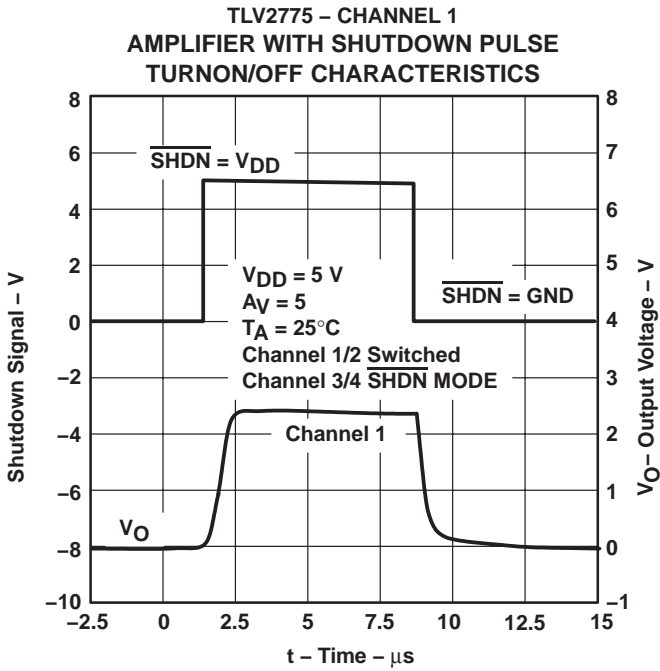

Figure 50

**TLV277x-EP, TLV277xA-EP**  
**FAMILY OF 2.7-V HIGH-SLEW-RATE RAIL-TO-RAIL OUTPUT**  
**OPERATIONAL AMPLIFIERS WITH SHUTDOWN**

SGLS317A – OCTOBER 2005 – REVISED SEPTEMBER 2007

**TYPICAL CHARACTERISTICS**



**Figure 51**

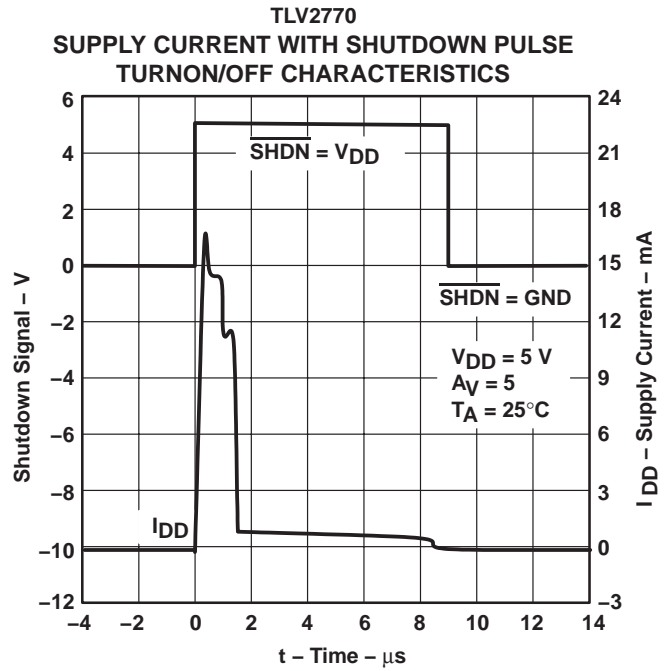

**Figure 52**

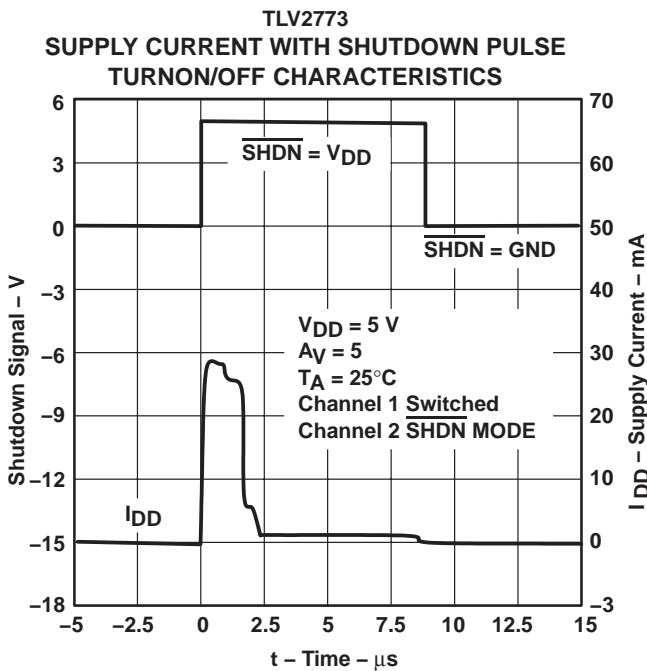

**Figure 53**

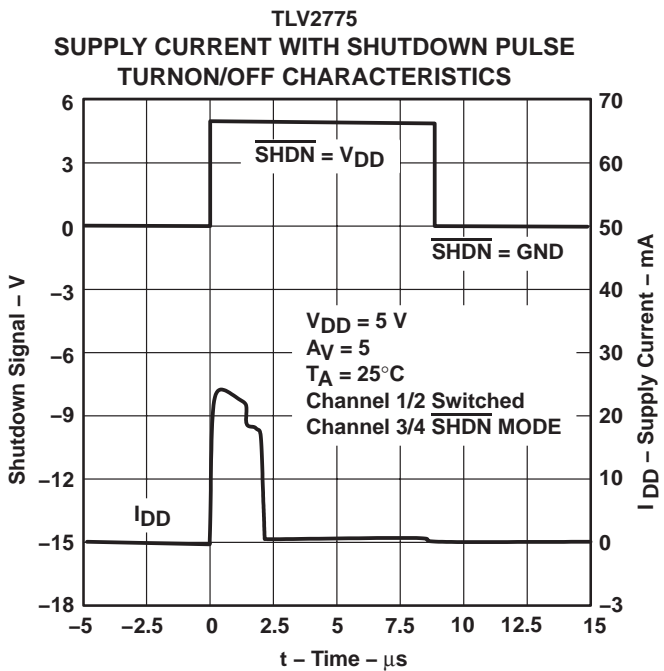

**Figure 54**



**TLV277x-EP, TLV277xA-EP**  
**FAMILY OF 2.7-V HIGH-SLEW-RATE RAIL-TO-RAIL OUTPUT**  
**OPERATIONAL AMPLIFIERS WITH SHUTDOWN**

SGLS317A – OCTOBER 2005 – REVISED SEPTEMBER 2007

**TYPICAL CHARACTERISTICS**

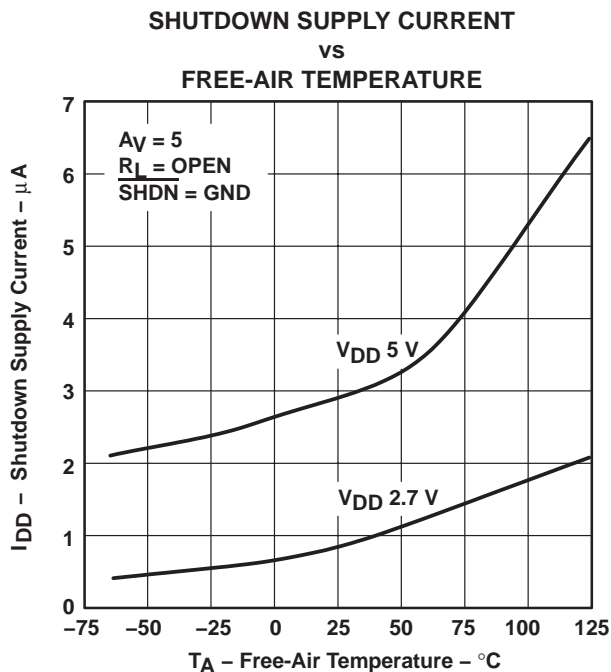

Figure 55

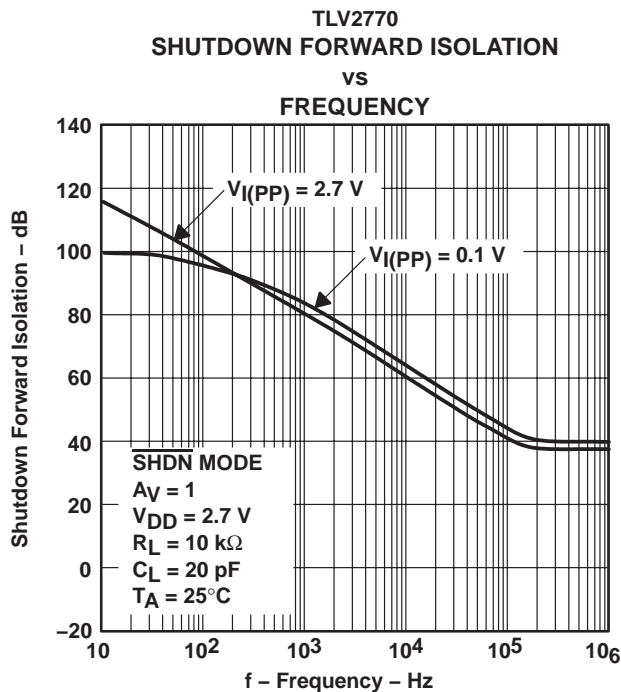

Figure 56

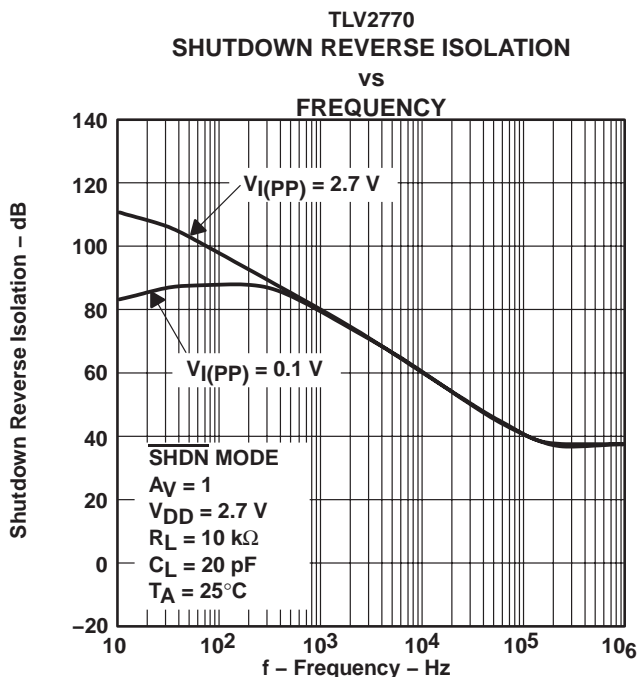

Figure 57

# TLV277x-EP, TLV277xA-EP FAMILY OF 2.7-V HIGH-SLEW-RATE RAIL-TO-RAIL OUTPUT OPERATIONAL AMPLIFIERS WITH SHUTDOWN

SGLS317A – OCTOBER 2005 – REVISED SEPTEMBER 2007

## PARAMETER MEASUREMENT INFORMATION

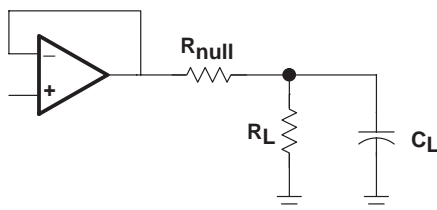

Figure 58

### driving a capacitive load

When the amplifier is configured in this manner, capacitive loading directly on the output will decrease the device's phase margin leading to high frequency ringing or oscillations. Therefore, for capacitive loads of greater than 10 pF, it is recommended that a resistor be placed in series ( $R_{NULL}$ ) with the output of the amplifier (See Figure 59). A minimum value of 20  $\Omega$  should work well for most applications.

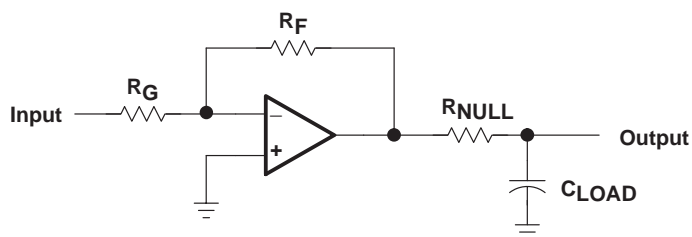
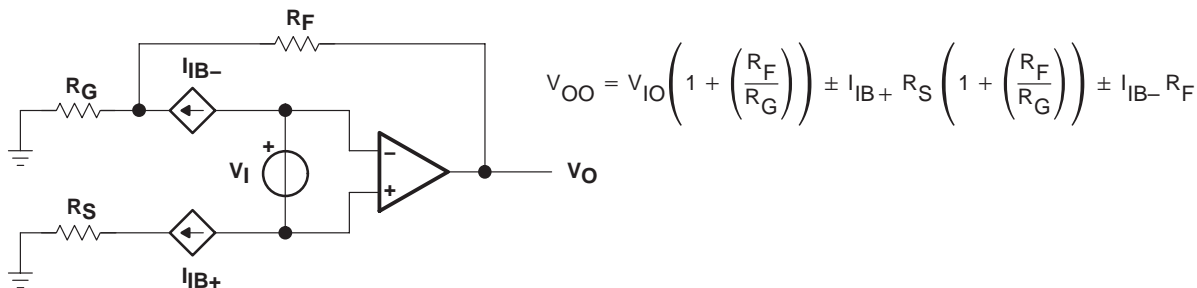

Figure 59. Driving a Capacitive Load

## APPLICATION INFORMATION

### offset voltage

The output offset voltage, ( $V_{OO}$ ) is the sum of the input offset voltage ( $V_{IO}$ ) and both input bias currents ( $I_{IB}$ ) times the corresponding gains. The following schematic and formula can be used to calculate the output offset voltage:



**Figure 60. Output Offset Voltage Model**

### general configurations

When receiving low-level signals, limiting the bandwidth of the incoming signals into the system is often required. The simplest way to accomplish this is to place an RC filter at the noninverting terminal of the amplifier (see Figure 61).

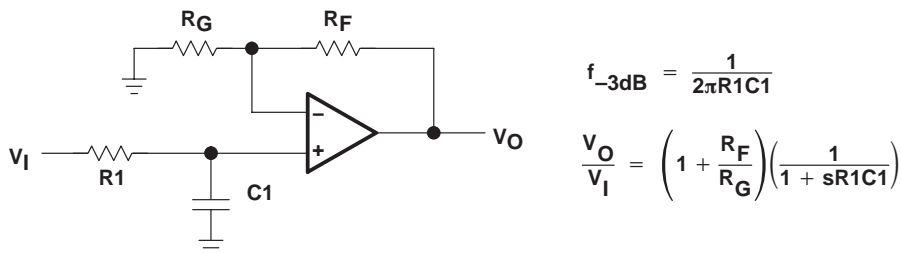

**Figure 61. Single-Pole Low-Pass Filter**

If even more attenuation is needed, a multiple pole filter is required. The Sallen-Key filter can be used for this task. For best results, the amplifier should have a bandwidth that is eight to ten times the filter frequency bandwidth. Failure to do this can result in phase shift of the amplifier.

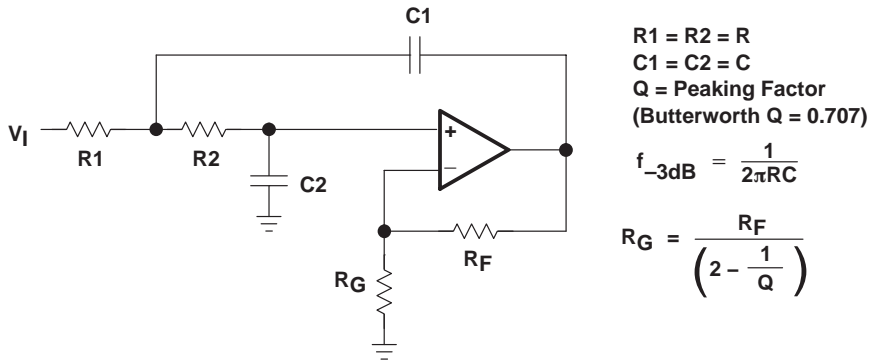

**Figure 62. Two Pole Low Pass Sallen Key Filter**

# TLV277x-EP, TLV277xA-EP FAMILY OF 2.7-V HIGH-SLEW-RATE RAIL-TO-RAIL OUTPUT OPERATIONAL AMPLIFIERS WITH SHUTDOWN

SGLS317A – OCTOBER 2005 – REVISED SEPTEMBER 2007

## APPLICATION INFORMATION

### using the TLV2772 as an accelerometer interface

The schematic (see Figure 63) shows the ACH04-08-05 interfaced to the TLV1544 10-bit analog-to-digital converter (ADC).

The ACH04-08-05 is a shock sensor designed to convert mechanical acceleration into electrical signals. The sensor contains three piezoelectric sensing elements oriented to simultaneously measure acceleration in three orthogonal, linear axes (x, y, z). The operating frequency is 0.5 Hz to 5 kHz. The output is buffered with an internal JFET and has a typical output voltage of 1.80 mV/g for the x and y axis and 1.35 mV/g for the z axis.

Amplification and frequency shaping of the shock sensor output is done by the TLV2772 rail-to-rail operational amplifier. The TLV2772 is ideal for this application as it offers high input impedance, good slew rate, and excellent dc precision. The rail-to-rail output swing and high output drive are perfect for driving the analog input of the TLV1544 ADC.

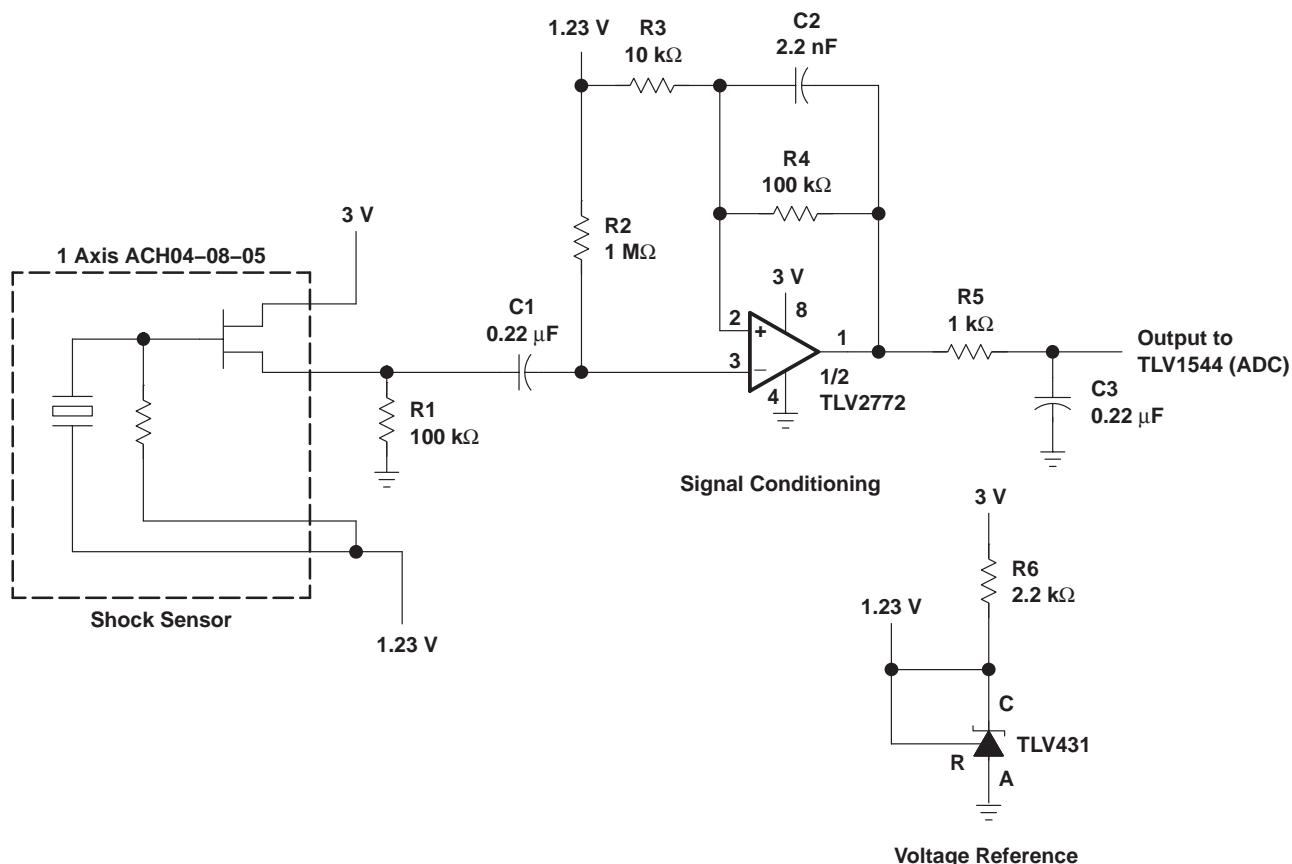

Figure 63. Accelerometer Interface Schematic

The sensor signal must be amplified and frequency-shaped to provide a signal the ADC can properly convert into the digital domain. Figure 63 shows the topology used in this application for one axis of the sensor. This system is powered from a single 3-V supply. Configuring the TLV431 with a 2.2-kΩ resistor produces a reference voltage of 1.23 V. This voltage is used to bias the operational amplifier and the internal JFETs in the shock sensor.

## APPLICATION INFORMATION

### gain calculation

Since the TLV2772 is capable of rail-to-rail output using a 3-V supply,  $V_O = 0$  (min) to 3 V (max). With no signal from the sensor, nominal  $V_O =$  reference voltage = 1.23 V. Therefore, the maximum negative swing from nominal is  $0\text{ V} - 1.23\text{ V} = -1.23\text{ V}$  and the maximum positive swing is  $3\text{ V} - 1.23\text{ V} = 1.77\text{ V}$ . By modeling the shock sensor as a low impedance voltage source with output of 2.25 mV/g (max) in the x and y axis and 1.70 mV/g (max) in the z axis, the gain of the circuit is calculated by equation 1.

$$\text{Gain} = \frac{\text{Output Swing}}{\text{Sensor Signal} \times \text{Acceleration}} \quad (1)$$

To avoid saturation of the operational amplifier, the gain calculations are based on the maximum negative swing of  $-1.23\text{ V}$  and the maximum sensor output of 2.25 mV/g (x and y axis) and 1.70 mV/g (z axis).

$$\text{Gain (x, y)} = \frac{-1.23\text{ V}}{2.25\text{ mV/g} \times -50\text{ g}} = 10.9 \quad (2)$$

and

$$\text{Gain (z)} = \frac{-1.23\text{ V}}{1.70\text{ mV/g} \times -50\text{ g}} = 14.5 \quad (3)$$

By selecting  $R_3 = 10\text{ k}\Omega$  and  $R_4 = 100\text{ k}\Omega$ , in the x and y channels, a gain of 11 is realized. By selecting  $R_3 = 7.5\text{ k}\Omega$  and  $R_4 = 100\text{ k}\Omega$ , in the z channel, a gain of 14.3 is realized. The schematic shows the configuration for either the x or y axis.

### bandwidth calculation

To calculate the component values for the frequency shaping characteristics of the signal conditioning circuit, 1 Hz and 500 Hz are selected as the minimum required 3-dB bandwidth.

To minimize the value of the input capacitor (C1) required to set the lower cutoff frequency requires a large value resistor for R2. A 1-M $\Omega$  resistor is used in this example. To set the lower cutoff frequency, the required capacitor value for C1 is:

$$C1 = \frac{1}{2\pi f_{\text{LOW}} R_2} = 0.159\text{ }\mu\text{F} \quad (4)$$

Using a value of 0.22  $\mu\text{F}$ , a more common value of capacitor, the lower cutoff frequency is 0.724 Hz.

To minimize the phase shift in the feedback loop caused by the input capacitance of the TLV2772, it is best to minimize the value of the feedback resistor R4. However, to reduce the required capacitance in the feedback loop a large value for R4 is required. Therefore, a compromise for the value of R4 must be made. In this circuit, a value of 100 k $\Omega$  has been selected. To set the upper cutoff frequency, the required capacitor value for C2 is:

$$C2 = \frac{1}{2\pi f_{\text{HIGH}} R_4} = 3.18\text{ }\mu\text{F} \quad (5)$$

Using a 2.2-nF capacitor, the upper cutoff frequency is 724 Hz.

R5 and C3 also cause the signal response to roll off. Therefore, it is beneficial to design this roll-off point to begin at the upper cutoff frequency. Assuming a value of 1 k $\Omega$  for R5, the value for C3 is calculated to be 0.22  $\mu\text{F}$ .

# TLV277x-EP, TLV277xA-EP FAMILY OF 2.7-V HIGH-SLEW-RATE RAIL-TO-RAIL OUTPUT OPERATIONAL AMPLIFIERS WITH SHUTDOWN

SGLS317A – OCTOBER 2005 – REVISED SEPTEMBER 2007

---

## APPLICATION INFORMATION

### circuit layout considerations

To achieve the levels of high performance of the TLV277x, follow proper printed-circuit board design techniques. A general set of guidelines is given in the following.

- Ground planes—It is highly recommended that a ground plane be used on the board to provide all components with a low inductive ground connection. However, in the areas of the amplifier inputs and output, the ground plane can be removed to minimize the stray capacitance.
- Proper power supply decoupling—Use a 6.8- $\mu$ F tantalum capacitor in parallel with a 0.1- $\mu$ F ceramic capacitor on each supply terminal. It may be possible to share the tantalum among several amplifiers depending on the application, but a 0.1- $\mu$ F ceramic capacitor should always be used on the supply terminal of every amplifier. In addition, the 0.1- $\mu$ F capacitor should be placed as close as possible to the supply terminal. As this distance increases, the inductance in the connecting trace makes the capacitor less effective. The designer should strive for distances of less than 0.1 inches between the device power terminals and the ceramic capacitors.
- Sockets—Sockets can be used but are not recommended. The additional lead inductance in the socket pins will often lead to stability problems. Surface-mount packages soldered directly to the printed-circuit board is the best implementation.
- Short trace runs/compact part placements—Optimum high performance is achieved when stray series inductance has been minimized. To realize this, the circuit layout should be made as compact as possible, thereby minimizing the length of all trace runs. Particular attention should be paid to the inverting input of the amplifier. Its length should be kept as short as possible. This minimizes stray capacitance at the input of the amplifier.
- Surface-mount passive components—Using surface-mount passive components is recommended for high performance amplifier circuits for several reasons. First, because of the extremely low lead inductance of surface-mount components, the problem with stray series inductance is greatly reduced. Second, the small size of surface-mount components naturally leads to a more compact layout thereby minimizing both stray inductance and capacitance. If leaded components are used, it is recommended that the lead lengths be kept as short as possible.

**APPLICATION INFORMATION**

**general power dissipation considerations**

For a given  $\theta_{JA}$ , the maximum power dissipation is shown in Figure 64 and is calculated by the following formula:

$$P_D = \left( \frac{T_{MAX} - T_A}{\theta_{JA}} \right)$$

Where:

- $P_D$  = Maximum power dissipation of TLV277x IC (watts)
- $T_{MAX}$  = Absolute maximum junction temperature (150°C)
- $T_A$  = Free-ambient air temperature (°C)
- $\theta_{JA}$  =  $\theta_{JC} + \theta_{CA}$
- $\theta_{JC}$  = Thermal coefficient from junction to case
- $\theta_{CA}$  = Thermal coefficient from case to ambient air (°C/W)

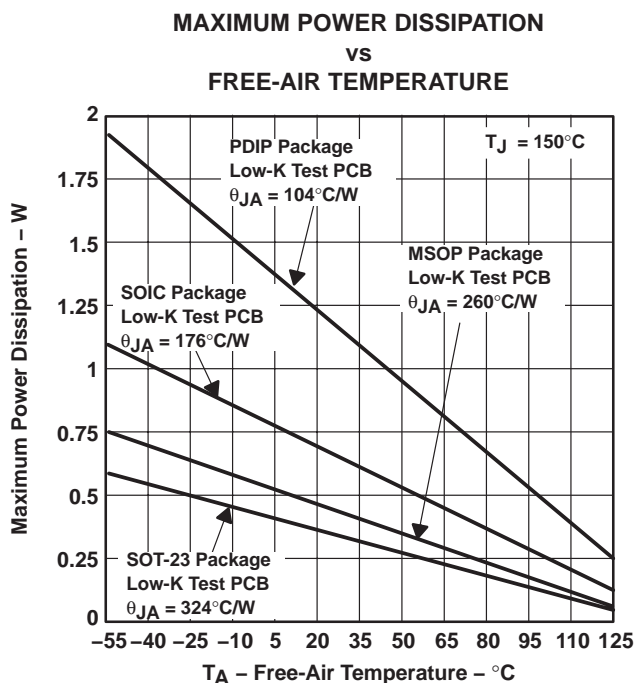

NOTE A: Results are with no air flow and using JEDEC Standard Low-K test PCB.

**Figure 64. Maximum Power Dissipation vs Free-Air Temperature**

# TLV277x-EP, TLV277xA-EP FAMILY OF 2.7-V HIGH-SLEW-RATE RAIL-TO-RAIL OUTPUT OPERATIONAL AMPLIFIERS WITH SHUTDOWN

SGLS317A – OCTOBER 2005 – REVISED SEPTEMBER 2007

---

## APPLICATION INFORMATION

### shutdown function

Three members of the TLV277x family (TLV2770/3/5) have a shutdown terminal for conserving battery life in portable applications. When the shutdown terminal is tied low, the supply current is reduced to  $0.8 \mu\text{A}/\text{channel}$ , the amplifier is disabled, and the outputs are placed in a high impedance mode. To enable the amplifier, the shutdown terminal can either be left floating or pulled high. When the shutdown terminal is left floating, care must be taken to ensure that parasitic leakage current at the shutdown terminal does not inadvertently place the operational amplifier into shutdown. The shutdown terminal threshold is always referenced to  $V_{DD}/2$ . Therefore, when operating the device with split supply voltages (e.g.  $\pm 2.5 \text{ V}$ ), the shutdown terminal must be pulled to  $V_{DD-}$  (not GND) to disable the operational amplifier.

The amplifier output with a shutdown pulse is shown in Figures 48, 49, and 50. The amplifier is powered with a single 5-V supply and configured as a noninverting configuration with a gain of 5. The amplifier turnon and turnoff times are measured from the 50% point of the shutdown pulse to the 50% point of the output waveform. The times for the single, dual, and quad are listed in the data tables. The bump on the rising edge of the TLV2770 output waveform is due to the start-up circuit on the bias generator. For the dual and quad (TLV2773/5), this bump is attributed to the bias generator's start-up circuit as well as the crosstalk between the other channel(s), which are in shutdown.

Figures 55 and 56 show the amplifier's forward and reverse isolation in shutdown. The operational amplifier is powered by  $\pm 1.35\text{-V}$  supplies and configured as a voltage follower ( $A_V = 1$ ). The isolation performance is plotted across frequency for both  $0.1 V_{PP}$  and  $2.7 V_{PP}$  input signals. During normal operation, the amplifier would not be able to handle a  $2.7\text{-V}_{PP}$  input signal with a supply voltage of  $\pm 1.35 \text{ V}$  since it exceeds the common-mode input voltage range ( $V_{ICR}$ ). However, this curve illustrates that the amplifier remains in shutdown even under a worst case scenario.





**PACKAGING INFORMATION**

Orderable Device	Status <sup>(1)</sup>	Package Type	Package Drawing	Pins	Package Qty	Eco Plan <sup>(2)</sup>	Lead/Ball Finish	MSL Peak Temp <sup>(3)</sup>
TLV2772AMDREP	ACTIVE	SOIC	D	8	2500	Green (RoHS & no Sb/Br)	CU NIPDAU	Level-1-260C-UNLIM
TLV2774AMDREP	ACTIVE	SOIC	D	14	2500	Green (RoHS & no Sb/Br)	CU NIPDAU	Level-1-260C-UNLIM
TLV2774MDREP	ACTIVE	SOIC	D	14	2500	Green (RoHS & no Sb/Br)	CU NIPDAU	Level-1-260C-UNLIM
V62/06607-02XE	ACTIVE	SOIC	D	8	2500	Green (RoHS & no Sb/Br)	CU NIPDAU	Level-1-260C-UNLIM
V62/06607-03YE	ACTIVE	SOIC	D	14	2500	Green (RoHS & no Sb/Br)	CU NIPDAU	Level-1-260C-UNLIM
V62/06607-04YE	ACTIVE	SOIC	D	14	2500	Green (RoHS & no Sb/Br)	CU NIPDAU	Level-1-260C-UNLIM

<sup>(1)</sup> The marketing status values are defined as follows:

**ACTIVE:** Product device recommended for new designs.

**LIFEBUY:** TI has announced that the device will be discontinued, and a lifetime-buy period is in effect.

**NRND:** Not recommended for new designs. Device is in production to support existing customers, but TI does not recommend using this part in a new design.

**PREVIEW:** Device has been announced but is not in production. Samples may or may not be available.

**OBSOLETE:** TI has discontinued the production of the device.

<sup>(2)</sup> Eco Plan - The planned eco-friendly classification: Pb-Free (RoHS), Pb-Free (RoHS Exempt), or Green (RoHS & no Sb/Br) - please check <http://www.ti.com/productcontent> for the latest availability information and additional product content details.

**TBD:** The Pb-Free/Green conversion plan has not been defined.

**Pb-Free (RoHS):** TI's terms "Lead-Free" or "Pb-Free" mean semiconductor products that are compatible with the current RoHS requirements for all 6 substances, including the requirement that lead not exceed 0.1% by weight in homogeneous materials. Where designed to be soldered at high temperatures, TI Pb-Free products are suitable for use in specified lead-free processes.

**Pb-Free (RoHS Exempt):** This component has a RoHS exemption for either 1) lead-based flip-chip solder bumps used between the die and package, or 2) lead-based die adhesive used between the die and leadframe. The component is otherwise considered Pb-Free (RoHS compatible) as defined above.

**Green (RoHS & no Sb/Br):** TI defines "Green" to mean Pb-Free (RoHS compatible), and free of Bromine (Br) and Antimony (Sb) based flame retardants (Br or Sb do not exceed 0.1% by weight in homogeneous material)

<sup>(3)</sup> MSL, Peak Temp. -- The Moisture Sensitivity Level rating according to the JEDEC industry standard classifications, and peak solder temperature.

**Important Information and Disclaimer:**The information provided on this page represents TI's knowledge and belief as of the date that it is provided. TI bases its knowledge and belief on information provided by third parties, and makes no representation or warranty as to the accuracy of such information. Efforts are underway to better integrate information from third parties. TI has taken and continues to take reasonable steps to provide representative and accurate information but may not have conducted destructive testing or chemical analysis on incoming materials and chemicals. TI and TI suppliers consider certain information to be proprietary, and thus CAS numbers and other limited information may not be available for release.

In no event shall TI's liability arising out of such information exceed the total purchase price of the TI part(s) at issue in this document sold by TI to Customer on an annual basis.

**OTHER QUALIFIED VERSIONS OF TLV2772A-EP, TLV2774-EP, TLV2774A-EP, TLV277X-EP, TLV277XA-EP :**

● Catalog: [TLV2772A](#), [TLV2774](#), [TLV2774A](#), [TLV277X](#), [TLV277XA](#)

● Automotive: [TLV2772A-Q1](#)

● Military: [TLV2772AM](#)

NOTE: Qualified Version Definitions:

● Catalog - TI's standard catalog product

● Automotive - Q100 devices qualified for high-reliability automotive applications targeting zero defects

● Military - QML certified for Military and Defense Applications

**TAPE AND REEL INFORMATION**



**QUADRANT ASSIGNMENTS FOR PIN 1 ORIENTATION IN TAPE**



\*All dimensions are nominal

Device	Package Type	Package Drawing	Pins	SPQ	Reel Diameter (mm)	Reel Width W1 (mm)	A0 (mm)	B0 (mm)	K0 (mm)	P1 (mm)	W (mm)	Pin1 Quadrant
TLV2772AMDREP	SOIC	D	8	2500	330.0	12.4	6.4	5.2	2.1	8.0	12.0	Q1
TLV2774AMDREP	SOIC	D	14	2500	330.0	16.4	6.5	9.0	2.1	8.0	16.0	Q1
TLV2774MDREP	SOIC	D	14	2500	330.0	16.4	6.5	9.0	2.1	8.0	16.0	Q1

**TAPE AND REEL BOX DIMENSIONS**

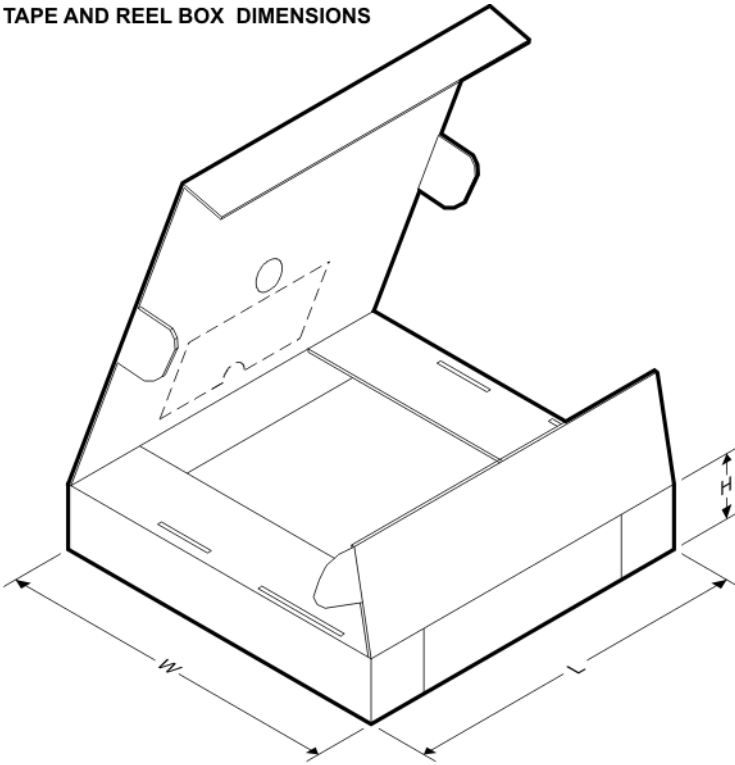

\*All dimensions are nominal

Device	Package Type	Package Drawing	Pins	SPQ	Length (mm)	Width (mm)	Height (mm)
TLV2772AMDREP	SOIC	D	8	2500	346.0	346.0	29.0
TLV2774AMDREP	SOIC	D	14	2500	333.2	345.9	28.6
TLV2774MDREP	SOIC	D	14	2500	333.2	345.9	28.6

D (R-PDSO-G14)

PLASTIC SMALL OUTLINE

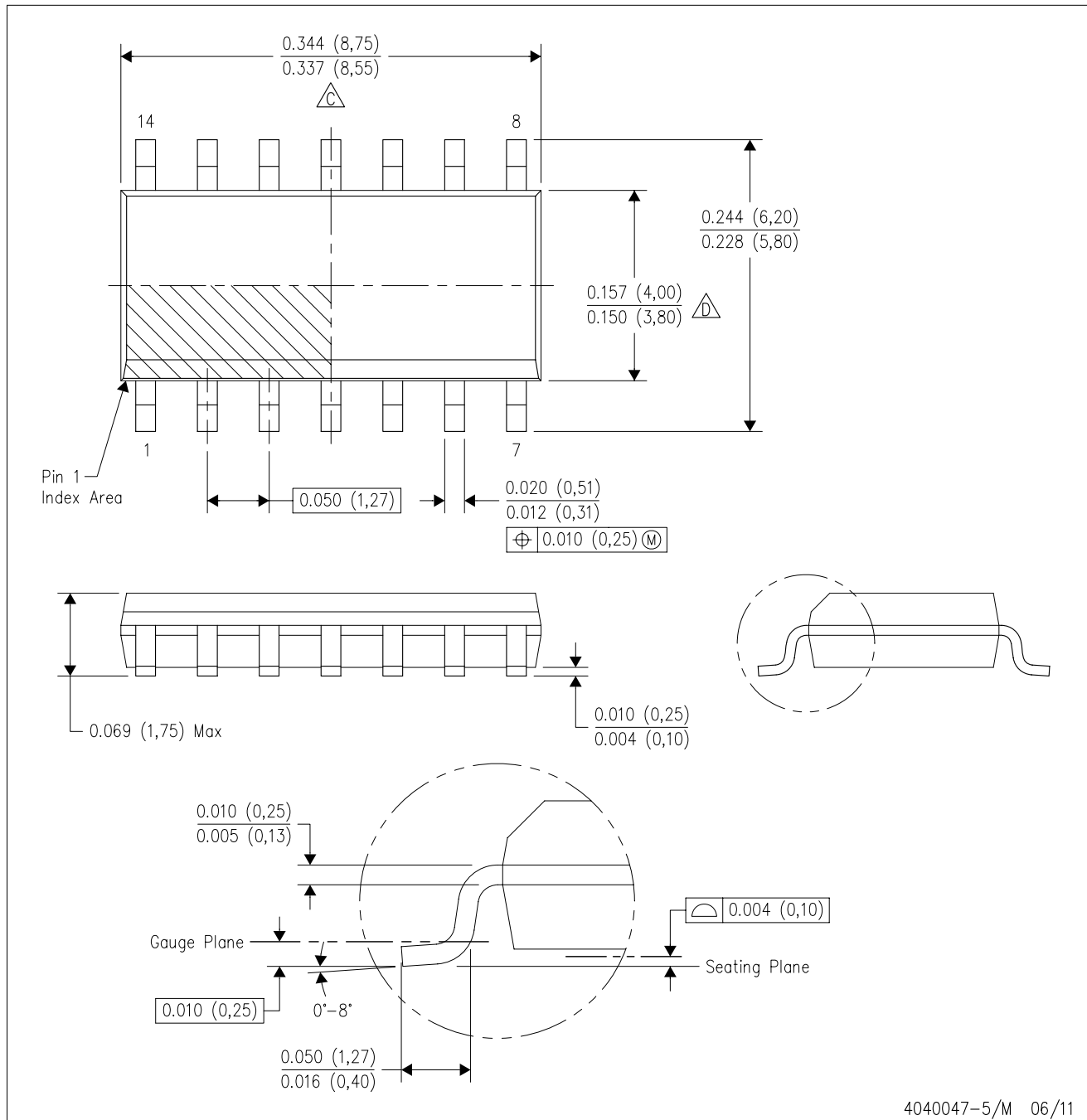

- NOTES:
- A. All linear dimensions are in inches (millimeters).
  - B. This drawing is subject to change without notice.
  - $\triangle C$  Body length does not include mold flash, protrusions, or gate burrs. Mold flash, protrusions, or gate burrs shall not exceed 0.006 (0,15) each side.
  - $\triangle D$  Body width does not include interlead flash. Interlead flash shall not exceed 0.017 (0,43) each side.
  - E. Reference JEDEC MS-012 variation AB.

D (R-PDSO-G8)

PLASTIC SMALL OUTLINE

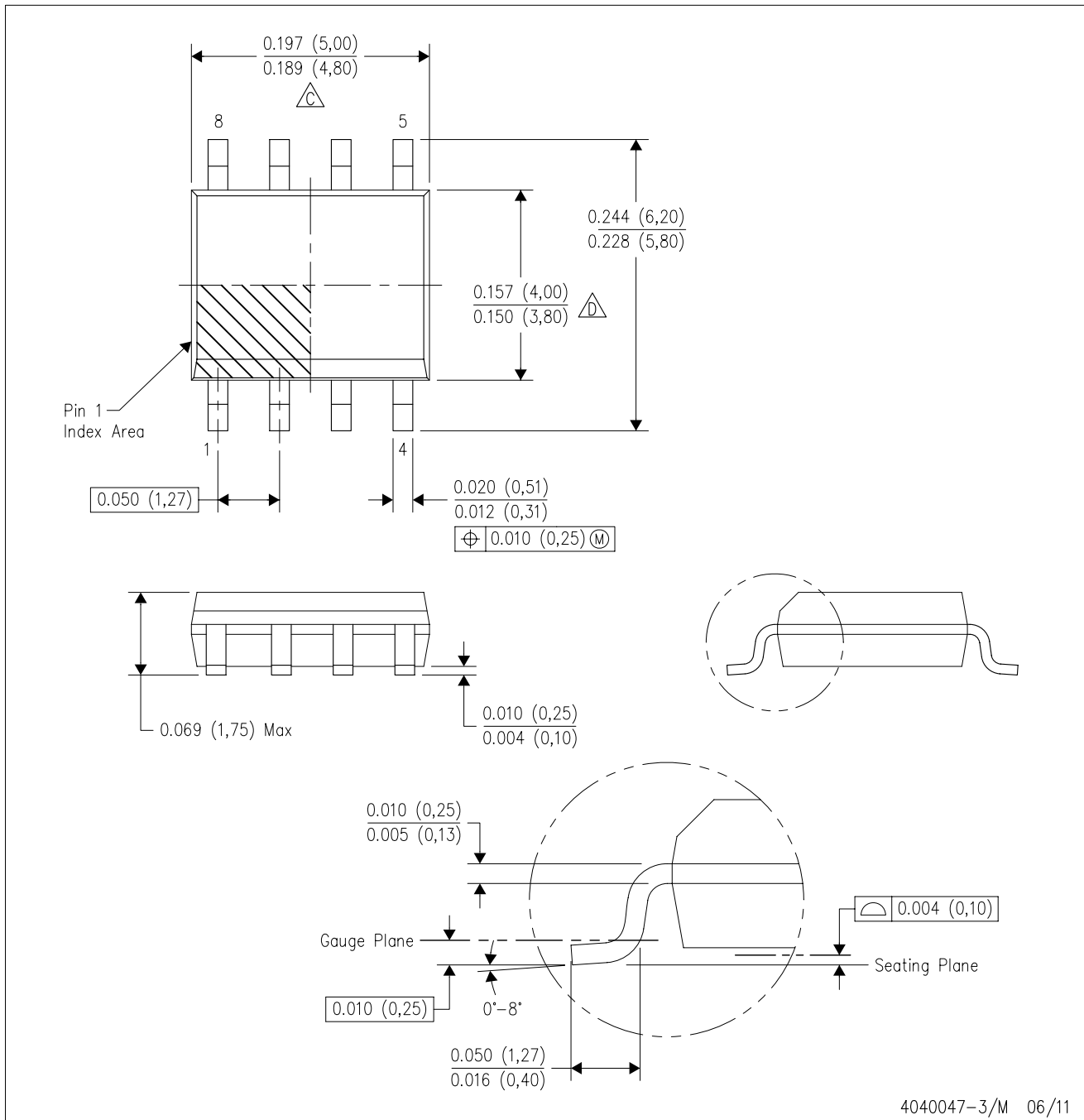

- NOTES:
- A. All linear dimensions are in inches (millimeters).
  - B. This drawing is subject to change without notice.
  - C. Body length does not include mold flash, protrusions, or gate burrs. Mold flash, protrusions, or gate burrs shall not exceed 0.006 (0,15) each side.
  - D. Body width does not include interlead flash. Interlead flash shall not exceed 0.017 (0,43) each side.
  - E. Reference JEDEC MS-012 variation AA.

D (R-PDSO-G8)

PLASTIC SMALL OUTLINE

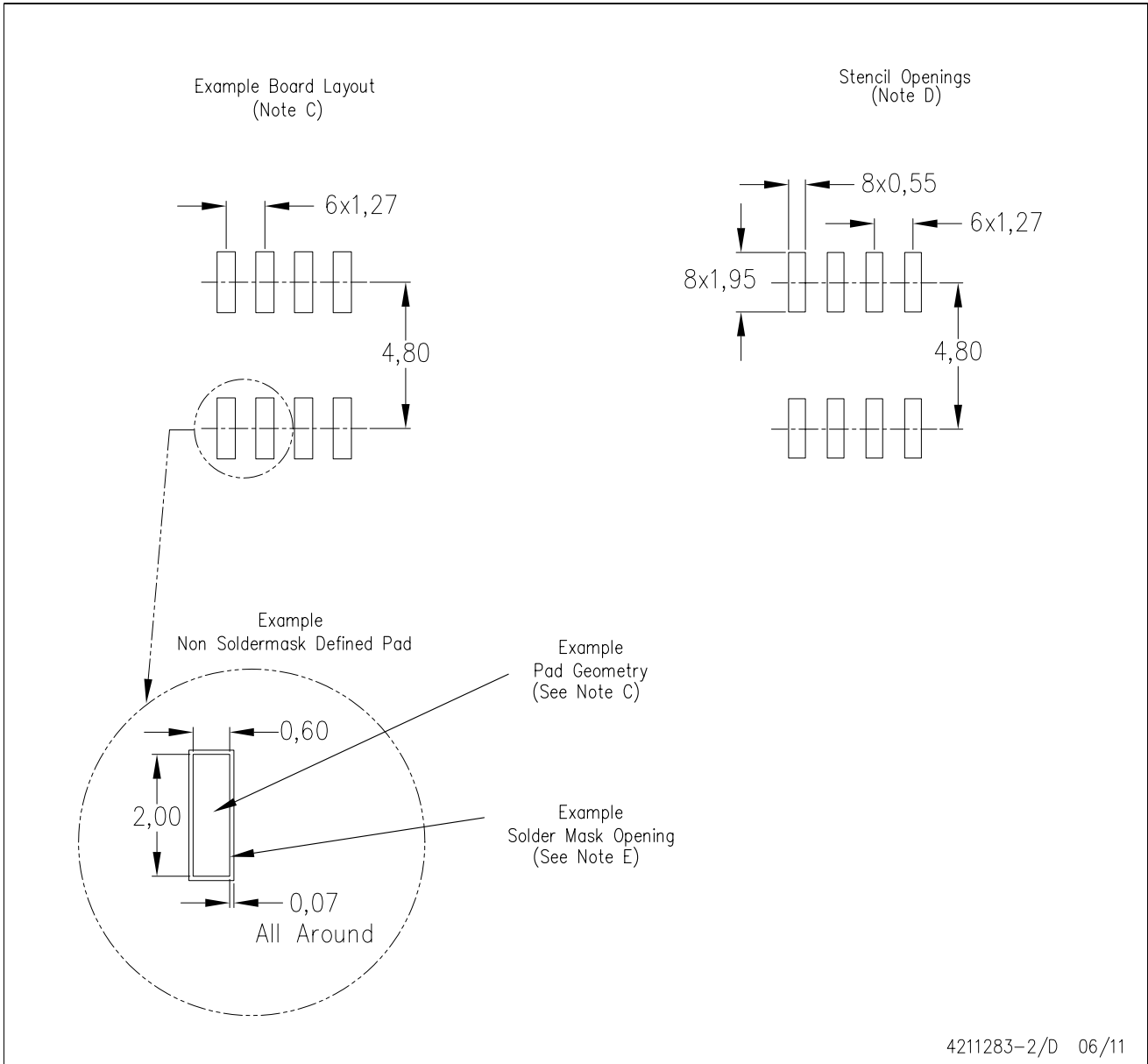

- NOTES:
- All linear dimensions are in millimeters.
  - This drawing is subject to change without notice.
  - Publication IPC-7351 is recommended for alternate designs.
  - Laser cutting apertures with trapezoidal walls and also rounding corners will offer better paste release. Customers should contact their board assembly site for stencil design recommendations. Refer to IPC-7525 for other stencil recommendations.
  - Customers should contact their board fabrication site for solder mask tolerances between and around signal pads.

## IMPORTANT NOTICE

Texas Instruments Incorporated and its subsidiaries (TI) reserve the right to make corrections, modifications, enhancements, improvements, and other changes to its products and services at any time and to discontinue any product or service without notice. Customers should obtain the latest relevant information before placing orders and should verify that such information is current and complete. All products are sold subject to TI's terms and conditions of sale supplied at the time of order acknowledgment.

TI warrants performance of its hardware products to the specifications applicable at the time of sale in accordance with TI's standard warranty. Testing and other quality control techniques are used to the extent TI deems necessary to support this warranty. Except where mandated by government requirements, testing of all parameters of each product is not necessarily performed.

TI assumes no liability for applications assistance or customer product design. Customers are responsible for their products and applications using TI components. To minimize the risks associated with customer products and applications, customers should provide adequate design and operating safeguards.

TI does not warrant or represent that any license, either express or implied, is granted under any TI patent right, copyright, mask work right, or other TI intellectual property right relating to any combination, machine, or process in which TI products or services are used. Information published by TI regarding third-party products or services does not constitute a license from TI to use such products or services or a warranty or endorsement thereof. Use of such information may require a license from a third party under the patents or other intellectual property of the third party, or a license from TI under the patents or other intellectual property of TI.

Reproduction of TI information in TI data books or data sheets is permissible only if reproduction is without alteration and is accompanied by all associated warranties, conditions, limitations, and notices. Reproduction of this information with alteration is an unfair and deceptive business practice. TI is not responsible or liable for such altered documentation. Information of third parties may be subject to additional restrictions.

Resale of TI products or services with statements different from or beyond the parameters stated by TI for that product or service voids all express and any implied warranties for the associated TI product or service and is an unfair and deceptive business practice. TI is not responsible or liable for any such statements.

TI products are not authorized for use in safety-critical applications (such as life support) where a failure of the TI product would reasonably be expected to cause severe personal injury or death, unless officers of the parties have executed an agreement specifically governing such use. Buyers represent that they have all necessary expertise in the safety and regulatory ramifications of their applications, and acknowledge and agree that they are solely responsible for all legal, regulatory and safety-related requirements concerning their products and any use of TI products in such safety-critical applications, notwithstanding any applications-related information or support that may be provided by TI. Further, Buyers must fully indemnify TI and its representatives against any damages arising out of the use of TI products in such safety-critical applications.

TI products are neither designed nor intended for use in military/aerospace applications or environments unless the TI products are specifically designated by TI as military-grade or "enhanced plastic." Only products designated by TI as military-grade meet military specifications. Buyers acknowledge and agree that any such use of TI products which TI has not designated as military-grade is solely at the Buyer's risk, and that they are solely responsible for compliance with all legal and regulatory requirements in connection with such use.

TI products are neither designed nor intended for use in automotive applications or environments unless the specific TI products are designated by TI as compliant with ISO/TS 16949 requirements. Buyers acknowledge and agree that, if they use any non-designated products in automotive applications, TI will not be responsible for any failure to meet such requirements.

Following are URLs where you can obtain information on other Texas Instruments products and application solutions:

### Products

Audio	<a href="http://www.ti.com/audio">www.ti.com/audio</a>
Amplifiers	<a href="http://amplifier.ti.com">amplifier.ti.com</a>
Data Converters	<a href="http://dataconverter.ti.com">dataconverter.ti.com</a>
DLP® Products	<a href="http://www.dlp.com">www.dlp.com</a>
DSP	<a href="http://dsp.ti.com">dsp.ti.com</a>
Clocks and Timers	<a href="http://www.ti.com/clocks">www.ti.com/clocks</a>
Interface	<a href="http://interface.ti.com">interface.ti.com</a>
Logic	<a href="http://logic.ti.com">logic.ti.com</a>
Power Mgmt	<a href="http://power.ti.com">power.ti.com</a>
Microcontrollers	<a href="http://microcontroller.ti.com">microcontroller.ti.com</a>
RFID	<a href="http://www.ti-rfid.com">www.ti-rfid.com</a>
RF/IF and ZigBee® Solutions	<a href="http://www.ti.com/lprf">www.ti.com/lprf</a>

### Applications

Communications and Telecom	<a href="http://www.ti.com/communications">www.ti.com/communications</a>
Computers and Peripherals	<a href="http://www.ti.com/computers">www.ti.com/computers</a>
Consumer Electronics	<a href="http://www.ti.com/consumer-apps">www.ti.com/consumer-apps</a>
Energy and Lighting	<a href="http://www.ti.com/energy">www.ti.com/energy</a>
Industrial	<a href="http://www.ti.com/industrial">www.ti.com/industrial</a>
Medical	<a href="http://www.ti.com/medical">www.ti.com/medical</a>
Security	<a href="http://www.ti.com/security">www.ti.com/security</a>
Space, Avionics and Defense	<a href="http://www.ti.com/space-avionics-defense">www.ti.com/space-avionics-defense</a>
Transportation and Automotive	<a href="http://www.ti.com/automotive">www.ti.com/automotive</a>
Video and Imaging	<a href="http://www.ti.com/video">www.ti.com/video</a>
Wireless	<a href="http://www.ti.com/wireless-apps">www.ti.com/wireless-apps</a>

TI E2E Community Home Page

[e2e.ti.com](http://e2e.ti.com)

Mailing Address: Texas Instruments, Post Office Box 655303, Dallas, Texas 75265  
Copyright © 2011, Texas Instruments Incorporated

[www.BDTIC.com/TI](http://www.BDTIC.com/TI)