

TPA311 350-mW MONO AUDIO POWER AMPLIFIER

SLOS207C – JANUARY 1998 – REVISED MAY 2003

- Fully Specified for 3.3-V and 5-V Operation
- Wide Power Supply Compatibility
2.5 V – 5.5 V
- Output Power for $R_L = 8 \Omega$
 - 350 mW at $V_{DD} = 5 \text{ V}$, BTL
 - 250 mW at $V_{DD} = 5 \text{ V}$, SE
 - 250 mW at $V_{DD} = 3.3 \text{ V}$, BTL
 - 75 mW at $V_{DD} = 3.3 \text{ V}$, SE
- Shutdown Control
 - $I_{DD} = 7 \mu\text{A}$ at 3.3 V
 - $I_{DD} = 60 \mu\text{A}$ at 5 V
- BTL to SE Mode Control
- Integrated Depop Circuitry
- Thermal and Short-Circuit Protection
- Surface Mount Packaging
 - SOIC
 - PowerPAD™ MSOP

description

The TPA311 is a bridge-tied load (BTL) or single-ended (SE) audio power amplifier developed especially for low-voltage applications where internal speakers and external earphone operation are required. Operating with a 3.3-V supply, the TPA311 can deliver 250-mW of continuous power into a BTL 8- Ω load at less than 1% THD+N throughout voice band frequencies. Although this device is characterized out to 20 kHz, its operation was optimized for narrower band applications such as cellular communications. The BTL configuration eliminates the need for external coupling capacitors on the output in most applications, which is particularly important for small battery-powered equipment. A unique feature of the TPA311 is that it allows the amplifier to switch from BTL to SE *on the fly* when an earphone drive is required. This eliminates complicated mechanical switching or auxiliary devices just to drive the external load. This device features a shutdown mode for power-sensitive applications with special depop circuitry to virtually eliminate speaker noise when exiting shutdown mode and during power cycling. The TPA311 is available in an 8-pin SOIC surface-mount package and the surface-mount PowerPAD MSOP, which reduces board space by 50% and height by 40%.

D OR DGN PACKAGE
(TOP VIEW)

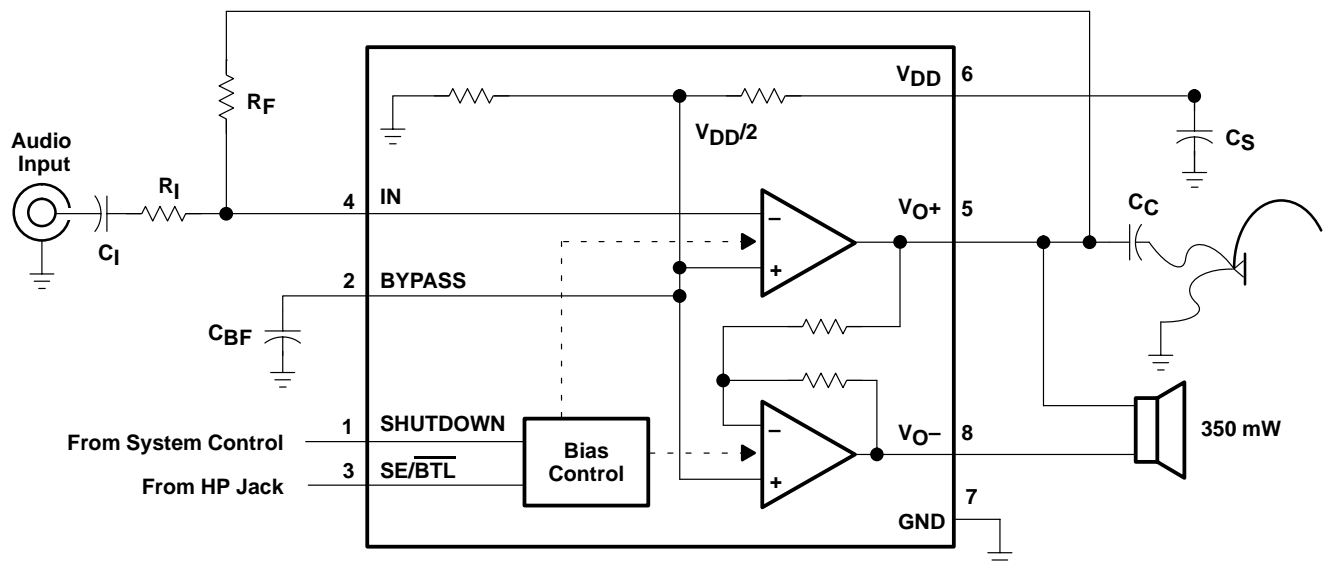
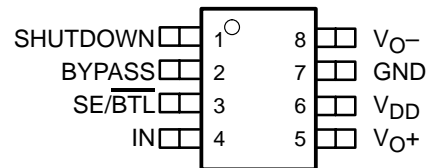

Please be aware that an important notice concerning availability, standard warranty, and use in critical applications of Texas Instruments semiconductor products and disclaimers thereto appears at the end of this data sheet.

PowerPAD is a trademark of Texas Instruments.

PRODUCTION DATA information is current as of publication date. Products conform to specifications per the terms of Texas Instruments standard warranty. Production processing does not necessarily include testing of all parameters.

Copyright © 1998 – 2003, Texas Instruments Incorporated

TEXAS INSTRUMENTS
www.BDITIC.com/TI

TPA311

350-mW MONO AUDIO POWER AMPLIFIER

SLOS207C – JANUARY 1998 – REVISED MAY 2003

AVAILABLE OPTIONS

T _A	PACKAGED DEVICES		MSOP Symbolization
	SMALL OUTLINE† (D)	MSOPT (DGN)	
–40°C to 85°C	TPA311D	TPA311DGN	AAB

† The D and DGN packages are available taped and reeled. To order a taped and reeled part, add the suffix R to the part number (e.g., TPA311DR).

Terminal Functions

TERMINAL NAME	NO.	I/O	DESCRIPTION
BYPASS	2	I	BYPASS is the tap to the voltage divider for internal mid-supply bias. This terminal should be connected to a 0.1-μF to 1-μF capacitor when used as an audio amplifier.
GND	7		GND is the ground connection.
IN	4	I	IN is the audio input terminal.
SE/BTL	3	I	When SE/BTL is held low, the TPA311 is in BTL mode. When SE/BTL is held high, the TPA311 is in SE mode.
SHUTDOWN	1	I	SHUTDOWN places the entire device in shutdown mode when held high (I _{DD} = 60 μA, V _{DD} = 5 V).
V _{DD}	6		V _{DD} is the supply voltage terminal.
V _{O+}	5	O	V _{O+} is the positive output for BTL and SE modes.
V _{O-}	8	O	V _{O-} is the negative output in BTL mode and a high-impedance output in SE mode.

absolute maximum ratings over operating free-air temperature range (unless otherwise noted)‡

Supply voltage, V _{DD}	6 V
Input voltage, V _I	–0.3 V to V _{DD} + 0.3 V
Continuous total power dissipation	internally limited (see Dissipation Rating Table)
Operating free-air temperature range, T _A (see Table 3)	–40°C to 85°C
Operating junction temperature range, T _J	–40°C to 150°C
Storage temperature range, T _{stg}	–65°C to 150°C
Lead temperature 1,6 mm (1/16 inch) from case for 10 seconds	260°C

‡ Stresses beyond those listed under “absolute maximum ratings” may cause permanent damage to the device. These are stress ratings only, and functional operation of the device at these or any other conditions beyond those indicated under “recommended operating conditions” is not implied. Exposure to absolute-maximum-rated conditions for extended periods may affect device reliability.

DISSIPATION RATING TABLE

PACKAGE	T _A ≤ 25°C	DERATING FACTOR	T _A = 70°C	T _A = 85°C
D	725 mW	5.8 mW/°C	464 mW	377 mW
DGN	2.14 W§	17.1 mW/°C	1.37 W	1.11 W

§ Please see the Texas Instruments document, *PowerPAD Thermally Enhanced Package Application Report* (literature number SLMA002), for more information on the PowerPAD package. The thermal data was measured on a PCB layout based on the information in the section entitled *Texas Instruments Recommended Board for PowerPAD* on page 33 of the before mentioned document.



www.ti.com

POST OFFICE BOX 655303 • DALLAS, TEXAS 75263

recommended operating conditions

		MIN	MAX	UNIT
Supply voltage, V_{DD}		2.5	5.5	V
High-level voltage, V_{IH}	SHUTDOWN	$0.9 V_{DD}$		V
	$\overline{SE/BTL}$	$0.9 V_{DD}$		
Low-level voltage, V_{IL}	SHUTDOWN	$0.1 V_{DD}$		V
	$\overline{SE/BTL}$	$0.1 V_{DD}$		
Operating free-air temperature, T_A (see Table 3)		-40	85	°C

electrical characteristics at specified free-air temperature, $V_{DD} = 3.3$ V, $T_A = 25^\circ\text{C}$ (unless otherwise noted)

PARAMETER	TEST CONDITIONS	MIN	TYP	MAX	UNIT
$ V_{OO} $ Output offset voltage (measured differentially)	SHUTDOWN = 0 V, $\overline{SE/BTL} = 0$ V, $R_L = 8 \Omega$, $R_F = 10 \text{ k}\Omega$		5	20	mV
PSRR Power supply rejection ratio	$V_{DD} = 3.2$ V to 3.4 V	BTL mode	85		dB
		SE mode	83		
I_{DD} Supply current (see Figure 6)	SHUTDOWN = 0 V, $\overline{SE/BTL} = 0.33$ V, $R_F = 10 \text{ k}\Omega$	BTL mode	0.7	1.5	mA
	SHUTDOWN = 0 V, $\overline{SE/BTL} = 2.97$ V, $R_F = 10 \text{ k}\Omega$	SE mode	0.35	0.75	
$I_{DD(SD)}$ Supply current, shutdown mode (see Figure 7)	SHUTDOWN = V_{DD} , $\overline{SE/BTL} = 0$ V, $R_F = 10 \text{ k}\Omega$		7	50	μA
$ I_{IH} $ High-level input current	SHUTDOWN, $V_{DD} = 3.3$ V, $V_I = V_{DD}$			1	μA
	$\overline{SE/BTL}$, $V_{DD} = 3.3$ V, $V_I = V_{DD}$			1	
$ I_{IL} $ Low-level input current	SHUTDOWN, $V_{DD} = 3.3$ V, $V_I = 0$ V			1	μA
	$\overline{SE/BTL}$, $V_{DD} = 3.3$ V, $V_I = 0$ V			1	

operating characteristics, $V_{DD} = 3.3$ V, $T_A = 25^\circ\text{C}$, $R_L = 8 \Omega$

PARAMETER	TEST CONDITIONS	MIN	TYP	MAX	UNIT
P_O Output power, see Note 1	THD = 0.5%, BTL mode, See Figure 14		250		mW
	THD = 0.5%, SE mode		110		
THD + N Total harmonic distortion plus noise	$P_O = 250$ mW, $f = 20$ Hz to 4 kHz, $A_V = -2$ V/V, See Figure 12		1.3%		
B_{OM} Maximum output power bandwidth	$A_V = -2$ V/V, THD = 3%, See Figure 12		10		kHz
B_1 Unity-gain bandwidth	Open loop, See Figure 36		1.4		MHz
Supply ripple rejection ratio	$f = 1$ kHz, $C_B = 1 \mu\text{F}$, BTL mode, See Figure 5		71		dB
	$f = 1$ kHz, $C_B = 1 \mu\text{F}$, SE mode, See Figure 3		86		
V_n Noise output voltage	$A_V = -1$ V/V, BTL, $C_B = 0.1 \mu\text{F}$, $R_L = 32 \Omega$, See Figure 42		15		$\mu\text{V(rms)}$

NOTE 1: Output power is measured at the output terminals of the device at $f = 1$ kHz.

TPA311

350-mW MONO AUDIO POWER AMPLIFIER

SLOS207C – JANUARY 1998 – REVISED MAY 2003

electrical characteristics at specified free-air temperature, $V_{DD} = 5\text{ V}$, $T_A = 25^\circ\text{C}$ (unless otherwise noted)

PARAMETER		TEST CONDITIONS	MIN	TYP	MAX	UNIT
$ V_{OO} $	Output offset voltage (measured differentially)	SHUTDOWN = 0 V, SE/BTL = 0 V, $R_L = 8\ \Omega$, $R_F = 10\ \text{k}\Omega$		5	20	mV
PSRR	Power supply rejection ratio	$V_{DD} = 4.9\text{ V to } 5.1\text{ V}$	BTL mode	78		dB
			SE mode	76		
I_{DD}	Supply current (see Figure 6)	SHUTDOWN = 0 V, SE/BTL = 0.5 V, $R_F = 10\ \text{k}\Omega$	BTL mode	0.7	1.5	mA
		SHUTDOWN = 0 V, SE/BTL = 4.5 V, $R_F = 10\ \Omega$	SE mode	0.35	0.75	
$I_{DD(SD)}$	Supply current, shutdown mode (see Figure 7)	SHUTDOWN = V_{DD} , SE/BTL = 0 V, $R_F = 10\ \text{k}\Omega$		60	100	μA
$ I_{IH} $	High-level input current	SHUTDOWN, $V_{DD} = 5.5\text{ V}$, $V_I = V_{DD}$			1	μA
		SE/BTL, $V_{DD} = 5.5\text{ V}$, $V_I = V_{DD}$			1	
$ I_{IL} $	Low-level input current	SHUTDOWN, $V_{DD} = 5.5\text{ V}$, $V_I = 0\text{ V}$			1	μA
		SE/BTL, $V_{DD} = 5.5\text{ V}$, $V_I = 0\text{ V}$			1	

operating characteristics, $V_{DD} = 5\text{ V}$, $T_A = 25^\circ\text{C}$, $R_L = 8\ \Omega$

PARAMETER		TEST CONDITIONS	MIN	TYP	MAX	UNIT
P_O	Output power, see Note 2	THD = 0.5%, BTL mode, See Figure 18		700		mW
		THD = 0.5%, SE mode		300		
THD + N	Total harmonic distortion plus noise	$P_O = 350\text{ mW}$, $f = 20\text{ Hz to } 4\text{ kHz}$, $A_V = -2\text{ V/V}$, See Figure 16		1%		
B _{OM}	Maximum output power bandwidth	$A_V = -2\text{ V/V}$, THD = 2%, See Figure 16		10		kHz
B ₁	Unity-gain bandwidth	Open loop, See Figure 37		1.4		MHz
	Supply ripple rejection ratio	$f = 1\text{ kHz}$, $C_B = 1\ \mu\text{F}$, BTL mode, See Figure 5		65		dB
		$f = 1\text{ kHz}$, $C_B = 1\ \mu\text{F}$, SE mode, See Figure 4		75		
V_n	Noise output voltage	$A_V = -1\text{ V/V}$, BTL, $C_B = 0.1\ \mu\text{F}$, $R_L = 32\ \Omega$, See Figure 43		15		$\mu\text{V(rms)}$

NOTE 2: Output power is measured at the output terminals of the device at $f = 1\text{ kHz}$.

PARAMETER MEASUREMENT INFORMATION

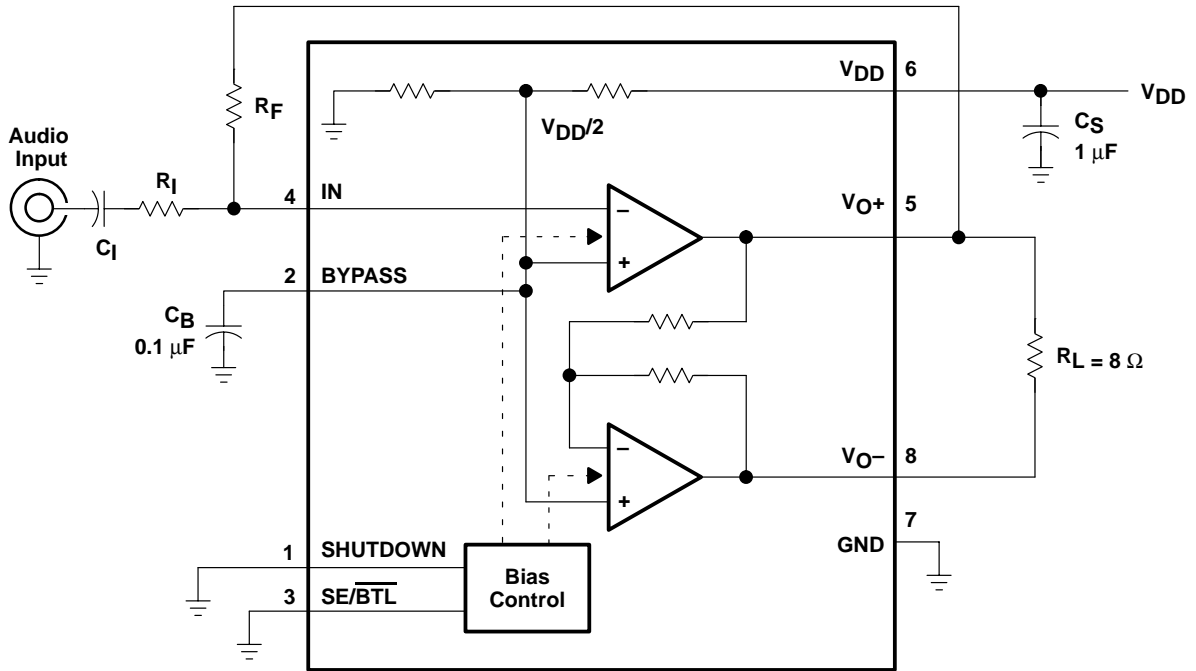

Figure 1. BTL Mode Test Circuit

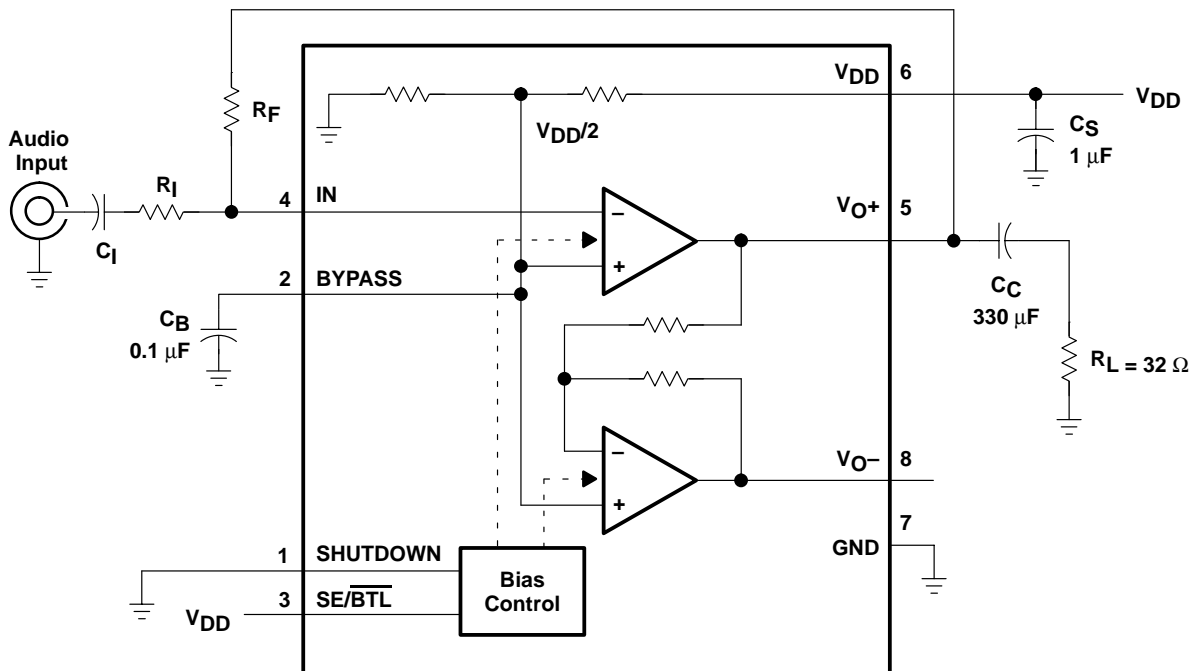

Figure 2. SE Mode Test Circuit

TPA311

350-mW MONO AUDIO POWER AMPLIFIER

SLOS207C – JANUARY 1998 – REVISED MAY 2003

TYPICAL CHARACTERISTICS

Table of Graphs

		FIGURE
Supply voltage rejection ratio	vs Frequency	3, 4, 5
I_{DD} Supply current	vs Supply voltage	6, 7
P_O Output power	vs Supply voltage	8, 9
	vs Load resistance	10, 11
THD+N Total harmonic distortion plus noise	vs Frequency	12, 13, 16, 17, 20, 21, 24, 25, 28, 29, 32, 33
	vs Output power	14, 15, 18, 19, 22, 23, 26, 27, 30, 31, 34, 35
Open loop gain and phase	vs Frequency	36, 37
Closed loop gain and phase	vs Frequency	38, 39, 40, 41
V_n Output noise voltage	vs Frequency	42, 43
P_D Power dissipation	vs Output power	44, 45, 46, 47

SUPPLY VOLTAGE REJECTION RATIO
VS
FREQUENCY

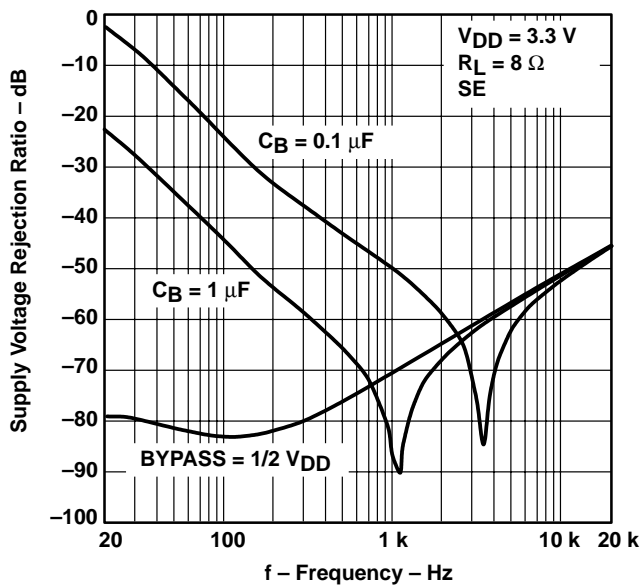

Figure 3

SUPPLY VOLTAGE REJECTION RATIO
VS
FREQUENCY

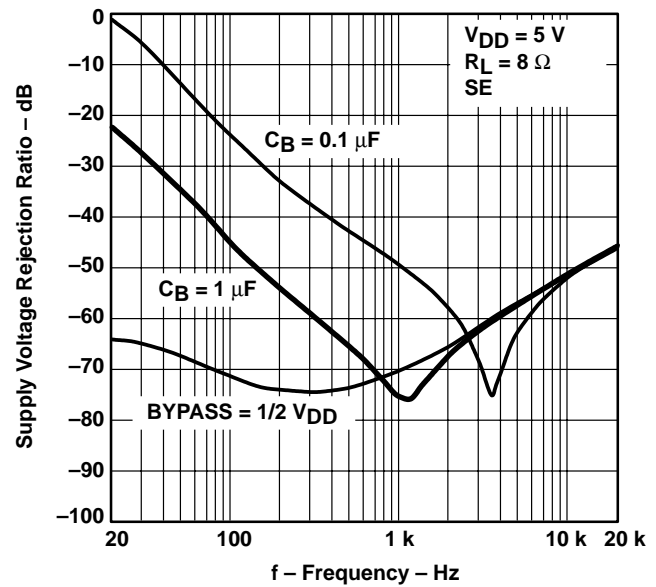

Figure 4



TYPICAL CHARACTERISTICS

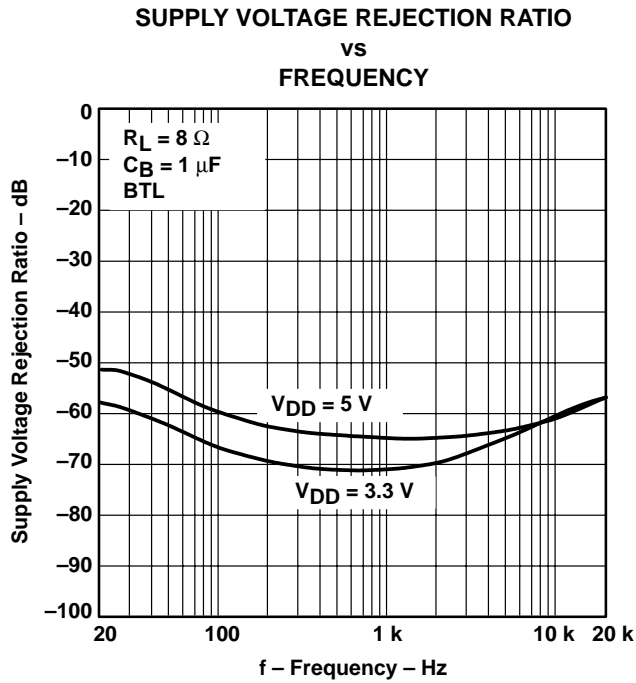

Figure 5

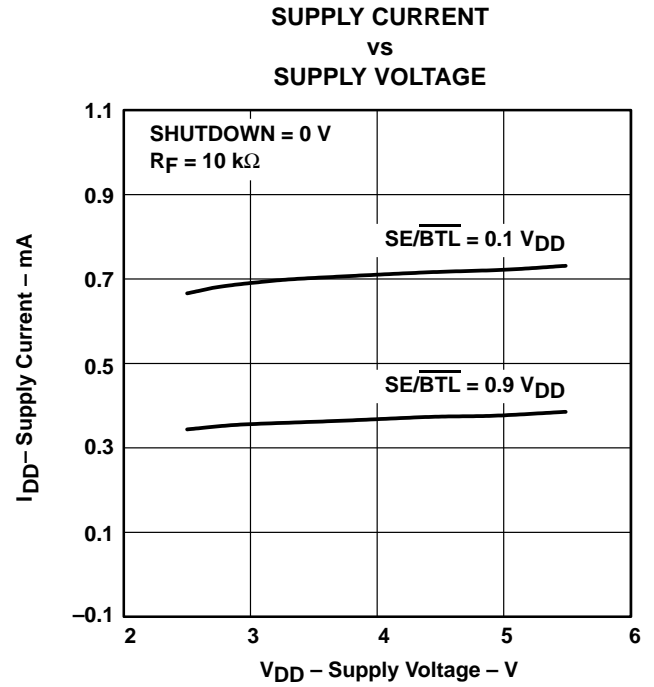

Figure 6

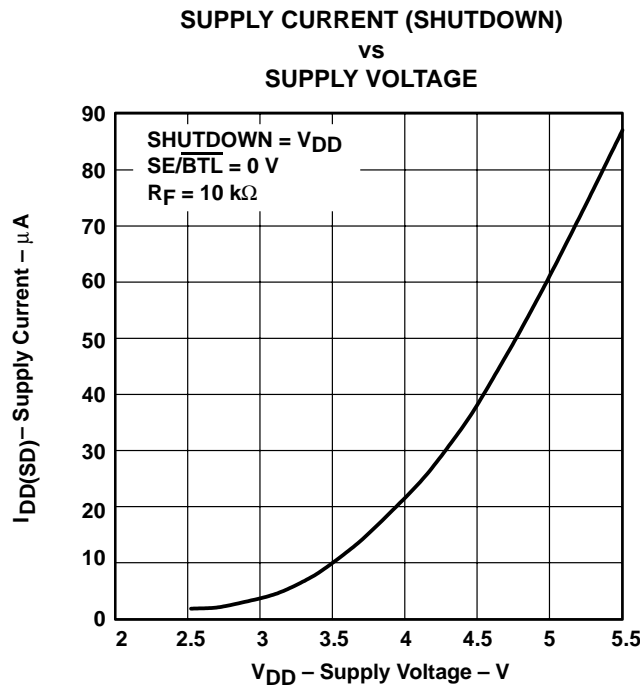

Figure 7

TPA311 350-mW MONO AUDIO POWER AMPLIFIER

SLOS207C – JANUARY 1998 – REVISED MAY 2003

TYPICAL CHARACTERISTICS

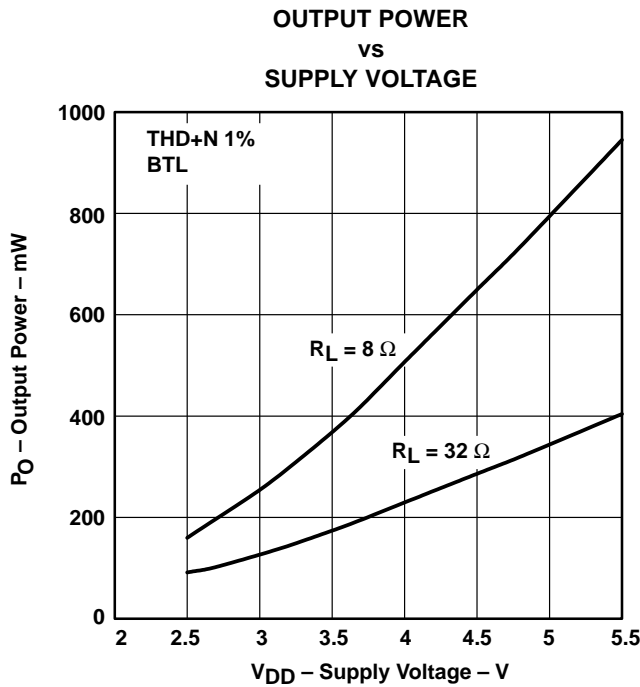

Figure 8

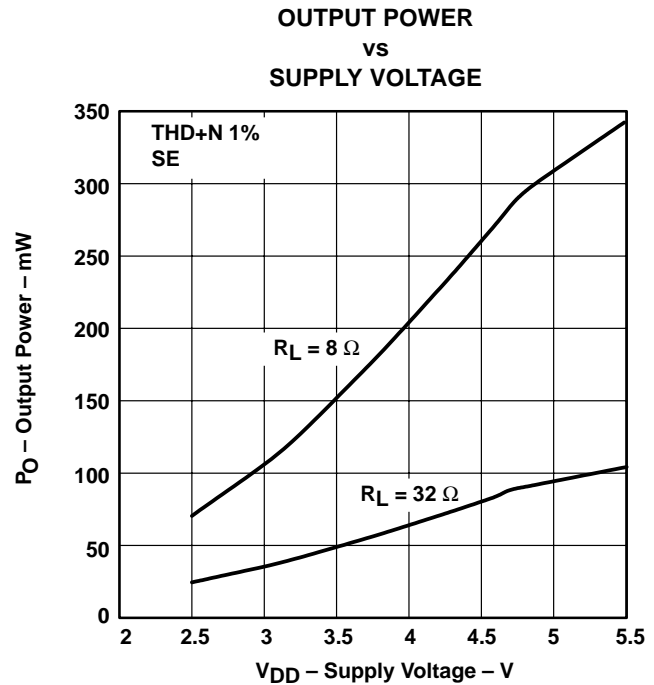

Figure 9

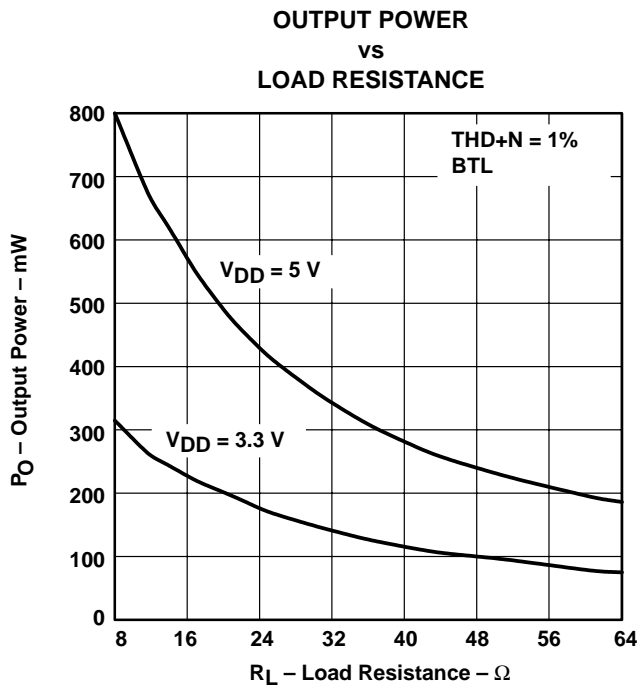

Figure 10

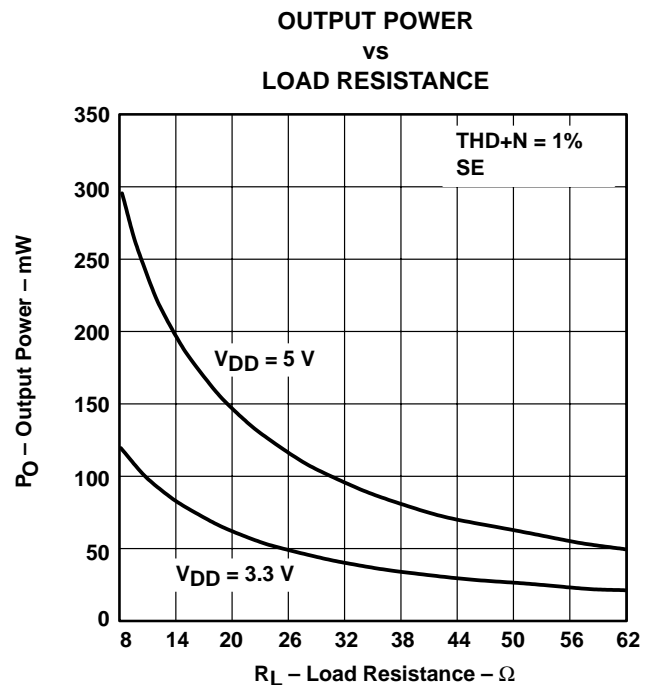

Figure 11



TYPICAL CHARACTERISTICS

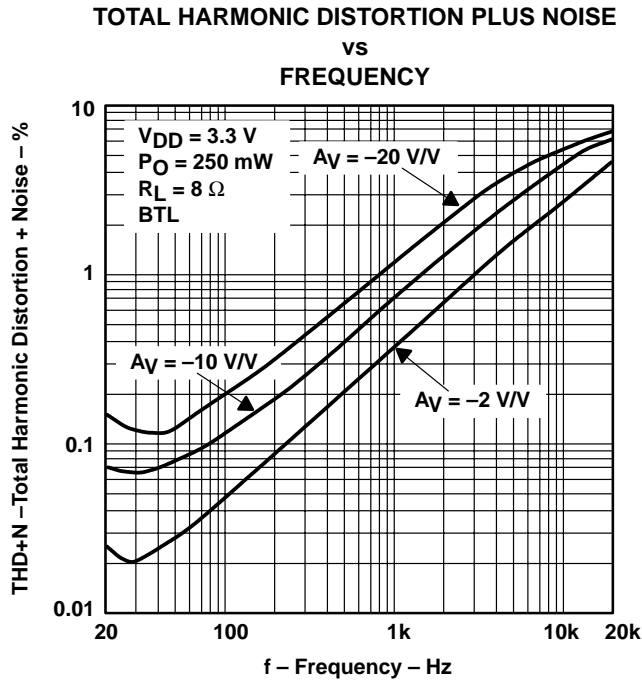

Figure 12

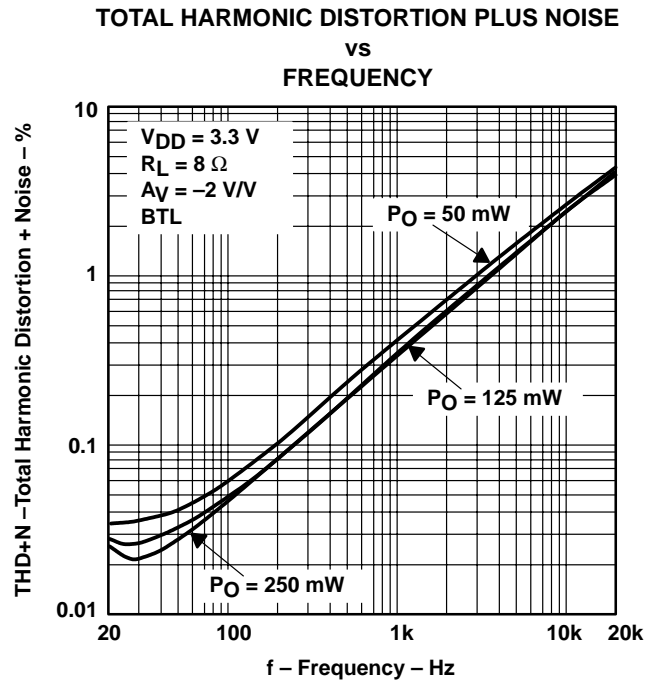

Figure 13

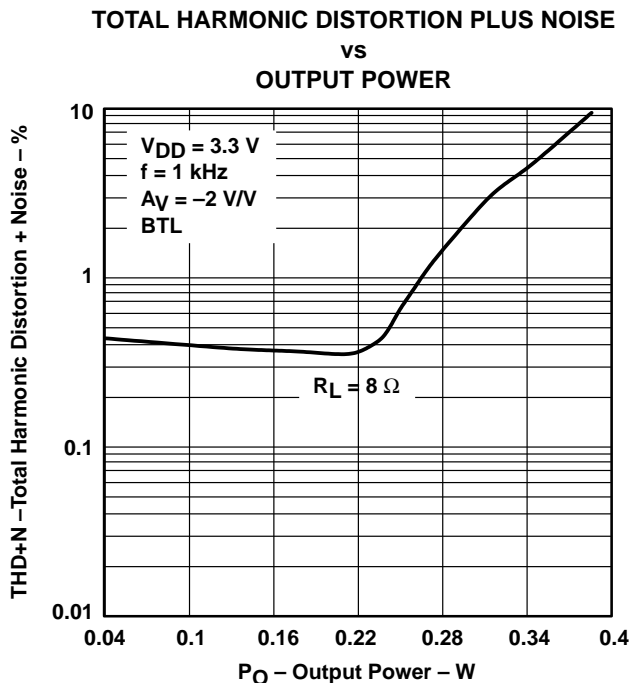

Figure 14

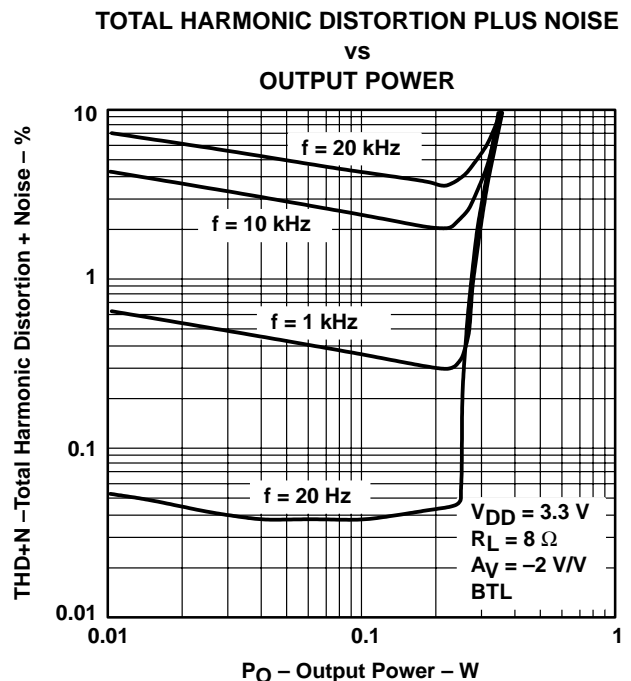

Figure 15

TPA311 350-mW MONO AUDIO POWER AMPLIFIER

SLOS207C – JANUARY 1998 – REVISED MAY 2003

TYPICAL CHARACTERISTICS

TOTAL HARMONIC DISTORTION PLUS NOISE
VS
FREQUENCY

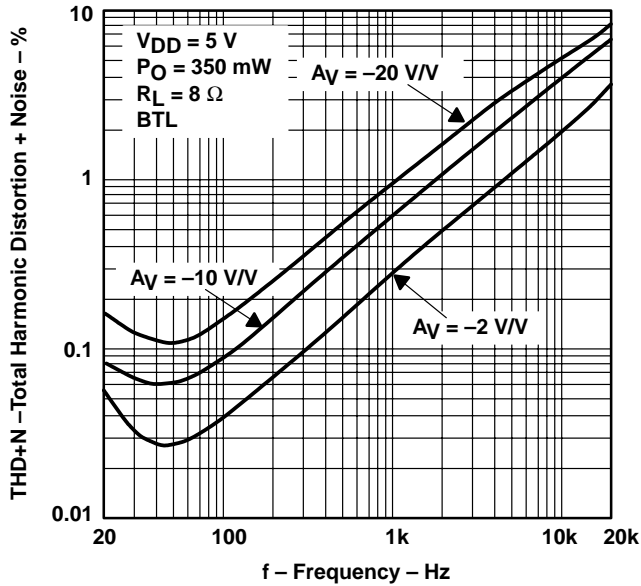

Figure 16

TOTAL HARMONIC DISTORTION PLUS NOISE
VS
FREQUENCY

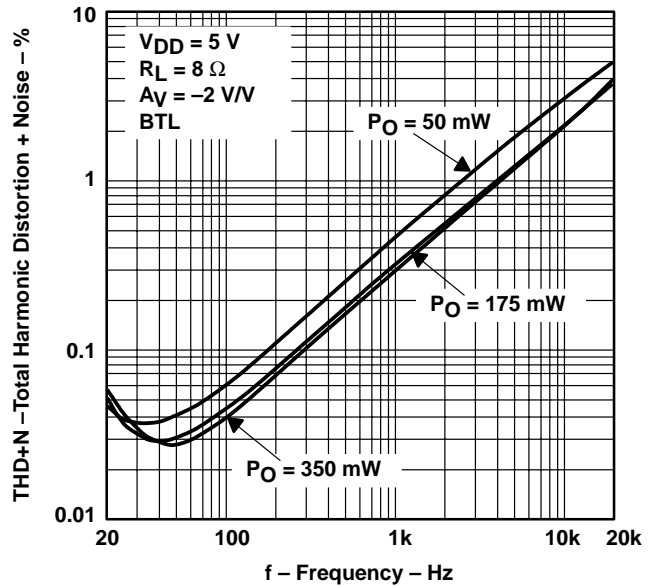

Figure 17

TOTAL HARMONIC DISTORTION PLUS NOISE
VS
OUTPUT POWER

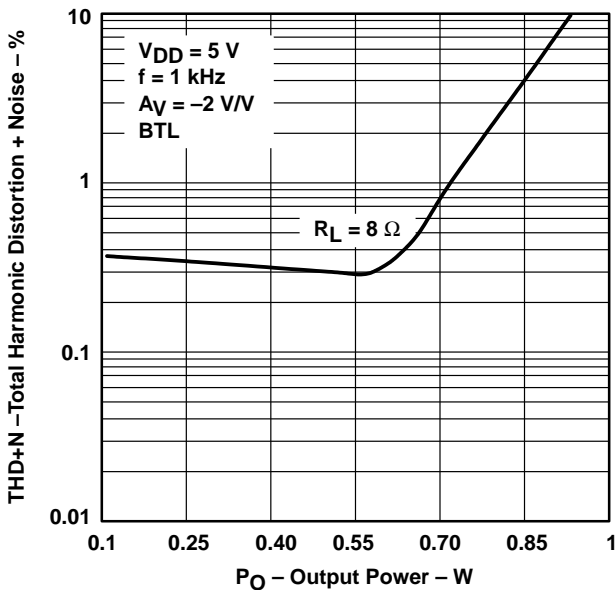

Figure 18

TOTAL HARMONIC DISTORTION PLUS NOISE
VS
OUTPUT POWER

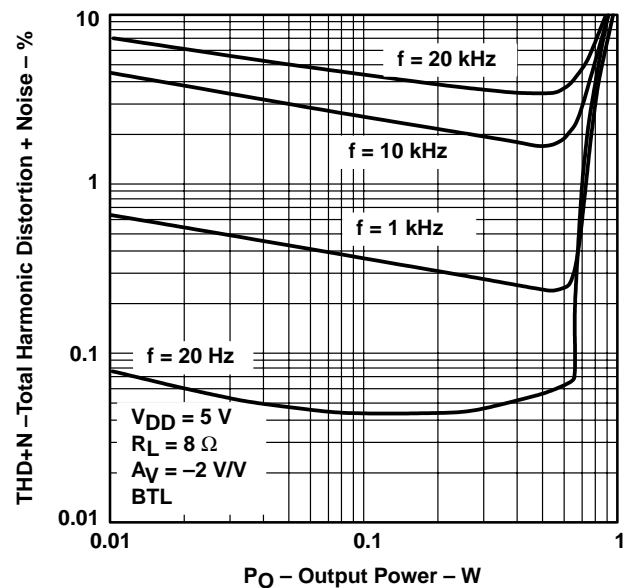

Figure 19



TYPICAL CHARACTERISTICS

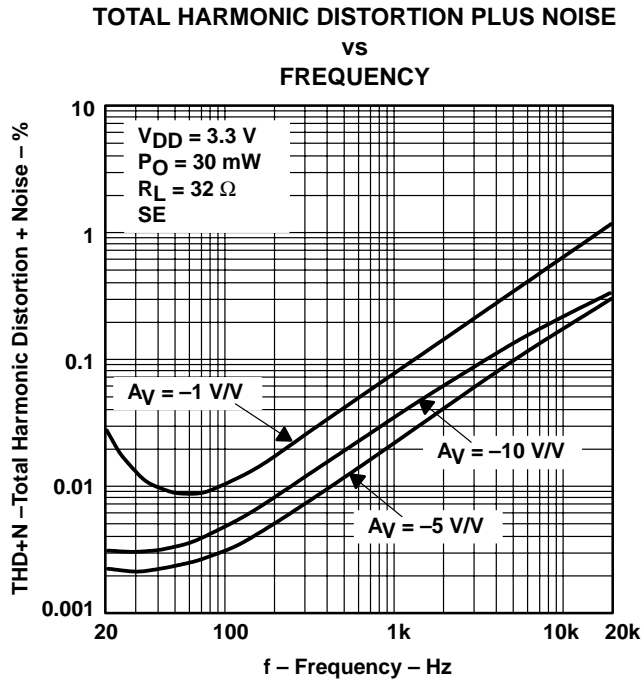

Figure 20

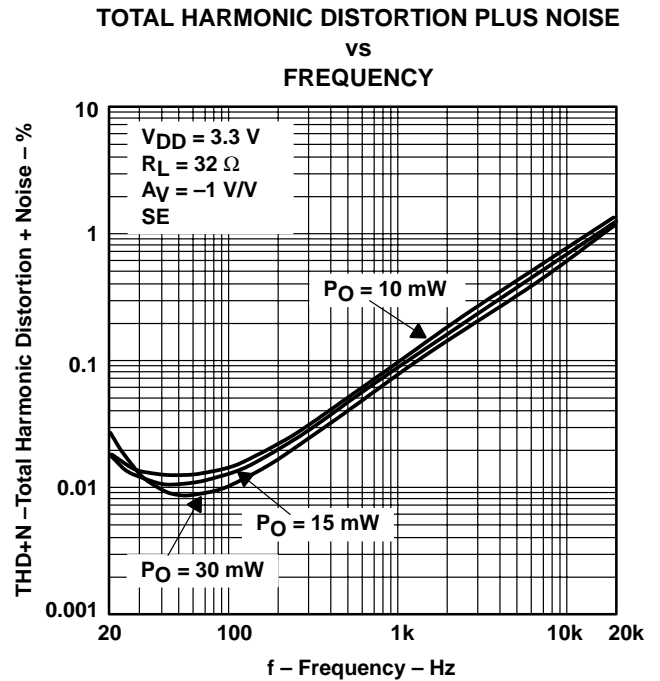

Figure 21

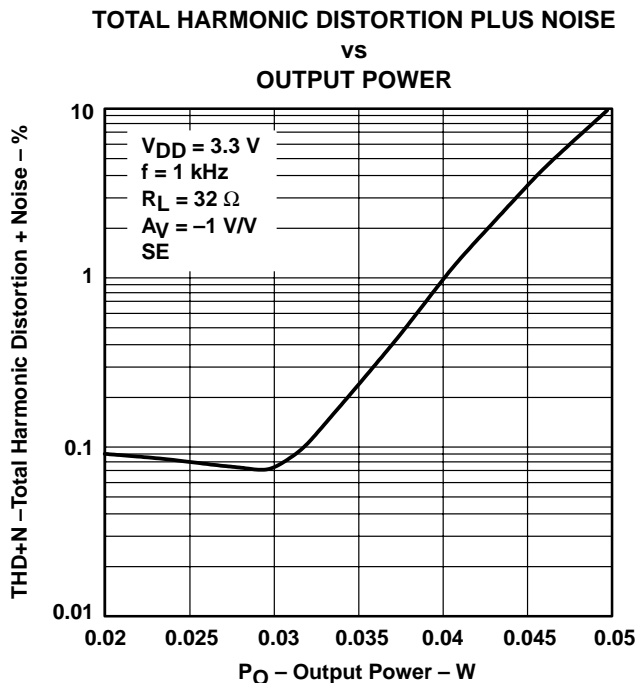

Figure 22

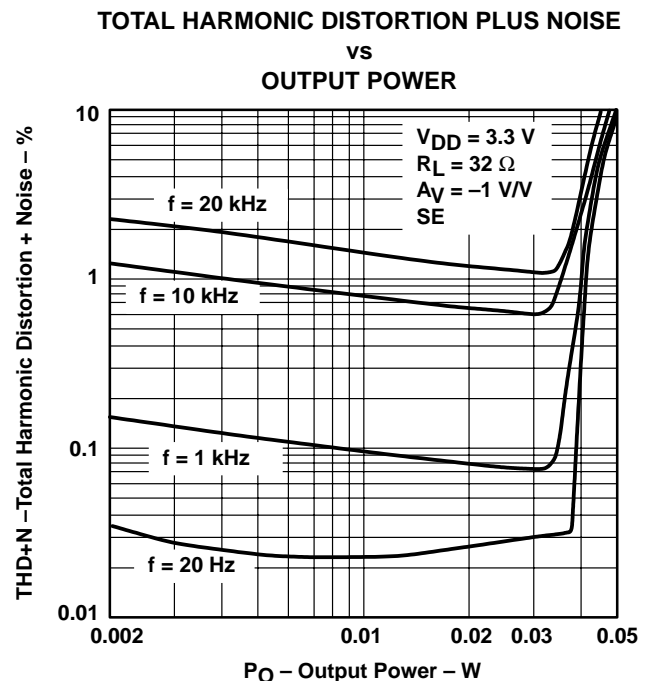

Figure 23

TPA311 350-mW MONO AUDIO POWER AMPLIFIER

SLOS207C – JANUARY 1998 – REVISED MAY 2003

TYPICAL CHARACTERISTICS

TOTAL HARMONIC DISTORTION PLUS NOISE
vs
FREQUENCY

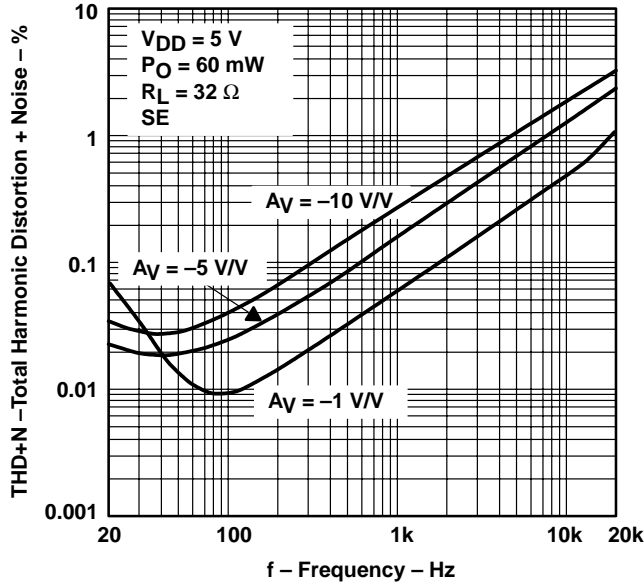

Figure 24

TOTAL HARMONIC DISTORTION PLUS NOISE
vs
FREQUENCY

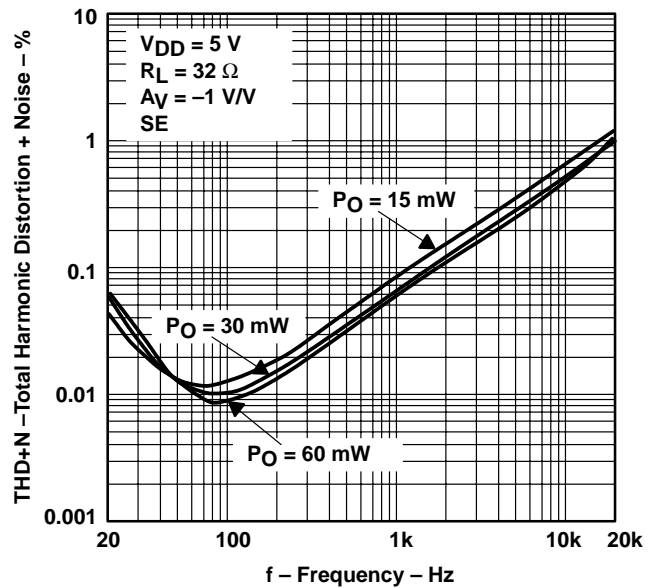

Figure 25

TOTAL HARMONIC DISTORTION PLUS NOISE
vs
OUTPUT POWER

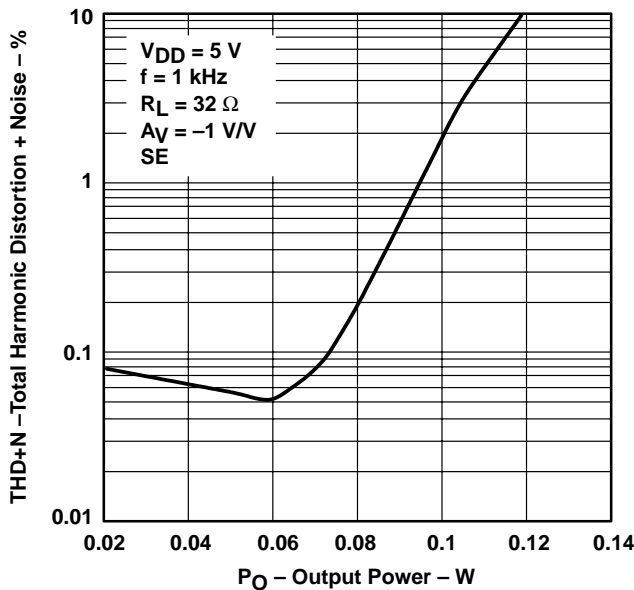

Figure 26

TOTAL HARMONIC DISTORTION PLUS NOISE
vs
OUTPUT POWER

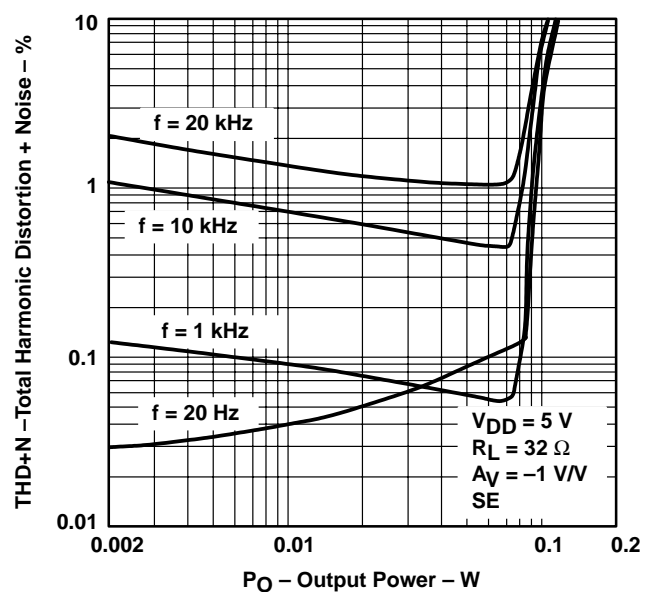

Figure 27



TYPICAL CHARACTERISTICS

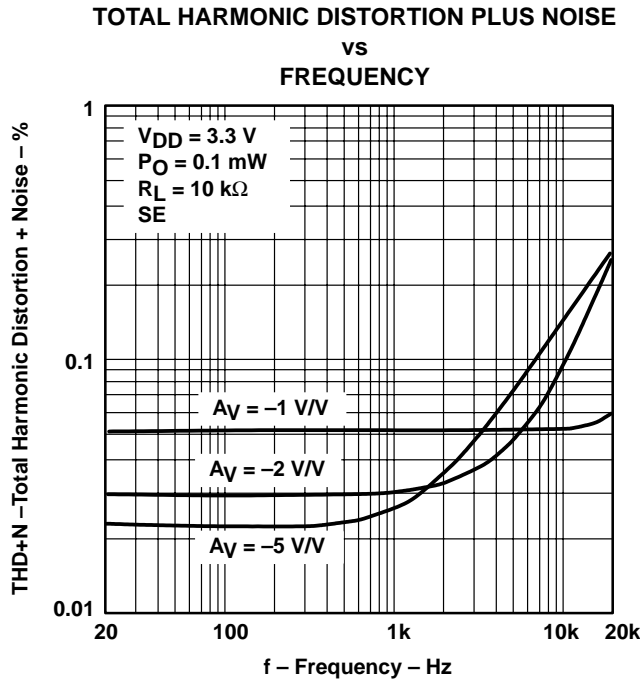

Figure 28

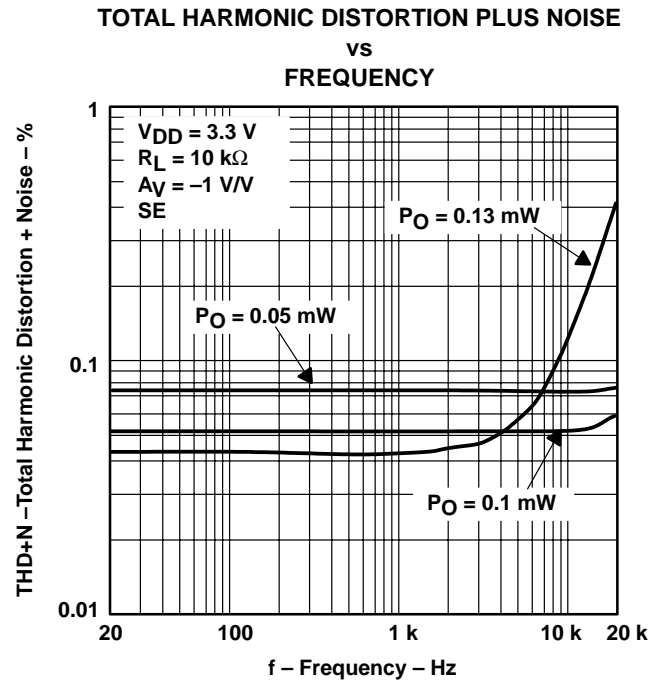

Figure 29

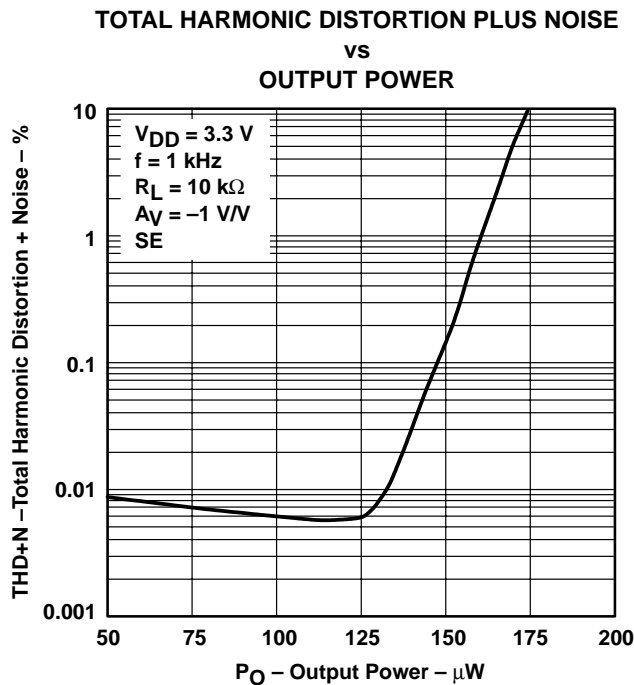

Figure 30

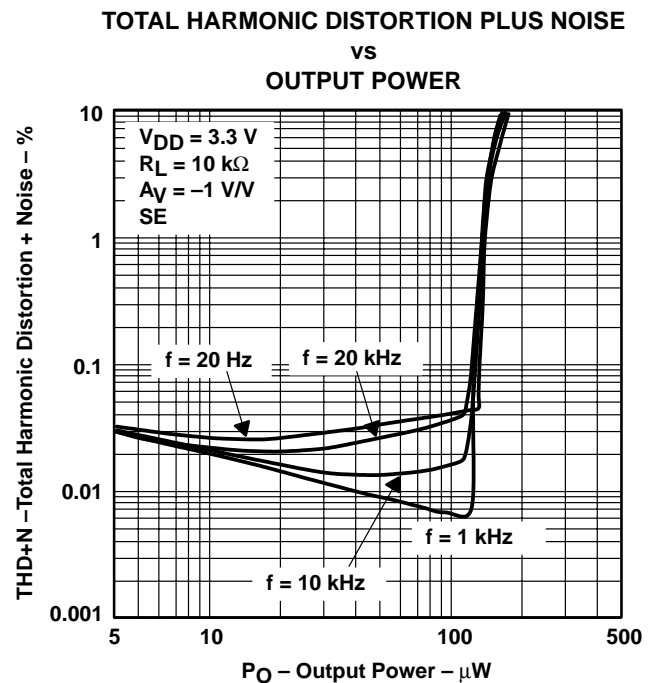

Figure 31

TPA311
350-mW MONO AUDIO POWER AMPLIFIER

SLOS207C – JANUARY 1998 – REVISED MAY 2003

TYPICAL CHARACTERISTICS

**TOTAL HARMONIC DISTORTION PLUS NOISE
 VS
 FREQUENCY**

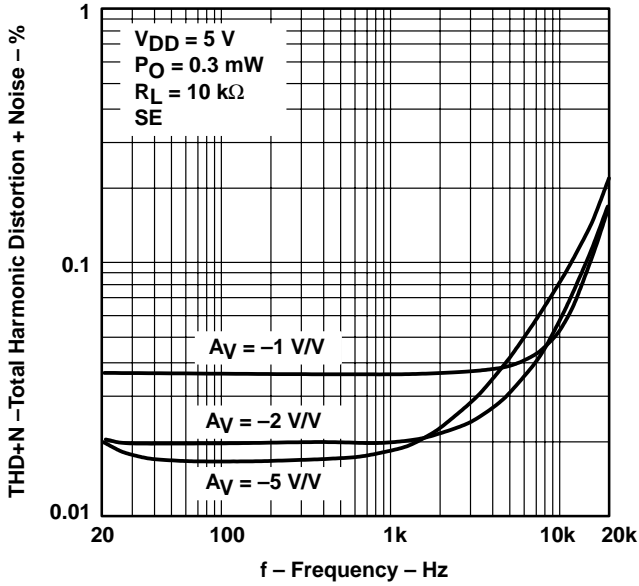

Figure 32

**TOTAL HARMONIC DISTORTION PLUS NOISE
 VS
 FREQUENCY**

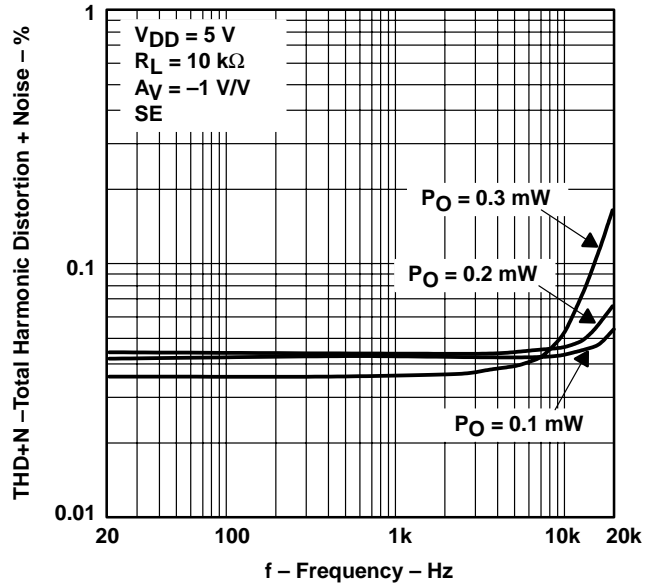

Figure 33

**TOTAL HARMONIC DISTORTION PLUS NOISE
 VS
 OUTPUT POWER**

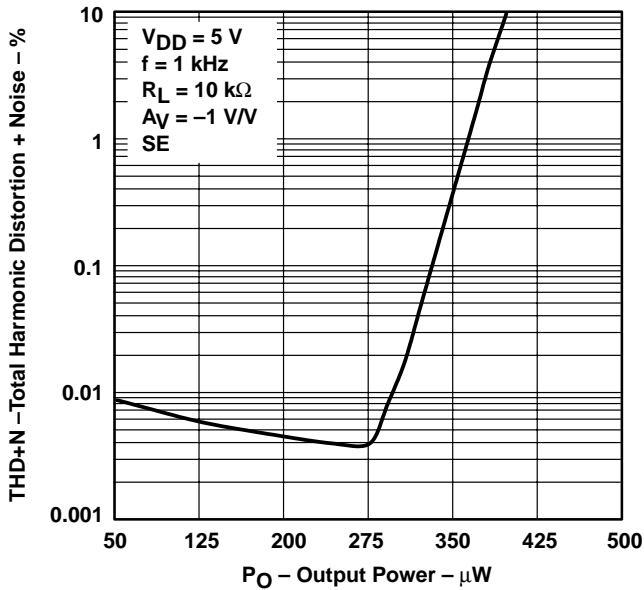

Figure 34

**TOTAL HARMONIC DISTORTION PLUS NOISE
 VS
 OUTPUT POWER**

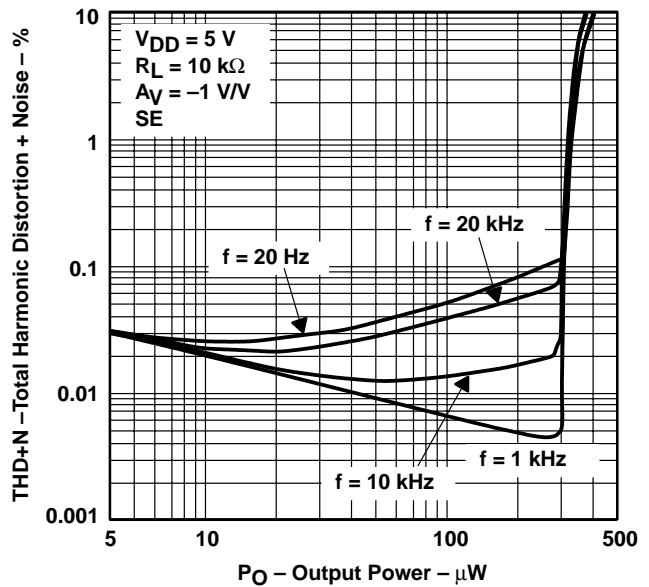

Figure 35



TYPICAL CHARACTERISTICS

OPEN-LOOP GAIN AND PHASE
 vs
 FREQUENCY

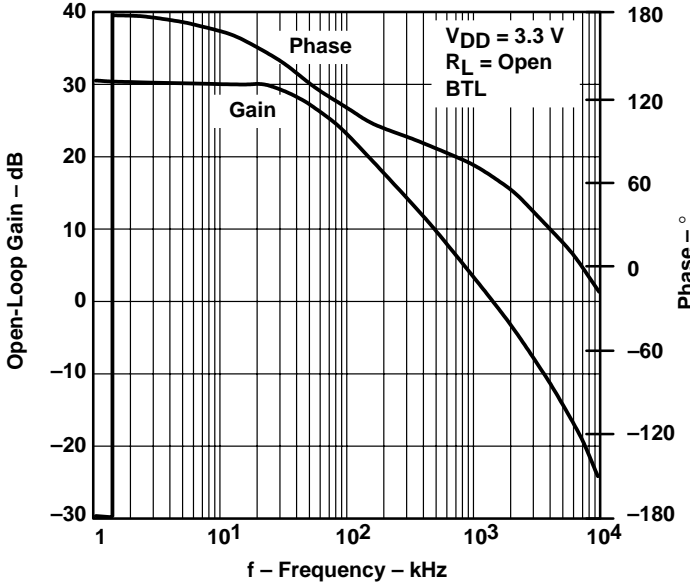

Figure 36

OPEN-LOOP GAIN AND PHASE
 vs
 FREQUENCY

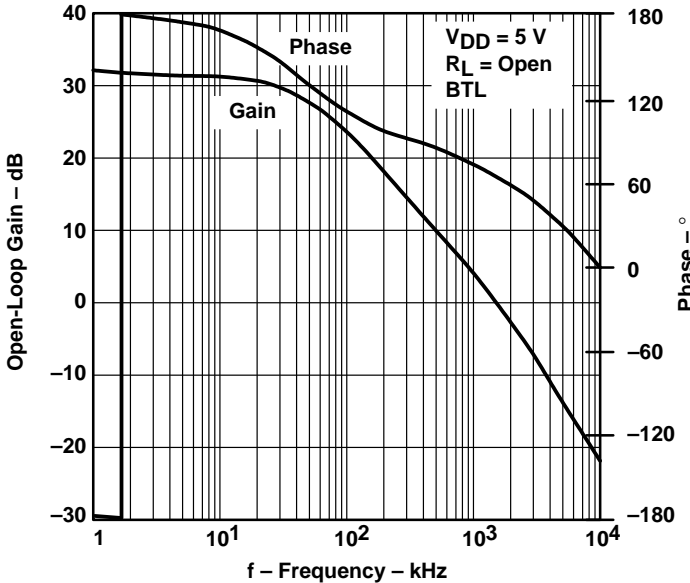

Figure 37

TPA311
350-mW MONO AUDIO POWER AMPLIFIER

SLOS207C – JANUARY 1998 – REVISED MAY 2003

TYPICAL CHARACTERISTICS

**CLOSED-LOOP GAIN AND PHASE
 vs
 FREQUENCY**

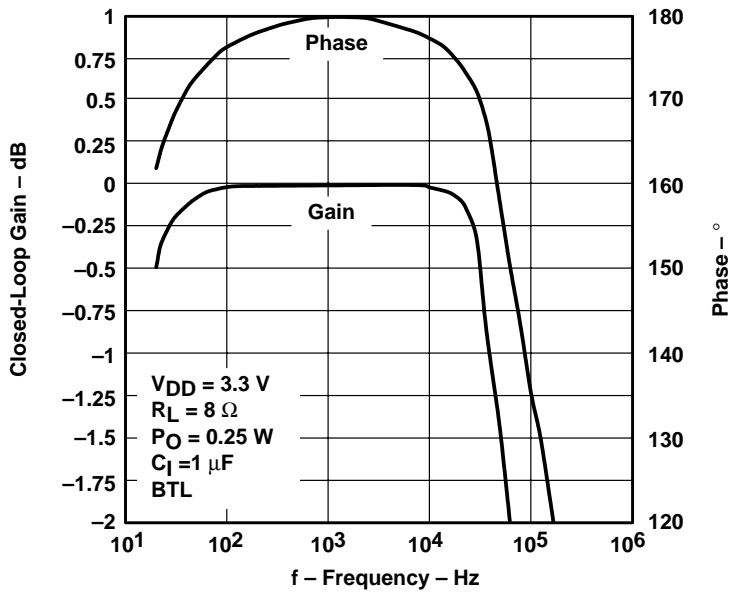

Figure 38

**CLOSED-LOOP GAIN AND PHASE
 vs
 FREQUENCY**

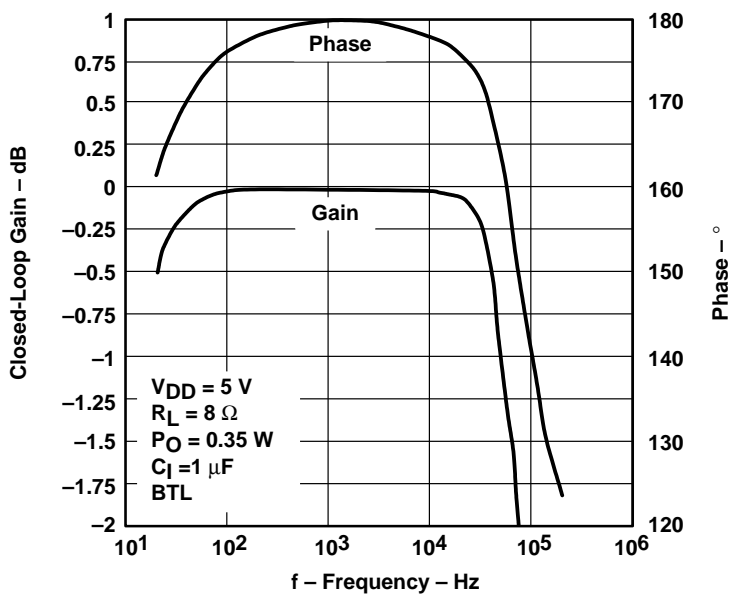

Figure 39



TYPICAL CHARACTERISTICS

CLOSED-LOOP GAIN AND PHASE
vs
FREQUENCY

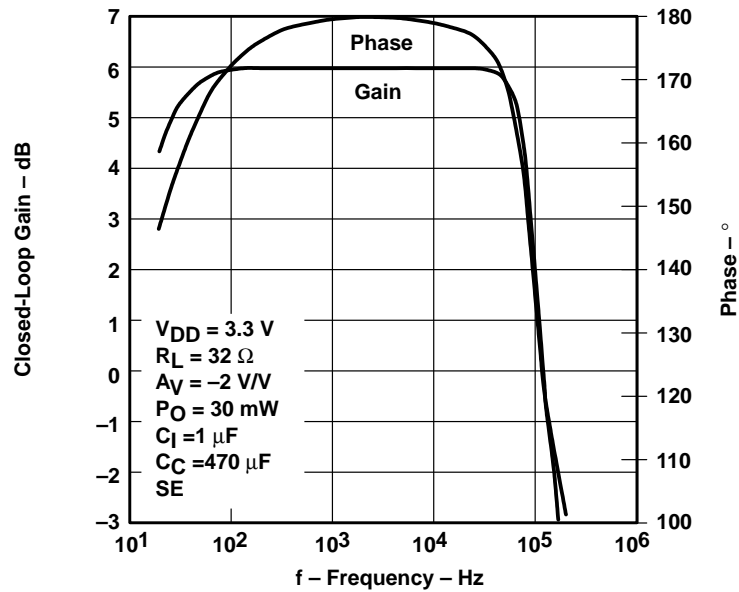

Figure 40

CLOSED-LOOP GAIN AND PHASE
vs
FREQUENCY

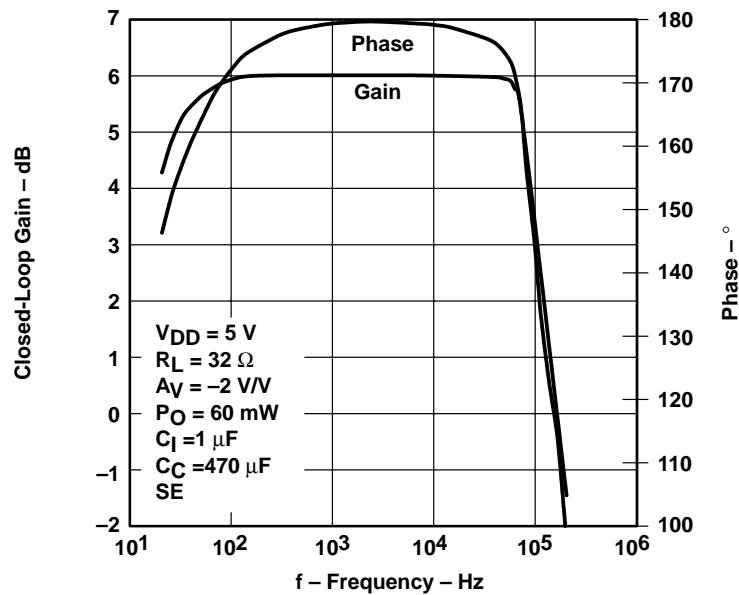

Figure 41

TPA311 350-mW MONO AUDIO POWER AMPLIFIER

SLOS207C – JANUARY 1998 – REVISED MAY 2003

TYPICAL CHARACTERISTICS

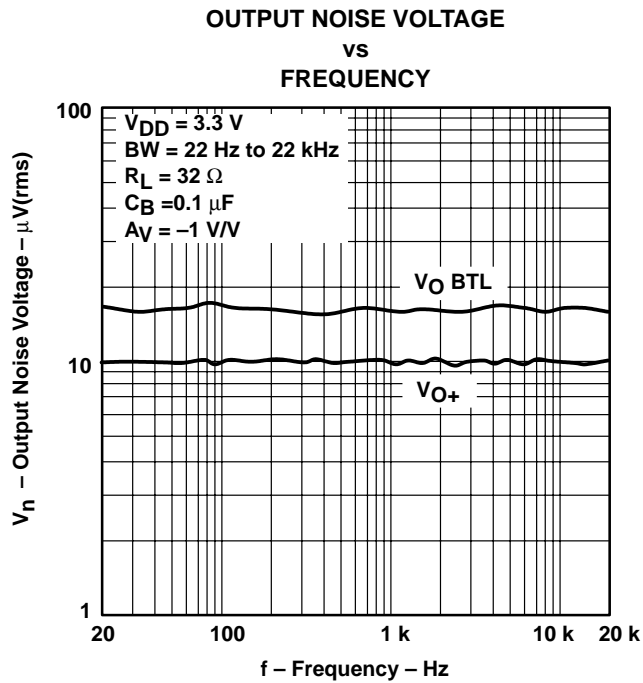

Figure 42

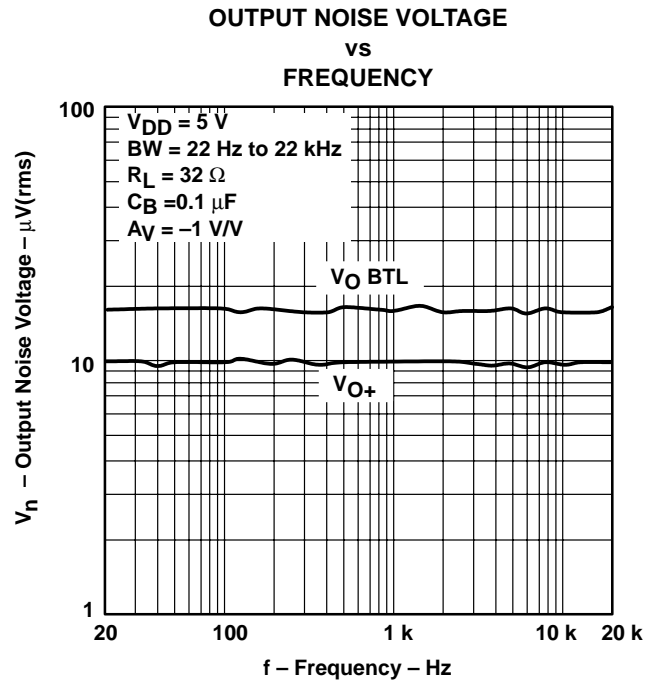

Figure 43

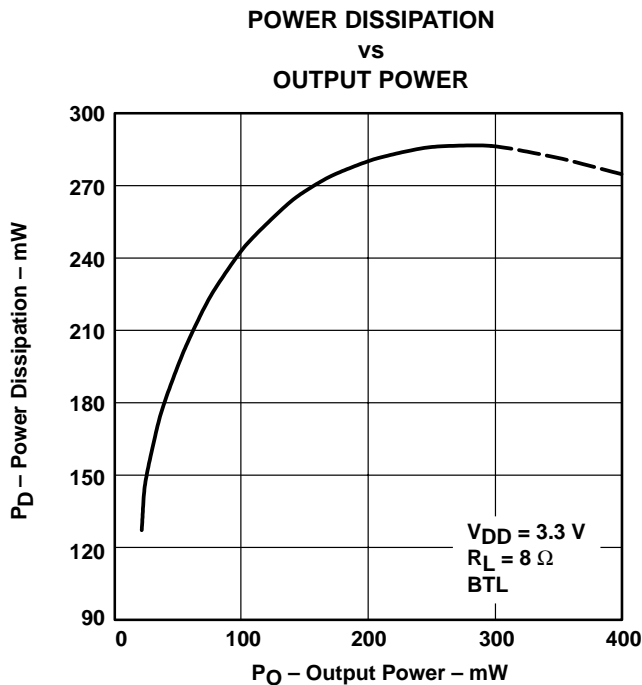

Figure 44

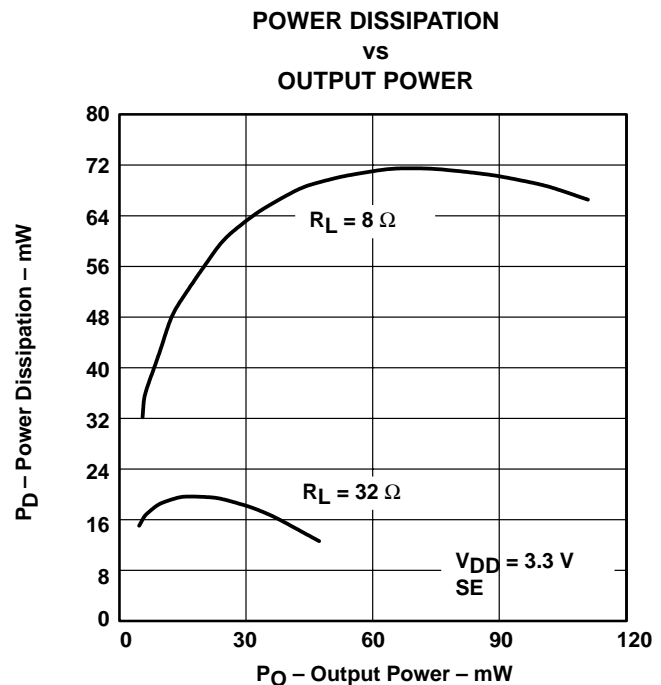

Figure 45



TYPICAL CHARACTERISTICS

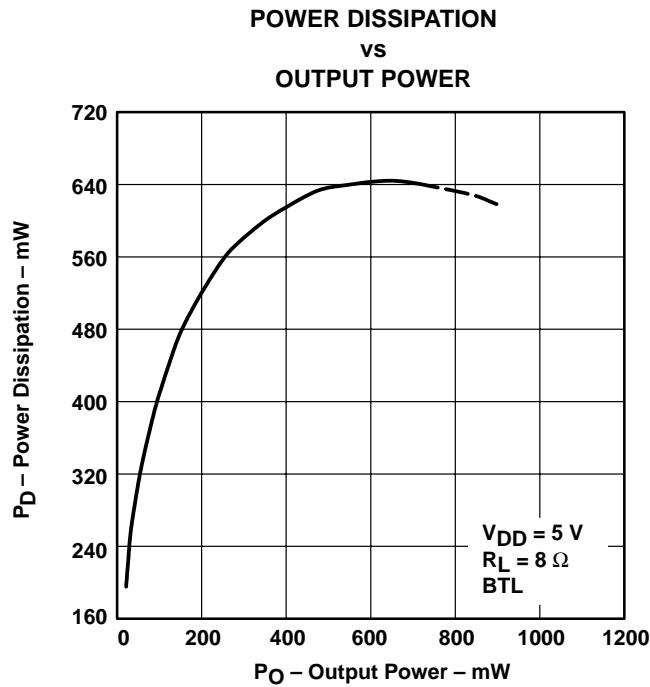

Figure 46

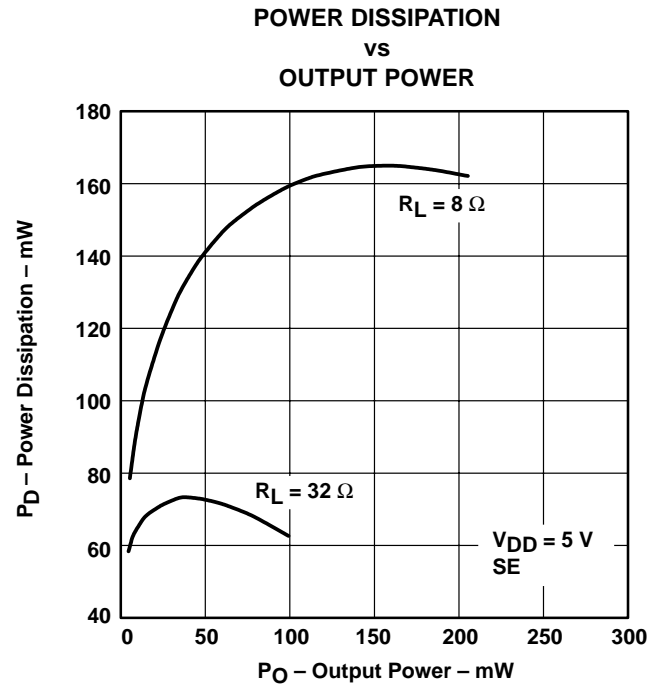

Figure 47

APPLICATION INFORMATION

bridge-tied load versus single-ended mode

Figure 48 shows a linear audio power amplifier (APA) in a BTL configuration. The TPA311 BTL amplifier consists of two linear amplifiers driving both ends of the load. There are several potential benefits to this differential drive configuration but initially consider power to the load. The differential drive to the speaker means that as one side is slewing up, the other side is slewing down, and vice versa. This in effect doubles the voltage swing on the load as compared to a ground referenced load. Plugging $2 \times V_{O(PP)}$ into the power equation, where voltage is squared, yields $4 \times$ the output power from the same supply rail and load impedance (see equation 1).

$$V_{(rms)} = \frac{V_{O(PP)}}{2\sqrt{2}}$$

$$Power = \frac{V_{(rms)}^2}{R_L} \tag{1}$$

APPLICATION INFORMATION

bridge-tied load versus single-ended mode (continued)

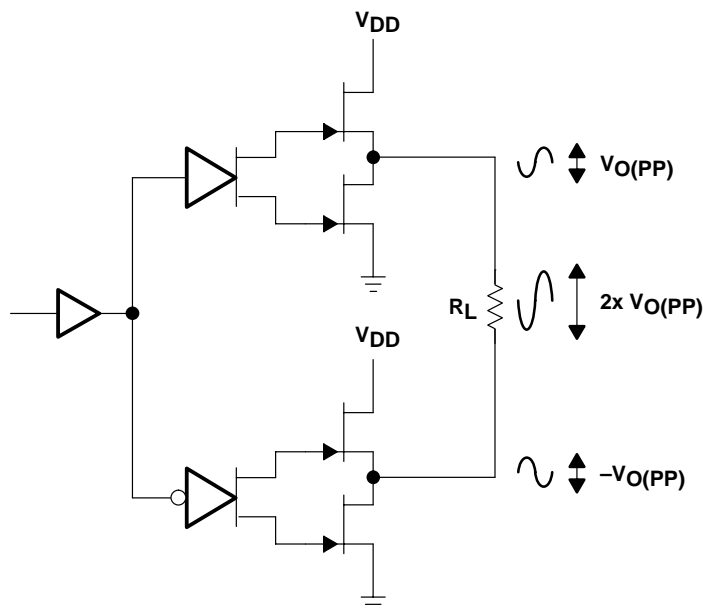

Figure 48. Bridge-Tied Load Configuration

In typical portable handheld equipment, a sound channel operating at 3.3 V and using bridging raises the power into an 8-Ω speaker from a single-ended (SE, ground reference) limit of 62.5 mW to 250 mW. In terms of sound power that is a 6-dB improvement, which is loudness that can be heard. In addition to increased power there are frequency response concerns. Consider the single-supply SE configuration shown in Figure 49. A coupling capacitor is required to block the dc offset voltage from reaching the load. These capacitors can be quite large (approximately 33 μF to 1000 μF), tend to be expensive, heavy, and occupy valuable PCB area. These capacitors also have the additional drawback of limiting low-frequency performance of the system. This frequency limiting effect is due to the high-pass filter network created with the speaker impedance and the coupling capacitance and is calculated with equation 2.

$$f_c = \frac{1}{2\pi R_L C_C} \tag{2}$$

For example, a 68-μF capacitor with an 8-Ω speaker would attenuate low frequencies below 293 Hz. The BTL configuration cancels the dc offsets, which eliminates the need for the blocking capacitors. Low-frequency performance is then limited only by the input network and speaker response. Cost and PCB space are also minimized by eliminating the bulky coupling capacitor.

APPLICATION INFORMATION

bridge-tied load versus single-ended mode (continued)

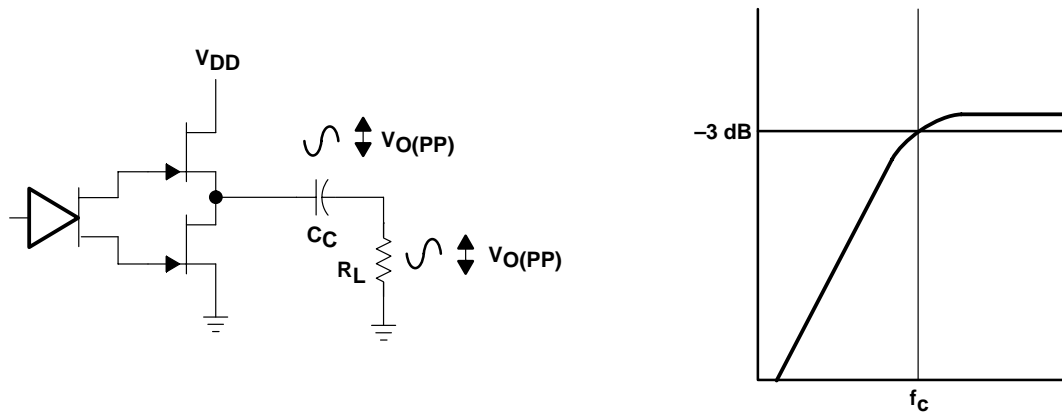

Figure 49. Single-Ended Configuration and Frequency Response

Increasing power to the load does carry a penalty of increased internal power dissipation. The increased dissipation is understandable, considering that the BTL configuration produces 4× the output power of the SE configuration. Internal dissipation versus output power is discussed further in the *thermal considerations* section.

BTL amplifier efficiency

Linear amplifiers are notoriously inefficient. The primary cause of these inefficiencies is voltage drop across the output stage transistors. There are two components of the internal voltage drop. One is the headroom or dc voltage drop that varies inversely to output power. The second component is due to the sinewave nature of the output. The total voltage drop can be calculated by subtracting the RMS value of the output voltage from V_{DD} . The internal voltage drop multiplied by the RMS value of the supply current, $I_{DD\text{rms}}$, determines the internal power dissipation of the amplifier.

An easy-to-use equation to calculate efficiency starts out as being equal to the ratio of power from the power supply to the power delivered to the load. To accurately calculate the RMS values of power in the load and in the amplifier, the current and voltage waveform shapes must first be understood (see Figure 50).

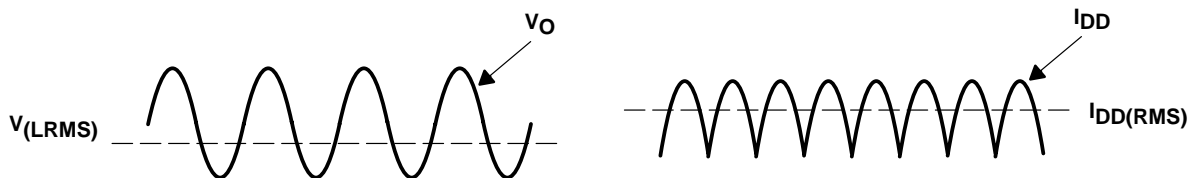

Figure 50. Voltage and Current Waveforms for BTL Amplifiers

TPA311

350-mW MONO AUDIO POWER AMPLIFIER

SLOS207C – JANUARY 1998 – REVISED MAY 2003

APPLICATION INFORMATION

BTL amplifier efficiency (continued)

Although the voltages and currents for SE and BTL are sinusoidal in the load, currents from the supply are very different between SE and BTL configurations. In an SE application the current waveform is a half-wave rectified shape whereas, in BTL it is a full-wave rectified waveform. This means RMS conversion factors are different. Keep in mind that for most of the waveform, both the push and pull transistors are not on at the same time, which supports the fact that each amplifier in the BTL device only draws current from the supply for half the waveform. The following equations are the basis for calculating amplifier efficiency.

$$\text{Efficiency} = \frac{P_L}{P_{\text{SUP}}} \quad (3)$$

where

$$P_L = \frac{V_{L\text{rms}}^2}{R_L} = \frac{V_P^2}{2R_L}$$

$$V_{L\text{rms}} = \frac{V_P}{\sqrt{2}}$$

$$P_{\text{SUP}} = V_{DD} I_{DD\text{rms}} = \frac{V_{DD} 2V_P}{\pi R_L}$$

$$I_{DD\text{rms}} = \frac{2V_P}{\pi R_L}$$

$$\text{Efficiency of a BTL Configuration} = \frac{\pi V_P}{2V_{DD}} = \frac{\pi \left(\frac{P_L R_L}{2} \right)^{1/2}}{2V_{DD}} \quad (4)$$

Table 1 employs equation 4 to calculate efficiencies for three different output power levels. The efficiency of the amplifier is quite low for lower power levels and rises sharply as power to the load is increased resulting in a nearly flat internal power dissipation over the normal operating range. The internal dissipation at full output power is less than in the half power range. Calculating the efficiency for a specific system is the key to proper power supply design.

Table 1. Efficiency Vs Output Power in 3.3-V 8-Ω BTL Systems

OUTPUT POWER (W)	EFFICIENCY (%)	PEAK-TO-PEAK VOLTAGE (V)	INTERNAL DISSIPATION (W)
0.125	33.6	1.41	0.26
0.25	47.6	2.00	0.29
0.375	58.3	2.45†	0.28

† High-peak voltage values cause the THD to increase.

A final point to remember about linear amplifiers (either SE or BTL) is how to manipulate the terms in the efficiency equation to utmost advantage when possible. In equation 4, V_{DD} is in the denominator. This indicates that as V_{DD} goes down, efficiency goes up.

APPLICATION INFORMATION

application schematic

Figure 51 is a schematic diagram of a typical handheld audio application circuit, configured for a gain of -10 V/V.

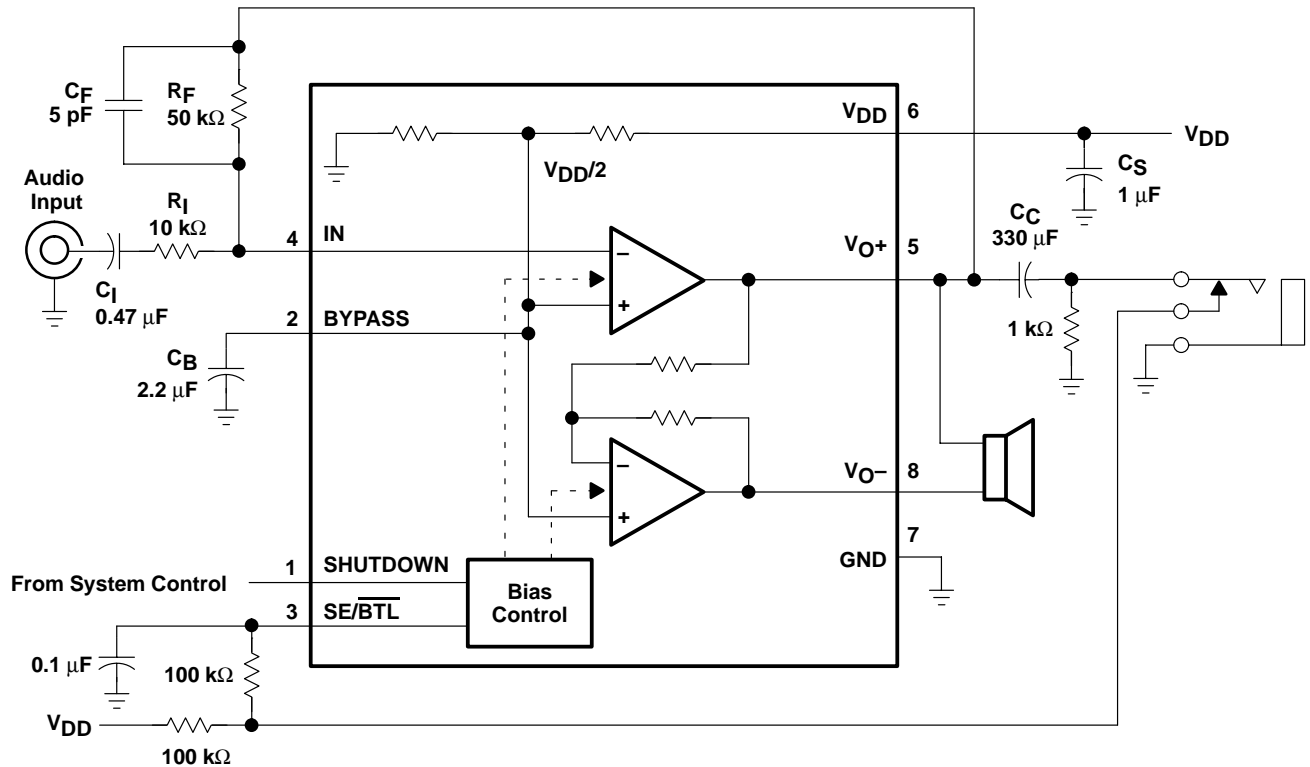

Figure 51. TPA311 Application Circuit

The following sections discuss the selection of the components used in Figure 51.

component selection

gain setting resistors, R_F and R_I

The gain for each audio input of the TPA311 is set by resistors R_F and R_I according to equation 5 for BTL mode.

$$\text{BTL Gain} = A_V = -2 \left(\frac{R_F}{R_I} \right) \quad (5)$$

BTL mode operation brings about the factor 2 in the gain equation due to the inverting amplifier mirroring the voltage swing across the load. Given that the TPA311 is a MOS amplifier, the input impedance is very high, consequently input leakage currents are not generally a concern, although noise in the circuit increases as the value of R_F increases. In addition, a certain range of R_F values is required for proper start-up operation of the amplifier. Taken together it is recommended that the effective impedance seen by the inverting node of the amplifier be set between 5 kΩ and 20 kΩ. The effective impedance is calculated in equation 6.

$$\text{Effective Impedance} = \frac{R_F R_I}{R_F + R_I} \quad (6)$$

TPA311

350-mW MONO AUDIO POWER AMPLIFIER

SLOS207C – JANUARY 1998 – REVISED MAY 2003

APPLICATION INFORMATION

component selection (continued)

As an example consider an input resistance of 10 kΩ and a feedback resistor of 50 kΩ. The BTL gain of the amplifier would be –10 V/V and the effective impedance at the inverting terminal would be 8.3 kΩ, which is well within the recommended range.

For high performance applications, metal film resistors are recommended because they tend to have lower noise levels than carbon resistors. For values of R_F above 50 kΩ the amplifier tends to become unstable due to a pole formed from R_F and the inherent input capacitance of the MOS input structure. For this reason, a small compensation capacitor, C_F, of approximately 5 pF should be placed in parallel with R_F when R_F is greater than 50 kΩ. This, in effect, creates a low pass filter network with the cutoff frequency defined in equation 7.

$$f_{c(\text{lowpass})} = \frac{1}{2\pi R_F C_F} \quad (7)$$

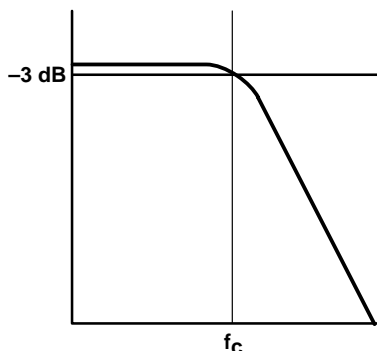

For example, if R_F is 100 kΩ and C_F is 5 pF then f_c is 318 kHz, which is well outside the audio range.

input capacitor, C_I

In the typical application an input capacitor, C_I, is required to allow the amplifier to bias the input signal to the proper dc level for optimum operation. In this case, C_I and R_I form a high-pass filter with the corner frequency determined in equation 8.

$$f_{c(\text{highpass})} = \frac{1}{2\pi R_I C_I} \quad (8)$$

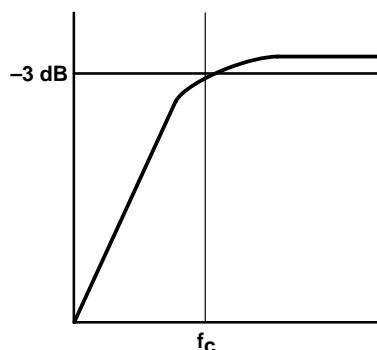

The value of C_I is important to consider as it directly affects the bass (low frequency) performance of the circuit. Consider the example where R_I is 10 kΩ and the specification calls for a flat bass response down to 40 Hz. Equation 8 is reconfigured as equation 9.

$$C_I = \frac{1}{2\pi R_I f_c} \quad (9)$$

APPLICATION INFORMATION

component selection (continued)

In this example, C_I is $0.40 \mu\text{F}$, so one would likely choose a value in the range of $0.47 \mu\text{F}$ to $1 \mu\text{F}$. A further consideration for this capacitor is the leakage path from the input source through the input network (R_I , C_I) and the feedback resistor (R_F) to the load. This leakage current creates a dc offset voltage at the input to the amplifier that reduces useful headroom, especially in high gain applications. For this reason a low-leakage tantalum or ceramic capacitor is the best choice. When polarized capacitors are used, the positive side of the capacitor should face the amplifier input in most applications as the dc level there is held at $V_{DD}/2$, which is likely higher than the source dc level. It is important to confirm the capacitor polarity in the application.

power supply decoupling, C_S

The TPA311 is a high-performance CMOS audio amplifier that requires adequate power supply decoupling to ensure the output total harmonic distortion (THD) is as low as possible. Power supply decoupling also prevents oscillations for long lead lengths between the amplifier and the speaker. The optimum decoupling is achieved by using two capacitors of different types that target different types of noise on the power supply leads. For higher frequency transients, spikes, or digital hash on the line, a good low equivalent-series-resistance (ESR) ceramic capacitor, typically $0.1 \mu\text{F}$ placed as close as possible to the device V_{DD} lead, works best. For filtering lower-frequency noise signals, a larger aluminum electrolytic capacitor of $10 \mu\text{F}$ or greater placed near the audio power amplifier is recommended.

midrail bypass capacitor, C_B

The midrail bypass capacitor, C_B , is the most critical capacitor and serves several important functions. During start-up or recovery from shutdown mode, C_B determines the rate at which the amplifier starts up. The second function is to reduce noise produced by the power supply caused by coupling into the output drive signal. This noise is from the midrail generation circuit internal to the amplifier, which appears as degraded PSRR and THD + N. The capacitor is fed from a $250\text{-k}\Omega$ source inside the amplifier. To keep the start-up pop as low as possible, the relationship shown in equation 10 should be maintained, which insures the input capacitor is fully charged before the bypass capacitor is fully charged and the amplifier starts up.

$$\frac{10}{(C_B \times 250 \text{ k}\Omega)} \leq \frac{1}{(R_F + R_I) C_I} \quad (10)$$

As an example, consider a circuit where C_B is $2.2 \mu\text{F}$, C_I is $0.47 \mu\text{F}$, R_F is $50 \text{ k}\Omega$ and R_I is $10 \text{ k}\Omega$. Inserting these values into the equation 10 we get: $18.2 \leq 35.5$ which satisfies the rule. Bypass capacitor, C_B , values of $0.1 \mu\text{F}$ to $2.2 \mu\text{F}$ ceramic or tantalum low-ESR capacitors are recommended for the best THD and noise performance.

single-ended operation

In SE mode (see Figure 51), the load is driven from the primary amplifier output (V_{O+} , terminal 5).

In SE mode the gain is set by the R_F and R_I resistors and is shown in equation 11. Since the inverting amplifier is not used to mirror the voltage swing on the load, the factor of 2, from equation 5, is not included.

$$\text{SE Gain} = A_V = - \left(\frac{R_F}{R_I} \right) \quad (11)$$

TPA311

350-mW MONO AUDIO POWER AMPLIFIER

SLOS207C – JANUARY 1998 – REVISED MAY 2003

APPLICATION INFORMATION

single-ended operation (continued)

The output coupling capacitor required in single-supply SE mode also places additional constraints on the selection of other components in the amplifier circuit. The rules described earlier still hold with the addition of the following relationship:

$$\frac{10}{(C_B \times 250 \text{ k}\Omega)} \leq \frac{1}{(R_F + R_I) C_I} \ll \frac{1}{R_L C_C} \quad (12)$$

As an example, consider a circuit where C_B is 0.2.2 μF , C_I is 0.47 μF , C_C is 330 μF , R_F is 50 k Ω , R_L is 32 Ω , and R_I is 10 k Ω . Inserting these values into the equation 12 we get:

$$18.2 < 35.5 \ll 94.7 \text{ which satisfies the rule.}$$

output coupling capacitor, C_C

In the typical single-supply SE configuration, an output coupling capacitor (C_C) is required to block the dc bias at the output of the amplifier, thus preventing dc currents in the load. As with the input coupling capacitor, the output coupling capacitor and impedance of the load form a high-pass filter governed by equation 13.

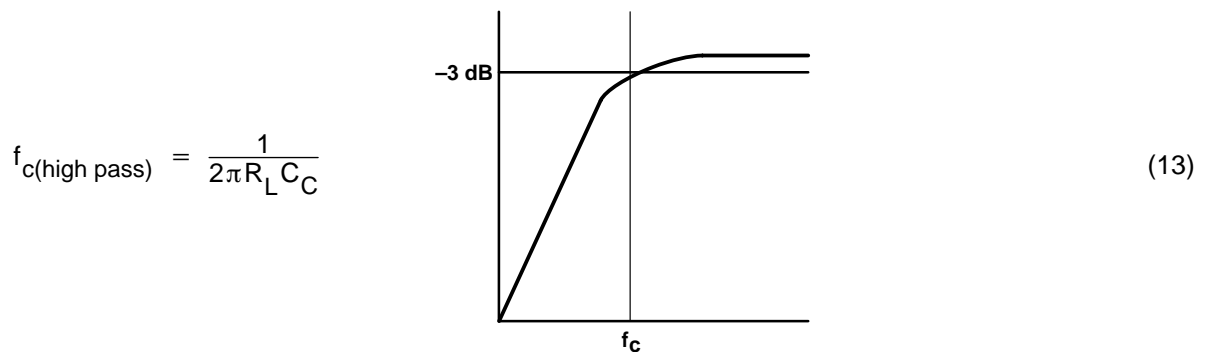

The main disadvantage, from a performance standpoint, is that the typically small load impedances drive the low-frequency corner higher degrading the bass response. Large values of C_C are required to pass low frequencies into the load. Consider the example where a C_C of 330 μF is chosen and loads vary from 8 Ω , 32 Ω , to 47 k Ω . Table 2 summarizes the frequency response characteristics of each configuration.

Table 2. Common Load Impedances vs Low Frequency Output Characteristics in SE Mode

R_L	C_C	LOWEST FREQUENCY
8 Ω	330 μF	60 Hz
32 Ω	330 μF	15 Hz
47,000 Ω	330 μF	0.01 Hz

As Table 2 indicates an 8- Ω load is adequate, earphone response is good, and drive into line level inputs (a home stereo for example) is exceptional.

APPLICATION INFORMATION

SE/BTL operation

The ability of the TPA311 to easily switch between BTL and SE modes is one of its most important cost saving features. This feature eliminates the requirement for an additional earphone amplifier in applications where internal speakers are driven in BTL mode but external earphone or speaker must be accommodated. Internal to the TPA311, two separate amplifiers drive V_{O+} and V_{O-} . The SE/BTL input (terminal 3) controls the operation of the follower amplifier that drives V_{O-} (terminal 8). When SE/BTL is held low, the amplifier is on and the TPA311 is in the BTL mode. When SE/BTL is held high, the V_{O-} amplifier is in a high output impedance state, which configures the TPA311 as an SE driver from V_{O+} (terminal 5). I_{DD} is reduced by approximately one-half in SE mode. Control of the SE/BTL input can be from a logic-level TTL source or, more typically, from a resistor divider network as shown in Figure 52.

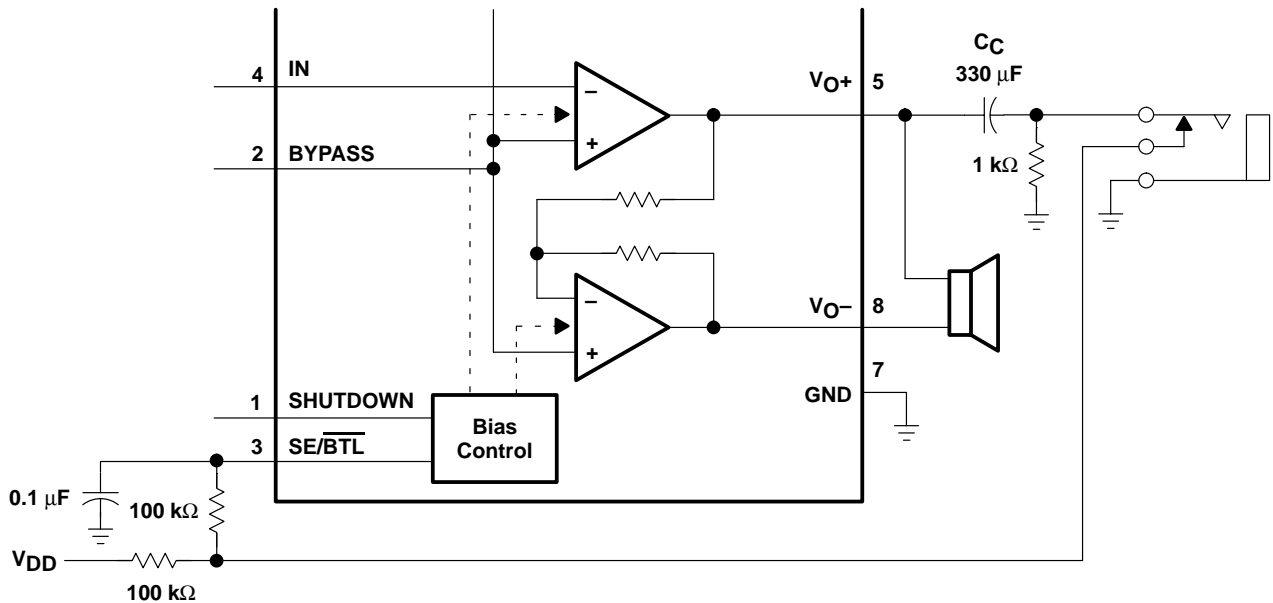

Figure 52. TPA311 Resistor Divider Network Circuit

Using a readily available 1/8-in. (3,5 mm) mono earphone jack, the control switch is closed when no plug is inserted. When closed the 100-kΩ/1-kΩ divider pulls the SE/BTL input low. When a plug is inserted, the 1-kΩ resistor is disconnected and the SE/BTL input is pulled high. When the input goes high, the V_{O-} amplifier is shutdown causing the BTL speaker to mute (virtually open-circuits the speaker). The V_{O+} amplifier then drives through the output capacitor (C_C) into the earphone jack.

using low-ESR capacitors

Low-ESR capacitors are recommended throughout this application. A real (as opposed to ideal) capacitor can be modeled simply as a resistor in series with an ideal capacitor. The voltage drop across this resistor minimizes the beneficial effects of the capacitor in the circuit. The lower the equivalent value of this resistance the more the real capacitor behaves like an ideal capacitor.

TPA311

350-mW MONO AUDIO POWER AMPLIFIER

SLOS207C – JANUARY 1998 – REVISED MAY 2003

APPLICATION INFORMATION

5-V versus 3.3-V operation

The TPA311 operates over a supply range of 2.5 V to 5.5 V. This data sheet provides full specifications for 5-V and 3.3-V operation, as these are considered to be the two most common standard voltages. There are no special considerations for 3.3-V versus 5-V operation with respect to supply bypassing, gain setting, or stability. The most important consideration is that of output power. Each amplifier in TPA311 can produce a maximum voltage swing of $V_{DD} - 1$ V. This means, for 3.3-V operation, clipping starts to occur when $V_{O(PP)} = 2.3$ V as opposed to $V_{O(PP)} = 4$ V at 5 V. The reduced voltage swing subsequently reduces maximum output power into an 8- Ω load before distortion becomes significant.

Operation from 3.3-V supplies, as can be shown from the efficiency formula in equation 4, consumes approximately two-thirds the supply power for a given output-power level of operation from 5-V supplies.

headroom and thermal considerations

Linear power amplifiers dissipate a significant amount of heat in the package under normal operating conditions. A typical music CD requires 12 dB to 15 dB of dynamic headroom to pass the loudest portions without distortion as compared with the average power output. From the TPA311 data sheet, one can see that when the TPA311 is operating from a 5-V supply into a 8- Ω speaker that 350 mW peaks are available. Converting watts to dB:

$$\begin{aligned} P_{dB} &= 10 \text{Log} \left(\frac{P_W}{P_{ref}} \right) \\ &= 10 \text{Log} \left(\frac{350 \text{ mW}}{1 \text{ W}} \right) \\ &= -4.6 \text{ dB} \end{aligned}$$

Subtracting the headroom restriction to obtain the average listening level without distortion yields:

$$\begin{aligned} -4.6 \text{ dB} - 15 \text{ dB} &= -19.6 \text{ dB (15 dB headroom)} \\ -4.6 \text{ dB} - 12 \text{ dB} &= -16.6 \text{ dB (12 dB headroom)} \\ -4.6 \text{ dB} - 9 \text{ dB} &= -13.6 \text{ dB (9 dB headroom)} \\ -4.6 \text{ dB} - 6 \text{ dB} &= -10.6 \text{ dB (6 dB headroom)} \\ -4.6 \text{ dB} - 3 \text{ dB} &= -7.6 \text{ dB (3 dB headroom)} \end{aligned}$$

Converting dB back into watts:

$$\begin{aligned} P_W &= 10^{P_{dB}/10} \times P_{ref} \\ &= 11 \text{ mW (15 dB headroom)} \\ &= 22 \text{ mW (12 dB headroom)} \\ &= 44 \text{ mW (9 dB headroom)} \\ &= 88 \text{ mW (6 dB headroom)} \\ &= 175 \text{ mW (3 dB headroom)} \end{aligned}$$

APPLICATION INFORMATION

headroom and thermal considerations (continued)

This is valuable information to consider when attempting to estimate the heat dissipation requirements for the amplifier system. Comparing the absolute worst case, which is 350 mW of continuous power output with 0 dB of headroom, against 12 dB and 15 dB applications drastically affects maximum ambient temperature ratings for the system. Using the power dissipation curves for a 5-V, 8-Ω system, the internal dissipation in the TPA311 and maximum ambient temperatures is shown in Table 3.

Table 3. TPA311 Power Rating, 5-V, 8-Ω, BTL

PEAK OUTPUT POWER (mW)	AVERAGE OUTPUT POWER	POWER DISSIPATION (mW)	MAXIMUM AMBIENT TEMPERATURE	
			0 CFM SOIC	0 CFM DGN
350	350 mW	600	46°C	114°C
350	175 mW (3 dB)	500	64°C	120°C
350	88 mW (6 dB)	380	85°C	125°C
350	44 mW (9 dB)	300	98°C	125°C
350	22 mW (12 dB)	200	115°C	125°C
350	11 mW (15 dB)	180	119°C	125°C

Table 3 shows that the TPA311 can be used to its full 350-mW rating without any heat sinking in still air up to 46°C.

PACKAGING INFORMATION

Orderable Device	Status ⁽¹⁾	Package Type	Package Drawing	Pins	Package Qty	Eco Plan ⁽²⁾	Lead/ Ball Finish	MSL Peak Temp ⁽³⁾	Samples (Requires Login)
TPA311D	ACTIVE	SOIC	D	8	75	Green (RoHS & no Sb/Br)	CU NIPDAU	Level-1-260C-UNLIM	Add to cart
TPA311DG4	ACTIVE	SOIC	D	8	75	Green (RoHS & no Sb/Br)	CU NIPDAU	Level-1-260C-UNLIM	Add to cart
TPA311DGN	ACTIVE	MSOP- PowerPAD	DGN	8	80	Green (RoHS & no Sb/Br)	CU NIPDAU	Level-1-260C-UNLIM	Add to cart
TPA311DGNG4	ACTIVE	MSOP- PowerPAD	DGN	8	80	Green (RoHS & no Sb/Br)	CU NIPDAU	Level-1-260C-UNLIM	Add to cart
TPA311DGNR	ACTIVE	MSOP- PowerPAD	DGN	8	2500	Green (RoHS & no Sb/Br)	CU NIPDAU	Level-1-260C-UNLIM	Add to cart
TPA311DGNRG4	ACTIVE	MSOP- PowerPAD	DGN	8	2500	Green (RoHS & no Sb/Br)	CU NIPDAU	Level-1-260C-UNLIM	Add to cart
TPA311DR	ACTIVE	SOIC	D	8	2500	Green (RoHS & no Sb/Br)	CU NIPDAU	Level-1-260C-UNLIM	Add to cart
TPA311DRG4	ACTIVE	SOIC	D	8	2500	Green (RoHS & no Sb/Br)	CU NIPDAU	Level-1-260C-UNLIM	Add to cart

⁽¹⁾ The marketing status values are defined as follows:

ACTIVE: Product device recommended for new designs.

LIFEBUY: TI has announced that the device will be discontinued, and a lifetime-buy period is in effect.

NRND: Not recommended for new designs. Device is in production to support existing customers, but TI does not recommend using this part in a new design.

PREVIEW: Device has been announced but is not in production. Samples may or may not be available.

OBSOLETE: TI has discontinued the production of the device.

⁽²⁾ Eco Plan - The planned eco-friendly classification: Pb-Free (RoHS), Pb-Free (RoHS Exempt), or Green (RoHS & no Sb/Br) - please check <http://www.ti.com/productcontent> for the latest availability information and additional product content details.

TBD: The Pb-Free/Green conversion plan has not been defined.

Pb-Free (RoHS): TI's terms "Lead-Free" or "Pb-Free" mean semiconductor products that are compatible with the current RoHS requirements for all 6 substances, including the requirement that lead not exceed 0.1% by weight in homogeneous materials. Where designed to be soldered at high temperatures, TI Pb-Free products are suitable for use in specified lead-free processes.

Pb-Free (RoHS Exempt): This component has a RoHS exemption for either 1) lead-based flip-chip solder bumps used between the die and package, or 2) lead-based die adhesive used between the die and leadframe. The component is otherwise considered Pb-Free (RoHS compatible) as defined above.

Green (RoHS & no Sb/Br): TI defines "Green" to mean Pb-Free (RoHS compatible), and free of Bromine (Br) and Antimony (Sb) based flame retardants (Br or Sb do not exceed 0.1% by weight in homogeneous material)

⁽³⁾ MSL, Peak Temp. -- The Moisture Sensitivity Level rating according to the JEDEC industry standard classifications, and peak solder temperature.

Important Information and Disclaimer: The information provided on this page represents TI's knowledge and belief as of the date that it is provided. TI bases its knowledge and belief on information provided by third parties, and makes no representation or warranty as to the accuracy of such information. Efforts are underway to better integrate information from third parties. TI has taken and continues to take reasonable steps to provide representative and accurate information but may not have conducted destructive testing or chemical analysis on incoming materials and chemicals. TI and TI suppliers consider certain information to be proprietary, and thus CAS numbers and other limited information may not be available for release.

In no event shall TI's liability arising out of such information exceed the total purchase price of the TI part(s) at issue in this document sold by TI to Customer on an annual basis.

TAPE AND REEL INFORMATION

REEL DIMENSIONS



TAPE DIMENSIONS



A0	Dimension designed to accommodate the component width
B0	Dimension designed to accommodate the component length
K0	Dimension designed to accommodate the component thickness
W	Overall width of the carrier tape
P1	Pitch between successive cavity centers

TAPE AND REEL INFORMATION

*All dimensions are nominal

Device	Package Type	Package Drawing	Pins	SPQ	Reel Diameter (mm)	Reel Width W1 (mm)	A0 (mm)	B0 (mm)	K0 (mm)	P1 (mm)	W (mm)	Pin1 Quadrant
TPA311DR	SOIC	D	8	2500	330.0	12.4	6.4	5.2	2.1	8.0	12.0	Q1

TAPE AND REEL BOX DIMENSIONS



*All dimensions are nominal

Device	Package Type	Package Drawing	Pins	SPQ	Length (mm)	Width (mm)	Height (mm)
TPA311DR	SOIC	D	8	2500	346.0	346.0	29.0

DGN (S-PDSO-G8)

PowerPAD™ PLASTIC SMALL OUTLINE

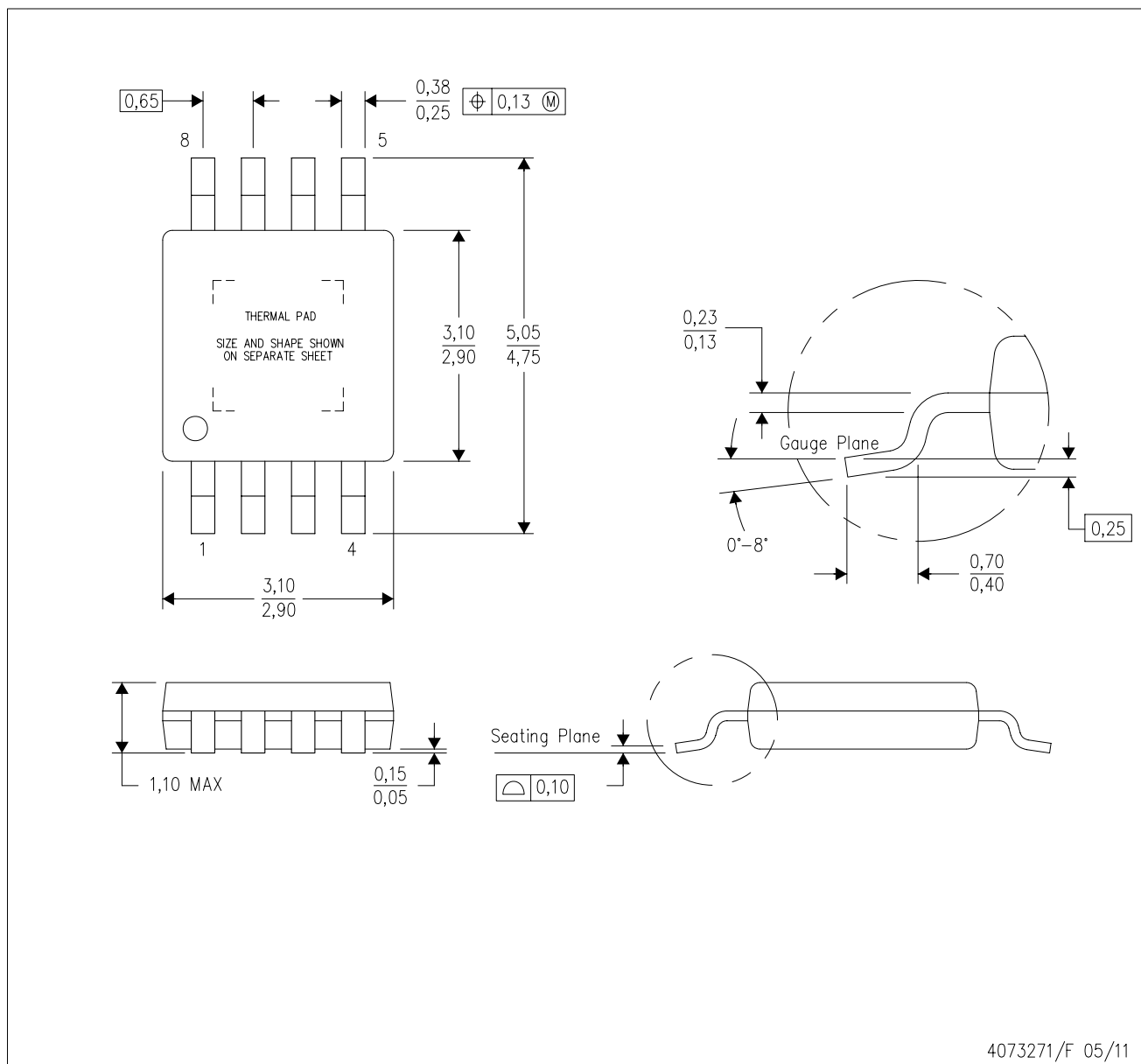

- NOTES:
- All linear dimensions are in millimeters.
 - This drawing is subject to change without notice.
 - Body dimensions do not include mold flash or protrusion.
 - This package is designed to be soldered to a thermal pad on the board. Refer to Technical Brief, PowerPad Thermally Enhanced Package, Texas Instruments Literature No. SLMA002 for information regarding recommended board layout. This document is available at www.ti.com <<http://www.ti.com>>.
 - See the additional figure in the Product Data Sheet for details regarding the exposed thermal pad features and dimensions.
 - Falls within JEDEC MO-187 variation AA-T

PowerPAD is a trademark of Texas Instruments.

D (R-PDSO-G8)

PLASTIC SMALL OUTLINE

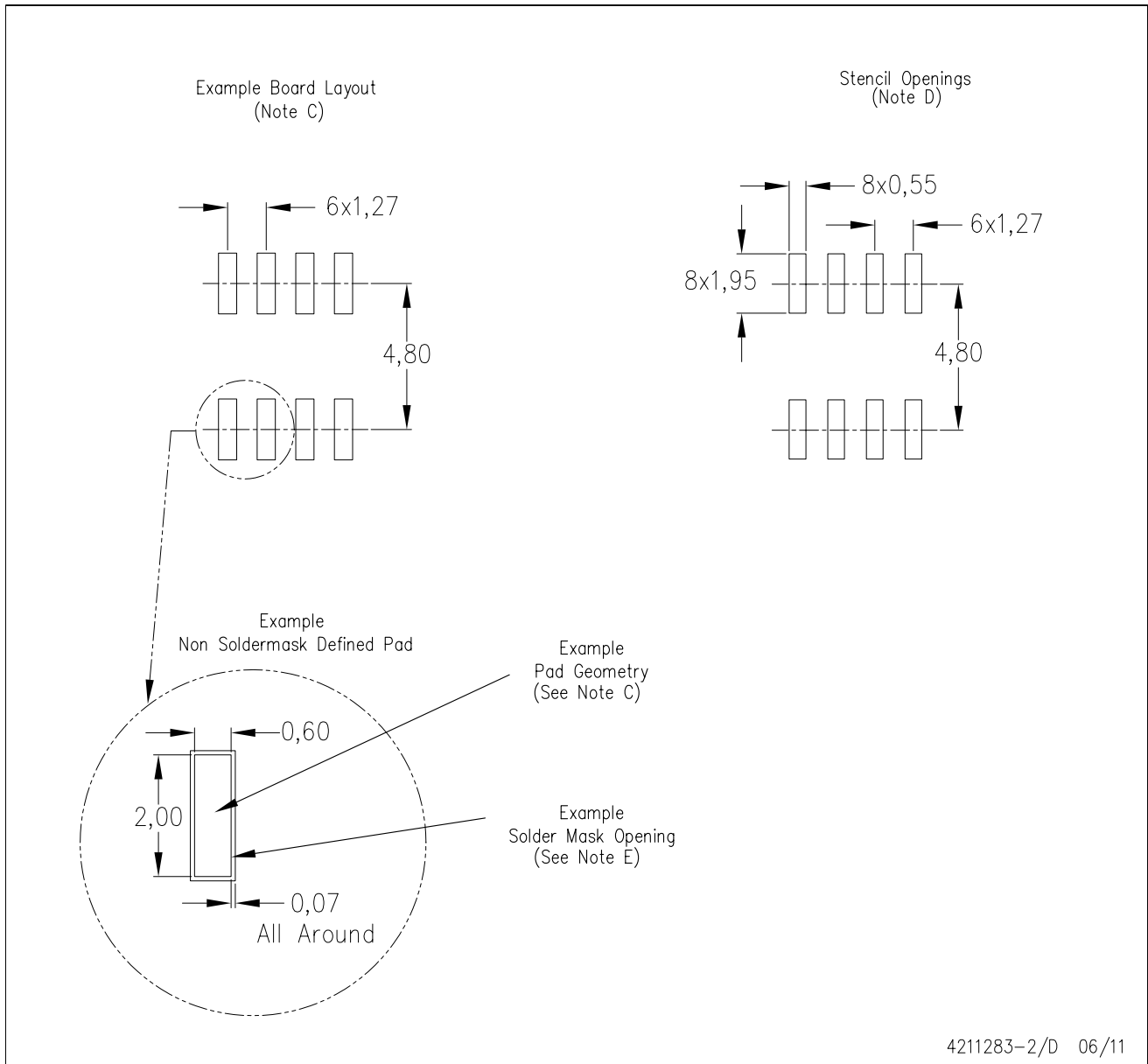

- NOTES:
- All linear dimensions are in millimeters.
 - This drawing is subject to change without notice.
 - Publication IPC-7351 is recommended for alternate designs.
 - Laser cutting apertures with trapezoidal walls and also rounding corners will offer better paste release. Customers should contact their board assembly site for stencil design recommendations. Refer to IPC-7525 for other stencil recommendations.
 - Customers should contact their board fabrication site for solder mask tolerances between and around signal pads.

IMPORTANT NOTICE

Texas Instruments Incorporated and its subsidiaries (TI) reserve the right to make corrections, modifications, enhancements, improvements, and other changes to its products and services at any time and to discontinue any product or service without notice. Customers should obtain the latest relevant information before placing orders and should verify that such information is current and complete. All products are sold subject to TI's terms and conditions of sale supplied at the time of order acknowledgment.

TI warrants performance of its hardware products to the specifications applicable at the time of sale in accordance with TI's standard warranty. Testing and other quality control techniques are used to the extent TI deems necessary to support this warranty. Except where mandated by government requirements, testing of all parameters of each product is not necessarily performed.

TI assumes no liability for applications assistance or customer product design. Customers are responsible for their products and applications using TI components. To minimize the risks associated with customer products and applications, customers should provide adequate design and operating safeguards.

TI does not warrant or represent that any license, either express or implied, is granted under any TI patent right, copyright, mask work right, or other TI intellectual property right relating to any combination, machine, or process in which TI products or services are used. Information published by TI regarding third-party products or services does not constitute a license from TI to use such products or services or a warranty or endorsement thereof. Use of such information may require a license from a third party under the patents or other intellectual property of the third party, or a license from TI under the patents or other intellectual property of TI.

Reproduction of TI information in TI data books or data sheets is permissible only if reproduction is without alteration and is accompanied by all associated warranties, conditions, limitations, and notices. Reproduction of this information with alteration is an unfair and deceptive business practice. TI is not responsible or liable for such altered documentation. Information of third parties may be subject to additional restrictions.

Resale of TI products or services with statements different from or beyond the parameters stated by TI for that product or service voids all express and any implied warranties for the associated TI product or service and is an unfair and deceptive business practice. TI is not responsible or liable for any such statements.

TI products are not authorized for use in safety-critical applications (such as life support) where a failure of the TI product would reasonably be expected to cause severe personal injury or death, unless officers of the parties have executed an agreement specifically governing such use. Buyers represent that they have all necessary expertise in the safety and regulatory ramifications of their applications, and acknowledge and agree that they are solely responsible for all legal, regulatory and safety-related requirements concerning their products and any use of TI products in such safety-critical applications, notwithstanding any applications-related information or support that may be provided by TI. Further, Buyers must fully indemnify TI and its representatives against any damages arising out of the use of TI products in such safety-critical applications.

TI products are neither designed nor intended for use in military/aerospace applications or environments unless the TI products are specifically designated by TI as military-grade or "enhanced plastic." Only products designated by TI as military-grade meet military specifications. Buyers acknowledge and agree that any such use of TI products which TI has not designated as military-grade is solely at the Buyer's risk, and that they are solely responsible for compliance with all legal and regulatory requirements in connection with such use.

TI products are neither designed nor intended for use in automotive applications or environments unless the specific TI products are designated by TI as compliant with ISO/TS 16949 requirements. Buyers acknowledge and agree that, if they use any non-designated products in automotive applications, TI will not be responsible for any failure to meet such requirements.

Following are URLs where you can obtain information on other Texas Instruments products and application solutions:

Products

Audio	www.ti.com/audio
Amplifiers	amplifier.ti.com
Data Converters	dataconverter.ti.com
DLP® Products	www.dlp.com
DSP	dsp.ti.com
Clocks and Timers	www.ti.com/clocks
Interface	interface.ti.com
Logic	logic.ti.com
Power Mgmt	power.ti.com
Microcontrollers	microcontroller.ti.com
RFID	www.ti-rfid.com
OMAP Mobile Processors	www.ti.com/omap
Wireless Connectivity	www.ti.com/wirelessconnectivity

Applications

Communications and Telecom	www.ti.com/communications
Computers and Peripherals	www.ti.com/computers
Consumer Electronics	www.ti.com/consumer-apps
Energy and Lighting	www.ti.com/energy
Industrial	www.ti.com/industrial
Medical	www.ti.com/medical
Security	www.ti.com/security
Space, Avionics and Defense	www.ti.com/space-avionics-defense
Transportation and Automotive	www.ti.com/automotive
Video and Imaging	www.ti.com/video

TI E2E Community Home Page

e2e.ti.com

Mailing Address: Texas Instruments, Post Office Box 655303, Dallas, Texas 75265
Copyright © 2011, Texas Instruments Incorporated

www.BDTIC.com/TI