

Features

- For EGSM applications
- Usable bandwidth 35 MHz
- Low loss
- No impedance matching required for operation at 50 Ω
- Single-ended operation
- Ceramic Surface Mount Package (SMP)
- Small Size
- Hermetic
- RoHS compliant (2002/95/EC), Pb-free 

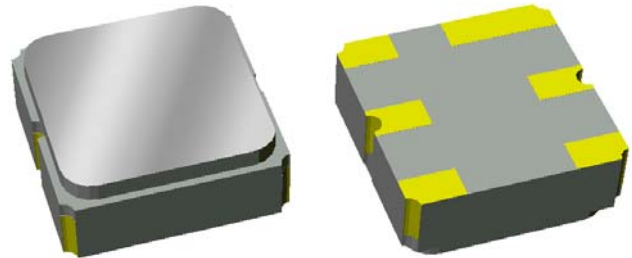

Package

Surface Mount 3.00 x 3.00 x 1.22 mm
SMP-12

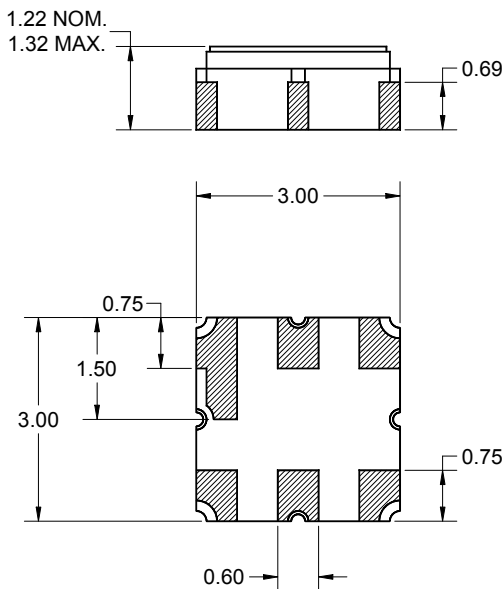

Pin Configuration

Bottom View

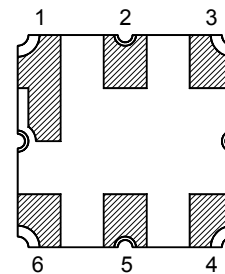

Single-ended Configuration

Pin No.	Description
2	Input
5	Output
1,3,4,6	Case ground

Dimensions shown are nominal in millimeters
All tolerances are ±0.15mm except overall length and width ±0.10mm

Body: Al₂O₃ ceramic
Lid: Kovar, Ni plated
Terminations: Au plating 0.5 - 1.0µm, over a 2 - 6µm Ni plating

Electrical Specifications ⁽¹⁾

Operating Temperature Range: ⁽²⁾ -20 to +70 °C

Parameter ⁽³⁾	Minimum	Typical ⁽⁴⁾	Maximum	Unit
Center Frequency	-	942.5	-	MHz
Insertion Loss				
925 - 960 MHz (+15 to +35 °C)	-	2	3.2	dB
925 - 960 MHz (-20 to +70 °C)	-	2.2	4	dB
Absolute Attenuation				
10 - 905 MHz	20	32	-	dB
905 - 915 MHz (-20 to +35 °C)	12	18	-	dB
905 - 915 MHz (+35 to +70 °C)	5	18	-	dB
980 - 2400 MHz	20	28	-	dB
2400 - 3120 MHz	10	26	-	dB
Input/Output Return Loss				
925 - 960 MHz	6	10	-	dB
Source Impedance (single-ended) ⁽⁵⁾	-	50	-	Ω
Load Impedance (single-ended) ⁽⁵⁾	-	50	-	Ω

Notes:

1. All specifications are based on the TriQuint test circuit shown below
2. In production, devices will be tested at room temperature to a guardbanded specification to ensure electrical compliance over temperature
3. Electrical margin has been built into the design to account for the variations due to temperature drift and manufacturing tolerances
4. Typical values are based on average measurements at room temperature
5. This is the optimum impedance in order to achieve the performance shown

Test Circuit:

Actual matching values may vary due to PCB layout and parasitics

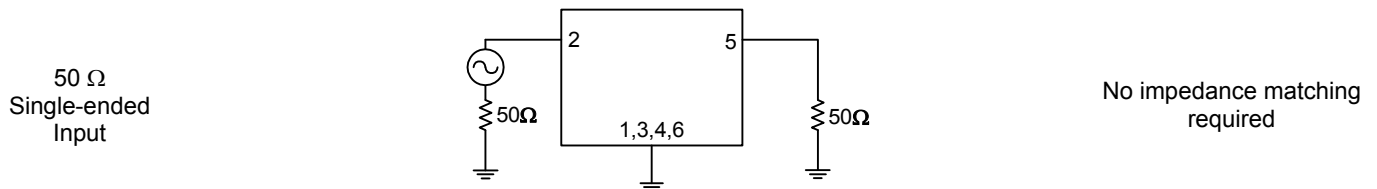

Electrical Specifications ⁽¹⁾

Operating Temperature Range: ⁽²⁾ -40 to +85 °C

Parameter ⁽³⁾	Minimum	Typical ⁽⁴⁾	Maximum	Unit
Center Frequency	-	942.5	-	MHz
Insertion Loss 925 - 960 MHz	-	2.5	4.5	dB
Absolute Attenuation 10 - 905 MHz	20	32	-	dB
905 - 915 MHz (-40 to +35 °C)	12	18	-	dB
905 - 915 MHz (+35 to +85 °C)	4	18	-	dB
980 - 2400 MHz	20	28	-	dB
2400 - 3120 MHz	10	26	-	dB
Input/Output Return Loss 925 - 960 MHz	6	10	-	dB
Source Impedance (single-ended) ⁽⁵⁾	-	50	-	Ω
Load Impedance (single-ended) ⁽⁵⁾	-	50	-	Ω

Notes:

1. All specifications are based on the TriQuint test circuit shown below
2. In production, devices will be tested at room temperature to a guardbanded specification to ensure electrical compliance over temperature
3. Electrical margin has been built into the design to account for the variations due to temperature drift and manufacturing tolerances
4. Typical values are based on average measurements at room temperature
5. This is the optimum impedance in order to achieve the performance shown

Test Circuit:

Actual matching values may vary due to PCB layout and parasitics

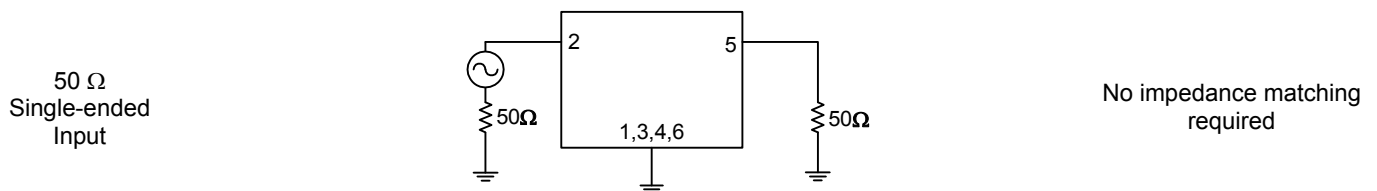

Typical Performance (at room temperature)

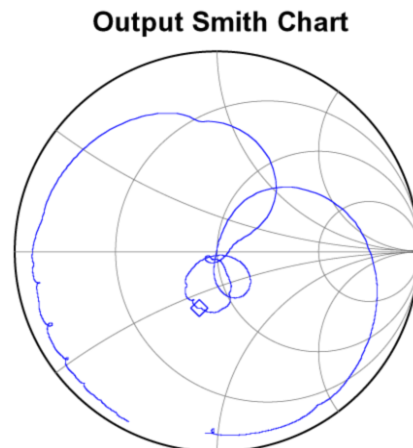
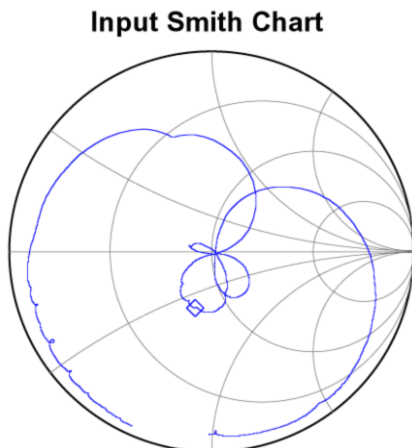
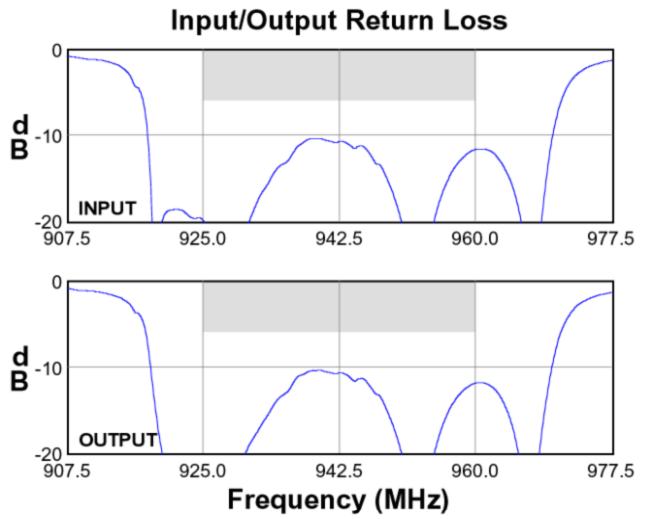
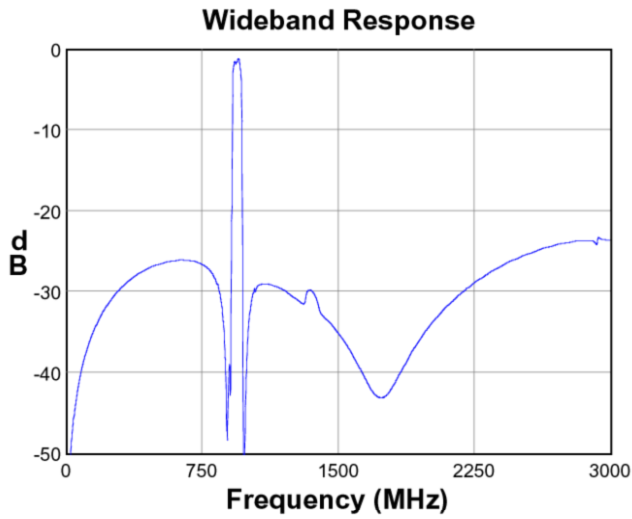
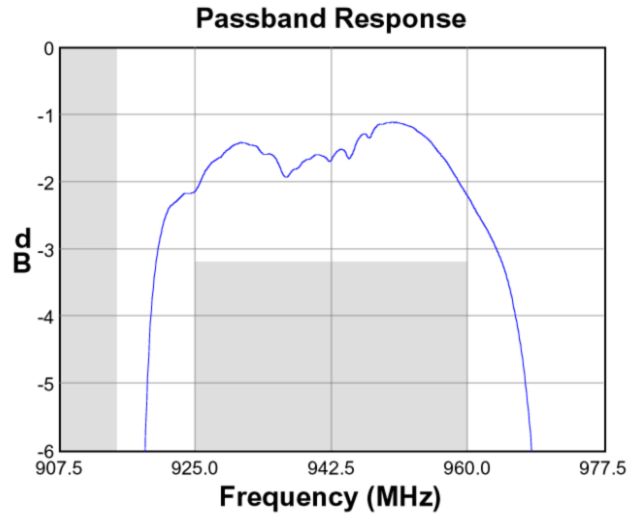
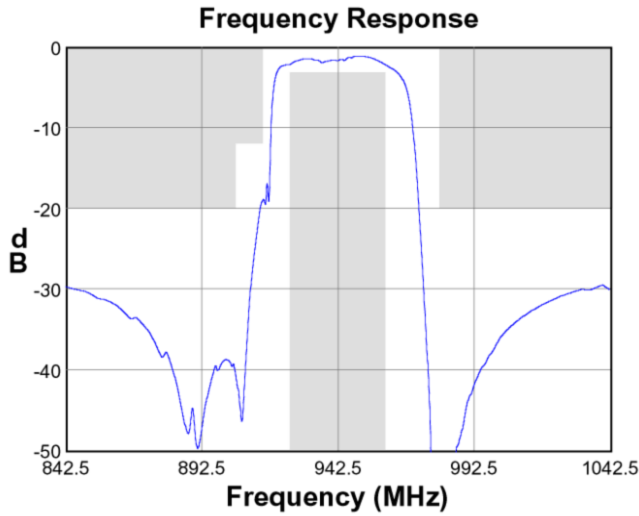

Matching Schematics

Actual matching values may vary due to PCB layout and parasitics

50 Ω
Single-ended
Input

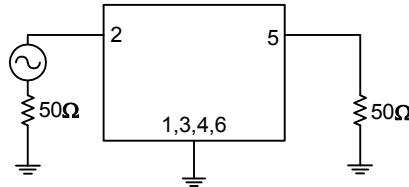

No impedance matching
required

Marking

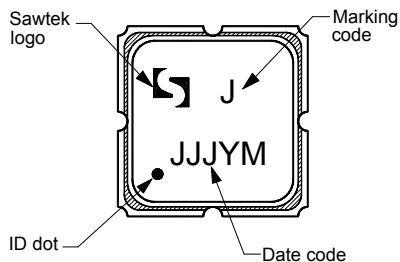

The date code consists of: day of the current year (Julian, 3 digits), last digit of the year (1 digit) and hour (2 digits)

PCB Footprint

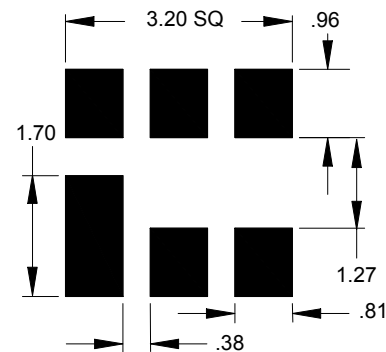

This footprint represents a recommendation only
Dimensions shown are nominal in millimeters

Tape and Reel

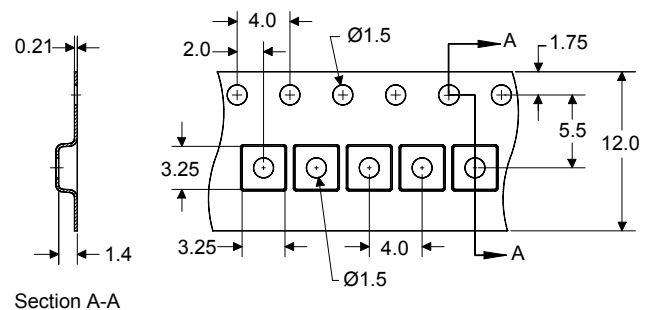
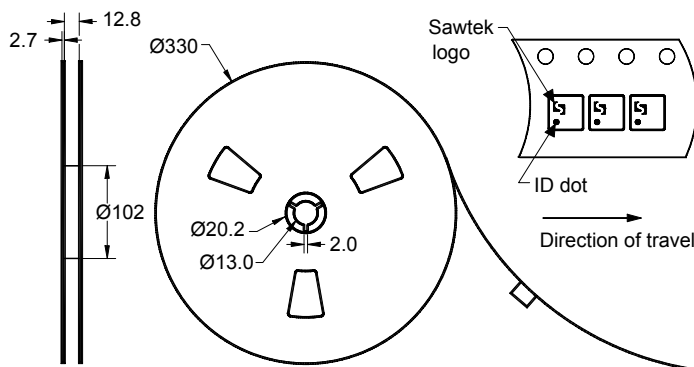

Dimensions shown are nominal in millimeters
Packaging quantity: 5000 units/reel

Maximum Ratings

Parameter	Symbol	Minimum	Maximum	Unit
Operating Temperature Range	T	-40	+85	°C
Storage Temperature Range	T _{stg}	-40	+85	°C
Input Power (2:8 duty cycle, 20,000 hours @55°C)	P _{in}		+16	dBm

Important Notes

Warnings

- Electrostatic Sensitive Device (ESD) 
- Avoid ultrasonic exposure

RoHS Compliance

- This product complies with EU directive 2002/95/EC (RoHS) 

Solderability

- Compatible with JESD22-B102, Pb-free process, 260C peak reflow temperature ([see soldering profile](#))

Links to Additional Technical Information

[PCB Layout Tips](#)

[Qualification Flowchart](#)

[Soldering Profile](#)

[S-Parameters](#)

[RoHS Information](#)

[Other Technical Information](#)

TriQuint's liability is limited only to the Surface Acoustic Wave (SAW) component(s) described in this data sheet. TriQuint does not accept any liability for applications, processes, circuits or assemblies, which are implemented using any TriQuint component described in this data sheet.

Contact Information

TriQuint 
SEMICONDUCTOR

PO Box 609501
Orlando, FL 32860-9501
USA

Phone: +1 (407) 886-8860
Fax: +1 (407) 886-7061
Email: info-product@tqs.com
Web: www.triquint.com

Or contact one of our worldwide
Network of [sales offices](#),
[Representatives or distributors](#)