

2 - 18 GHz Low Noise Amplifier

TGA8344-SCC

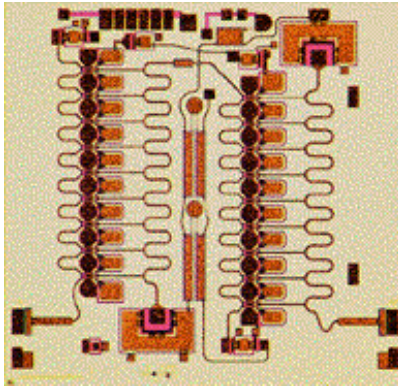

Key Features and Performance

- 2 to 18 GHz Frequency Range
- Typical 4 dB Noise Figure at Midband
- 16 dBm Typical Output Power at 1 dB Gain Compression
- 19 dB Typical Gain
- Typical Input SWR 1.5:1 and Output SWR 1.6:1
- 3.9878 x 3.810 x 0.1016 mm (0.1570 x 0.150 x 0.0040 in.)

Description

The TriQuint TGA8344-SCC features two cascaded monolithic low-noise distributed amplifiers with on-chip bias operating from 2 to 18 GHz. This die offers the advantage of high gain, typically 19 dB, in compact die size with simplified biasing configuration. Noise figure is typically 4 dB. The two cascade amplifiers have eighteen 122 um gatewidth FETs providing 16 dBm of output power at 1 dB gain compression. Input return loss is typically 14 dB from 2 to 18 GHz and output return loss is typically 13 dB. Ground is provided to the circuitry through vias to the backside metallization. The TGA8344-SCC small size and high gain make it suitable for use in a variety of wide-band electronic commercial and warfare systems.

Bond pad and backside metallization is gold plated for compatibility with eutectic alloy attachment methods as well as the thermocompression wire-bonding processes. The TGA8344-SCC is supplied in chip form and is readily assembled using automated equipment.

**TYPICAL
SMALL-SIGNAL
POWER GAIN**

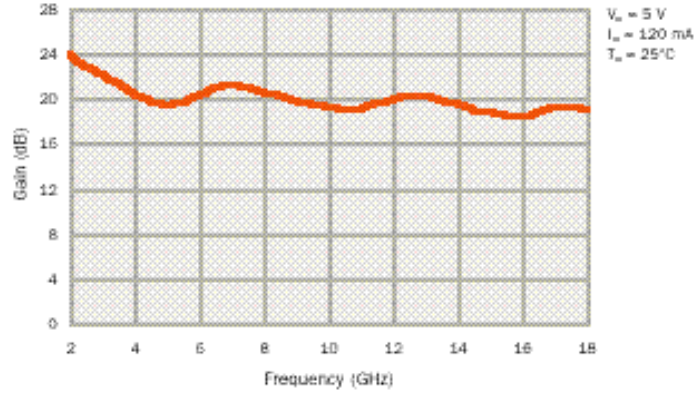

**TYPICAL
NOISE FIGURE**

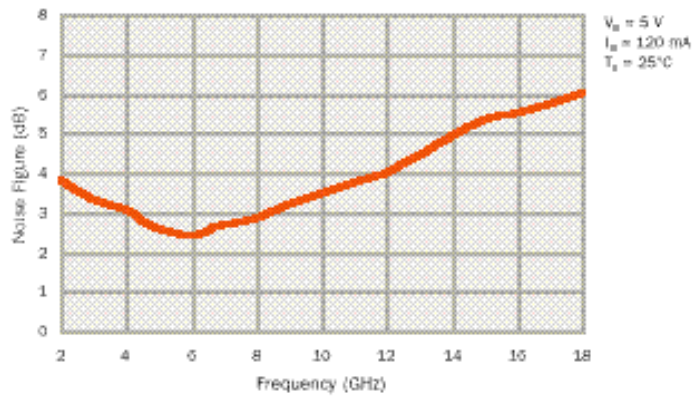

**TYPICAL
OUTPUT POWER
P_{1dB}**

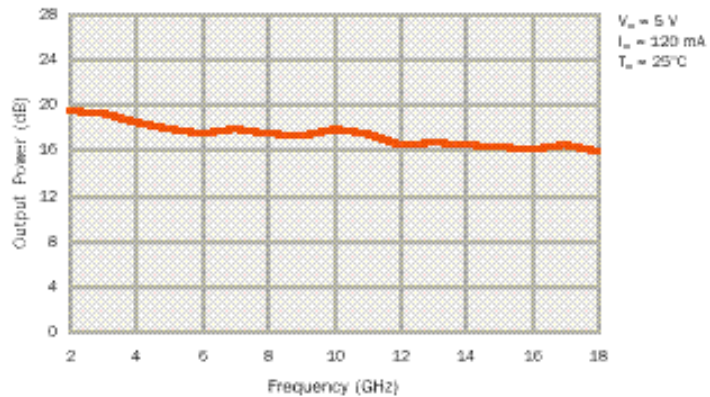

**TYPICAL
RETURN LOSS**

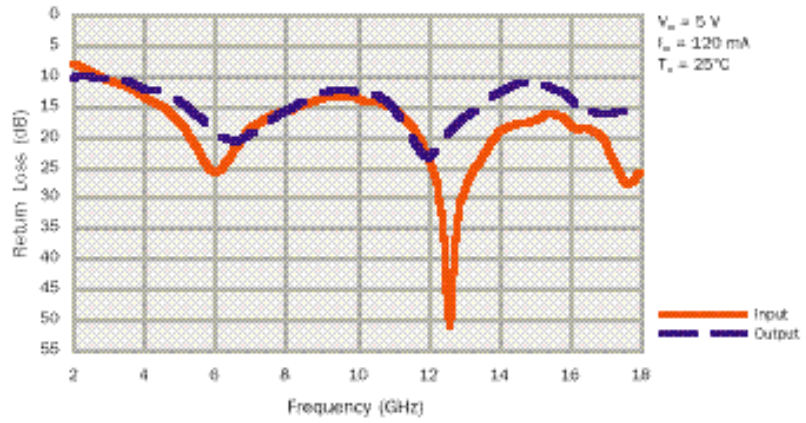

TABLE I
MAXIMUM RATINGS

SYMBOL	PARAMETER	VALUE
V_D	DRAIN SUPPLY VOLTAGE	9V
V^+	POSITIVE SUPPLY VOLTAGE	12V
$V^+ - V^-$	POSITIVE SUPPLY VOLTAGE RANGE WITH RESPECT TO NEGATIVE SUPPLY VOLTAGE	0V to 13V
$V_{CTRL} - V^+$	POSITIVE SUPPLY VOLTAGE WITH RESPECT TO GAIN CONTROL VOLTAGE	0V to -13V
V^-	NEGATIVE SUPPLY VOLTAGE RANGE	-5V to 0V
V_{CTRL}	GAIN CONTROL VOLTAGE RANGE	-5V to 4V
I^+	POSITIVE SUPPLY CURRENT	376mA
I^-	NEGATIVE SUPPLY CURRENT	-8.73mA
P_D	POWER DISSIPATION, AT (OR BELOW) 25°C BASE-PLATE TEMPERATURE *	5.3W
P_{IN}	INPUT CONTINUOUS WAVE POWER	23dBm
T_{CH}^{**}	OPERATING CHANNEL TEMPERATURE	150 °C
T_M	MOUNTING TEMPERATURE (30 SECONDS)	320 °C
T_{STG}	STORAGE TEMPERATURE	-65 to 150 °C

Ratings over channel temperature range, T_{CH} (unless otherwise noted)

Stresses beyond those listed under “Maximum Ratings” may cause permanent damage to the device.

These are stress ratings only, and functional operation of the device at these or any other conditions beyond those indicated under “RF Specifications” is not implied. Exposure to maximum rated conditions for extended periods may affect device reliability.

*For operation above 25°C base-plate temperature, derate linearly at the rate of 11.2mW/°C.

** Operating channel temperature, T_{CH} , directly affects the device MTTF. For maximum life, it is recommended that channel temperature be maintained at the lowest possible level.

TABLE II
DC PROBE TESTS (100%)
(T_A = 25 °C Nominal)

NOTES	SYMBOL	TEST CONDITIONS <u>3/</u>	LIMITS		UNITS
			MIN	MAX	
<u>2/</u>	I _{DSS1-9}	STD	110	307	mA
<u>2/</u>	G _{M1-9}	STD	186	340	mS
<u>1/</u> , <u>2/</u>	V _{BVGS1-9}	STD	6	30	V
<u>1/</u> , <u>2/</u>	V _{P1-9, 1}	STD	0.5	1.8	V
<u>1/</u> , <u>2/</u>	V _{P1-9, 2}	STD	0.5	1.8	V
<u>1/</u> , <u>2/</u>	V _{P10-18, 1}	STD	0.5	1.8	V
<u>1/</u> , <u>2/</u>	V _{P10-18, 2}	STD	0.5	1.8	V

- 1/ V_{BVGS1-9}, V_{P1-9}, and V_{P10-18} are negative
- 2/ Subscripts are referred to Q1 through Q18 accordingly.
- 3/ The measurement conditions are subject to change at the manufacturer's discretion (with appropriate notification to the buyer).

STD – Standard Test Conditions (see Table IV for definitions)

TABLE III
RF CHARACTERISTICS
(T_A = 25°C Nominal)

NOTE	TEST	MEASUREMENT CONDITIONS V _D = 8V, I ⁺ = 120 ± 5% mA ^{1/}	VALUE		UNITS
			MIN	MAX	
<u>2/</u>	SMALL-SIGNAL GAIN MAGNITUDE	2 – 18 GHz	14		dB
<u>2/</u>	POWER OUTPUT AT 1 dB GAIN COMPRESSION	2 – 16 GHz	13		dBm
		18 GHz	12		dBm
<u>2/</u>	INPUT RETURN LOSS MAGNITUDE	2 – 18 GHz		-7.7	dB
<u>2/</u>	OUTPUT RETURN LOSS MAGNITUDE	2 – 18 GHz		-7.7	dB
<u>2/</u>	NOISE FIGURE	2 – 14 GHz		5.7	dB
		16 – 18 GHz		7	dB

1/ V_{G2} (approximately 1.5V) is provided through an on chip voltage divider.

2/ RF probe data is taken at 2 GHz steps

Table IV
AUTOPROBE FET PARAMETER MEASUREMENT CONDITIONS

FET Parameters	Test Conditions
I_{DSS} : Maximum drain current (I _{DS}) with gate voltage (V _{GS}) at zero volts.	V _{GS} = 0.0 V, drain voltage (V _{DS}) is swept from 0.5 V up to a maximum of 3.5 V in search of the maximum value of I _{DS} ; voltage for I _{DSS} is recorded as VDSP.
G_m : Transconductance; $\frac{(I_{DSS} - IDS1)}{VG1}$	For all material types, V _{DS} is swept between 0.5 V and VDSP in search of the maximum value of I _{ds} . This maximum I _{DS} is recorded as IDS1. For Intermediate and Power material, IDS1 is measured at V _{GS} = VG1 = -0.5 V. For Low Noise, HFET and pHEMT material, V _{GS} = VG1 = -0.25 V. For LNBECOLC, use V _{GS} = VG1 = -0.10 V.
V_P : Pinch-Off Voltage; V _{GS} for I _{DS} = 0.5 mA/mm of gate width.	V _{DS} fixed at 2.0 V, V _{GS} is swept to bring I _{DS} to 0.5 mA/mm.
V_{BVGD} : Breakdown Voltage, Gate-to-Drain; gate-to-drain breakdown current (I _{BD}) = 1.0 mA/mm of gate width.	Drain fixed at ground, source not connected (floating), 1.0 mA/mm forced into gate, gate-to-drain voltage (V _{GD}) measured is V _{BDGD} and recorded as BVGD; this cannot be measured if there are other DC connections between gate-drain, gate-source or drain-source.
V_{BVGS} : Breakdown Voltage, Gate-to-Source; gate-to-source breakdown current (I _{BS}) = 1.0 mA/mm of gate width.	Source fixed at ground, drain not connected (floating), 1.0 mA/mm forced into gate, gate-to-source voltage (V _{GS}) measured is V _{BDGS} and recorded as BVGS; this cannot be measured if there are other DC connections between gate-drain, gate-source or drain-source.

TYPICAL S-PARAMETERS

Frequency (GHz)	S ₁₁		S ₂₁		S ₁₂		S ₂₂		GAIN (dB)
	MAG	ANG(°)	MAG	ANG(°)	MAG	ANG(°)	MAG	ANG(°)	
1.0	0.63	-79	22.70	38	0.000	155	0.32	118	27.1
1.4	0.52	-103	20.49	-46	0.000	-153	0.27	24	26.2
1.8	0.43	-123	16.92	-95	0.001	157	0.30	-24	24.6
2.2	0.37	-140	15.01	-133	0.001	134	0.31	-57	23.5
2.6	0.33	-158	13.76	-167	0.001	114	0.31	-85	22.8
3.0	0.29	-175	12.85	161	0.001	111	0.30	-110	22.2
3.4	0.26	167	12.00	130	0.001	105	0.28	-135	21.6
3.8	0.23	147	11.03	100	0.001	109	0.26	-160	20.8
4.2	0.20	130	10.32	73	0.002	90	0.24	-180	20.3
4.6	0.17	109	9.68	47	0.001	59	0.22	151	19.7
5.0	0.13	86	9.45	23	0.001	71	0.19	124	19.5
5.4	0.09	57	9.69	-2	0.001	115	0.16	94	19.7
5.8	0.06	11	10.25	-28	0.001	149	0.12	58	20.2
6.2	0.05	-59	10.89	-57	0.001	159	0.10	15	20.7
6.6	0.08	-109	11.36	-88	0.002	155	0.09	-38	21.1
7.0	0.11	-139	11.51	-119	0.003	141	0.10	-83	21.2
7.4	0.14	-162	11.36	-150	0.003	131	0.13	-115	21.1
7.8	0.16	179	10.94	180	0.003	112	0.15	-140	20.8
8.2	0.16	166	10.56	151	0.004	103	0.17	-159	20.5
8.6	0.18	155	10.29	122	0.003	89	0.20	-176	20.2
9.0	0.20	140	9.94	93	0.002	74	0.23	165	20.0
9.4	0.21	123	9.55	66	0.001	84	0.24	145	19.6
9.8	0.21	107	9.34	38	0.001	109	0.24	126	19.4
10.2	0.20	92	9.19	11	0.001	155	0.23	105	19.3
10.6	0.19	74	9.00	-16	0.001	153	0.21	83	19.1
11.0	0.17	56	9.16	-42	0.002	-174	0.17	56	19.2
11.4	0.13	38	9.53	-70	0.003	-178	0.12	22	19.6
11.8	0.09	18	9.84	-99	0.004	166	0.07	-25	19.9
12.2	0.05	-8	10.28	-130	0.004	155	0.08	-92	20.2
12.6	0.00	-131	10.41	-162	0.004	143	0.11	-140	20.3
13.0	0.03	143	10.38	166	0.004	127	0.14	-165	20.3
13.4	0.06	132	10.15	134	0.003	119	0.17	176	20.1
13.8	0.09	126	9.72	102	0.002	97	0.21	160	19.7
14.2	0.12	104	9.35	72	0.001	78	0.25	140	19.4
14.6	0.13	91	8.86	42	0.000	-93	0.27	117	18.9
15.0	0.14	80	8.69	13	0.001	-96	0.27	93	18.8
15.4	0.15	65	8.54	-17	0.002	-94	0.25	65	18.6
15.8	0.14	43	8.44	-47	0.004	-90	0.23	32	18.5
16.2	0.11	32	8.45	-76	0.008	-120	0.18	-6	18.5
16.6	0.11	11	9.00	-107	0.009	-153	0.16	-50	19.1
17.0	0.09	-28	9.26	-142	0.008	-179	0.16	-101	19.3
17.4	0.05	-84	9.25	-176	0.008	159	0.16	-144	19.3

$$V_D = 5 \text{ V}, I_D = 120 \text{ mA}, T_A = 25^\circ\text{C}$$

The reference planes for S-parameter data include bond wires as specified in the "Recommended Assembly Diagram." The S-parameters are also available on floppy disk and the world wide web.

THERMAL DATA

	PARAMETER	TEST CONDITIONS	FET	MMIC	UNIT
$R_{\theta JC}$	Thermal resistance, channel-to-backside	25°C Base, 31.83°C Channel†, $I_D = 0.12$ A, $V = 5$, $P_D = 0.6$ W**	205	11.4	°C/W
$R_{\theta JC}$	Thermal resistance, channel-to-backside	100°C Base, 108.6°C Channel†, $I_D = 0.12$ A, $V = 5$, $P_D = 0.6$ W**	258	14.4	°C/W

* Center of FET of either TGA8344 half-amplifier.

** Total power dissipation for TGA8344: divide by 18 to obtain the single-FET power dissipation.

EQUIVALENT SCHEMATIC

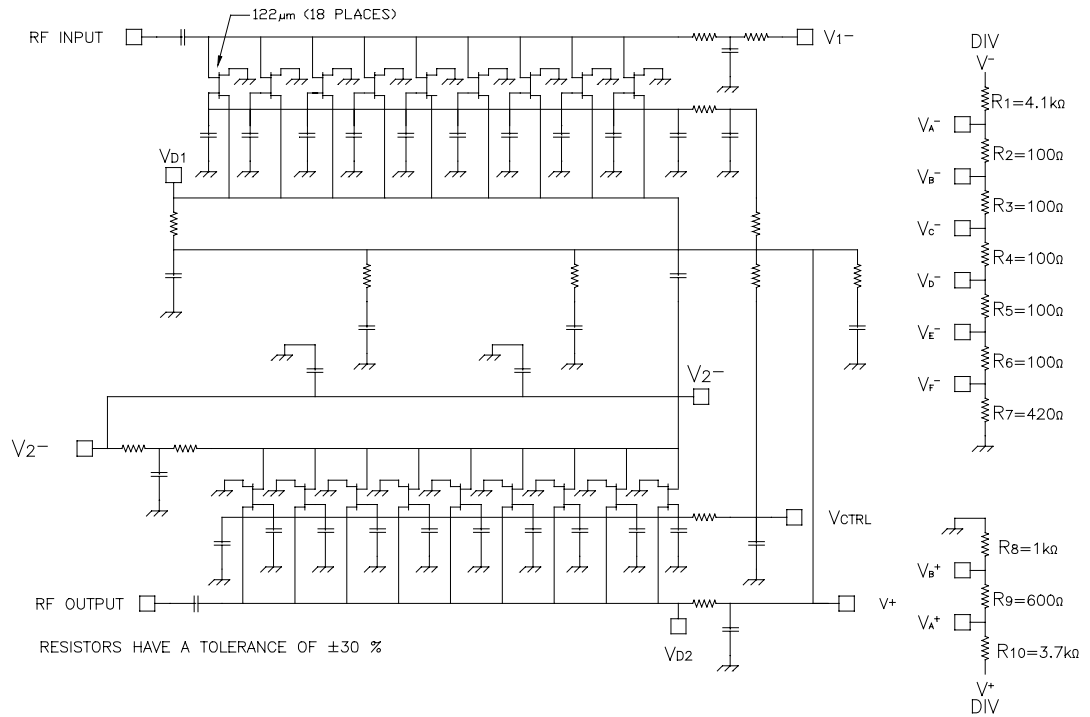

**RECOMMENDED
ASSEMBLY
DIAGRAM**

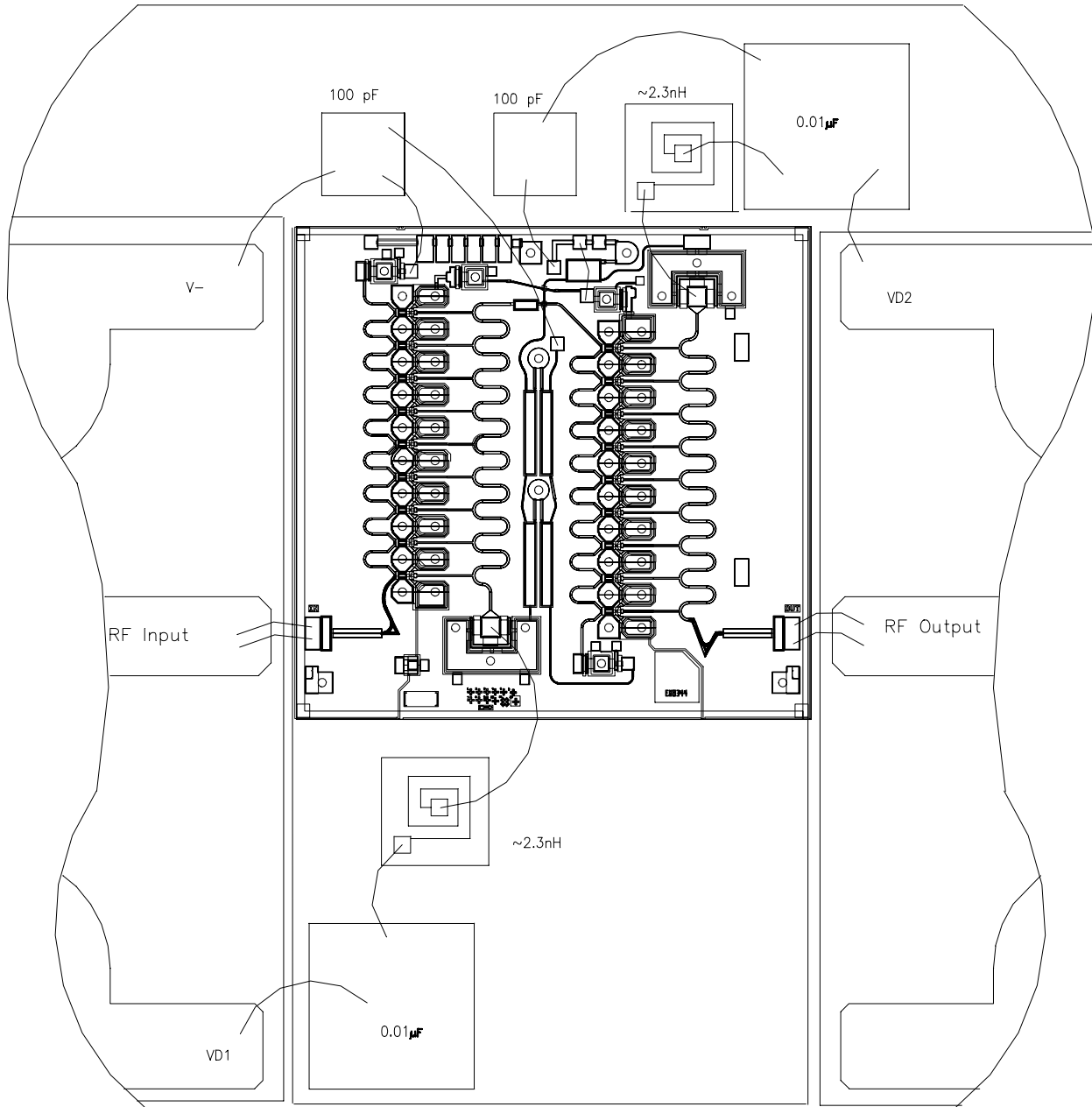

RF connections: Bond using two 1.0-mil diameter, 20 to 30-mil-length gold bond wires at both RF Input and RF Output for optimum RF performance.

$V- = V_1 - = V_2 -$

Two on-chip to on-chip wire bonds are needed for bond pads 3 and 13.

Close placement of external components is essential to stability.

Refer to TriQuint's Gallium Arsenide Products Designers' Information on our website under Application Information.

**MECHANICAL
DRAWING**

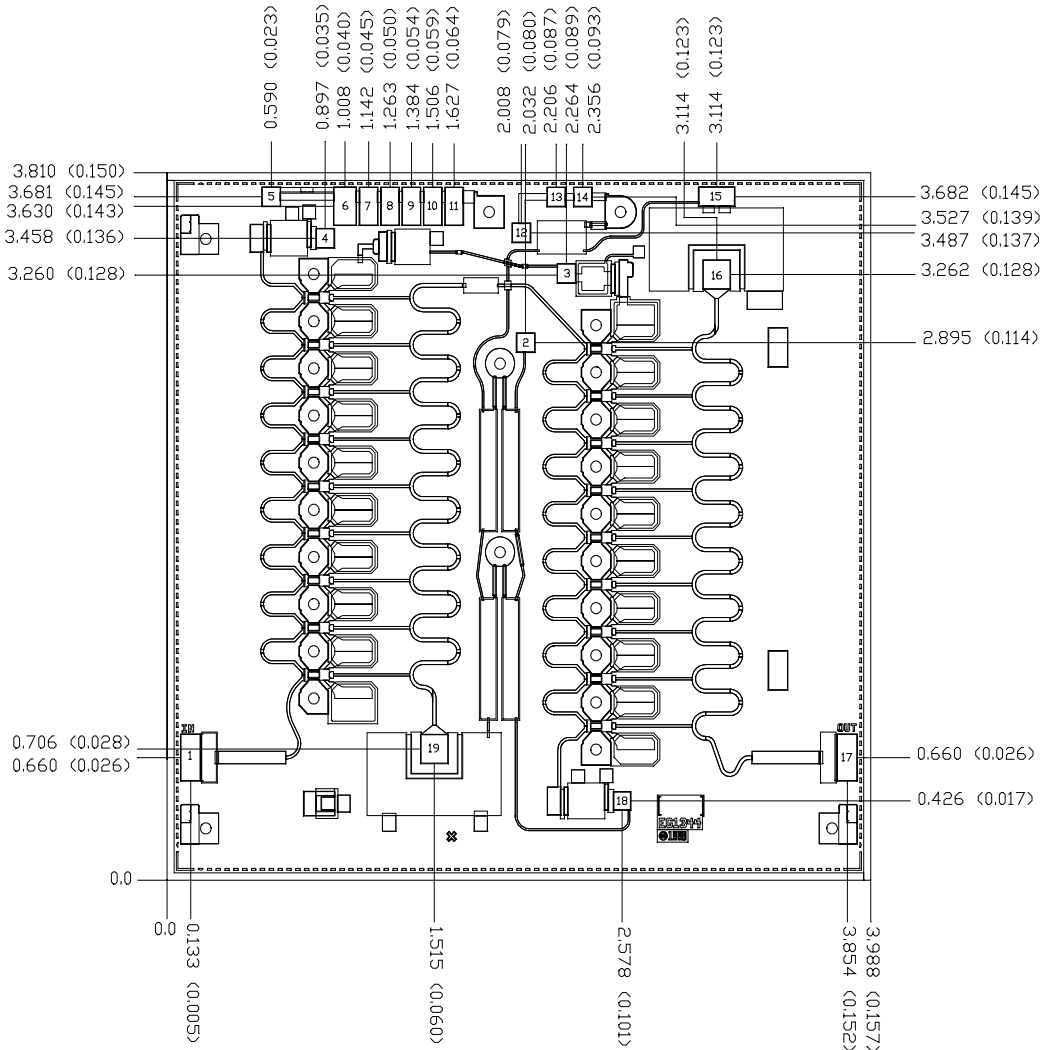

Units: millimeters (inches)
 Thickness: 0.1016 (0.004)
 Chip edge to bond pad dimensions are shown to center of bond pad
 Chip size tolerance: +/- 0.051 (0.002)

Bond Pad #1 (RF Input)	0.109 x 0.249 (0.004 x 0.010)	Bond Pad #11 (VF-)	0.102 x 0.203 (0.004 x 0.008)
Bond Pad #2 (V2-)	0.102 x 0.102 (0.004 x 0.004)	Bond Pad #12 (Vdiv+)	0.102 x 0.102 (0.004 x 0.004)
Bond Pad #3 (Vctrl)	0.102 x 0.102 (0.004 x 0.004)	Bond Pad #13 (VA+)	0.102 x 0.102 (0.004 x 0.004)
Bond Pad #4 (V1-)	0.102 x 0.102 (0.004 x 0.004)	Bond Pad #14 (VB+)	0.102 x 0.102 (0.004 x 0.004)
Bond Pad #5 (Vdiv-)	0.102 x 0.102 (0.004 x 0.004)	Bond Pad #15 (V+)	0.102 x 0.203 (0.004 x 0.008)
Bond Pad #6 (VA-)	0.127 x 0.203 (0.005 x 0.008)	Bond Pad #16 (VD2)	0.157 x 0.158 (0.006 x 0.006)
Bond Pad #7 (VB-)	0.102 x 0.203 (0.004 x 0.008)	Bond Pad #17 (RF Output)	0.109 x 0.249 (0.004 x 0.010)
Bond Pad #8 (VC-)	0.102 x 0.203 (0.004 x 0.008)	Bond Pad #18 (V2-)	0.097 x 0.097 (0.0003 x 0.0003)
Bond Pad #9 (VD-)	0.102 x 0.203 (0.004 x 0.008)	Bond Pad #19 (VD1)	0.157 x 0.158 (0.006 x 0.006)
Bond Pad #10 (VE-)	0.102 x 0.203 (0.004 x 0.008)		

GaAs MMIC devices are susceptible to damage from Electrostatic Discharge. Proper precautions should be observed during handling, assembly and test.