

FEATURES

- Programmable Charge Current Up to 900mA
- Charge Current Monitor Output for Charge Termination*
- Constant-Current/Constant-Voltage Operation with Thermal Regulation to Maximize Charging Rate Without Risk of Overheating*
- Constant-Current Source Mode for Charging Nickel Batteries (LTC4059 Only)
- ACPR Pin Indicates Presence of Input Supply (LTC4059A Only)
- No External MOSFET, Sense Resistor or Blocking Diode Required
- Operating Supply Voltage from 3.75V to 8V
- Charges Single Cell Li-Ion Batteries Directly from USB Port
- Preset 4.2V Charge Voltage with 0.6% Accuracy
- 10 μ A Supply Current in Shutdown Mode
- Tiny 6-Lead (2mm × 2mm) DFN Package

APPLICATIONS

- Wireless PDAs
- Cellular Phones
- Portable Electronics
- Wireless Headsets
- Digital Cameras

DESCRIPTION

The LTC[®]4059/LTC4059A are constant-current/constant-voltage linear chargers for single cell lithium-ion batteries. Their 2mm × 2mm DFN package and low external component count make these chargers especially well suited for portable applications. Furthermore, they are designed to work within USB power specifications.

No external sense resistor, MOSFET or blocking diode is required. Thermal feedback regulates the charge current to limit the die temperature during high power operation or high ambient thermal conditions. The charge voltage is fixed at 4.2V and the charge current is programmable.

When the input supply (wall adapter or USB supply) is removed, the LTC4059/LTC4059A automatically enter a low current state, dropping the battery current drain to less than 1 μ A. With power applied, they can be put into shutdown mode, reducing the supply current to 10 μ A.

The LTC4059A features an open-drain status pin to indicate the presence of an input voltage. The LTC4059 can be used as a constant-current source to charge Nickel cells. Other features include undervoltage lockout protection and a current monitor pin which can indicate when to terminate a charge cycle.

The LTC4059/LTC4059A are available in a 6-lead, low profile (0.8mm) 2mm × 2mm DFN package.

LT, LTC and LT are registered trademarks of Linear Technology Corporation.
 *US Patent 6,522,118

TYPICAL APPLICATION

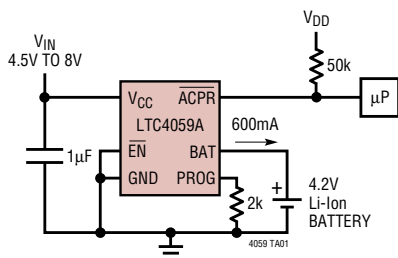

Complete Charge Cycle (800mAh Battery)

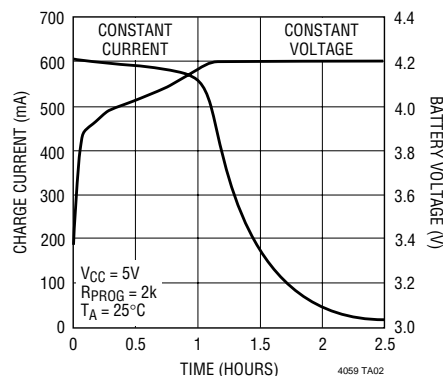

4059fa

ABSOLUTE MAXIMUM RATINGS

(Note 1)

Input Supply Voltage (V_{CC})	-0.3V to 10V
BAT, PROG, \overline{EN} , $L_{i}CC$, ACPR	-0.3V to 10V
BAT Short-Circuit Duration	Continuous
BAT Pin Current	1000mA
PROG Pin Current	1000 μ A
Junction Temperature	125°C
Operating Temperature Range (Note 2)	-40°C to 85°C
Storage Temperature Range	-65°C to 125°C

PACKAGE/ORDER INFORMATION

<p>DC6 PACKAGE 6-LEAD (2mm × 2mm) PLASTIC DFN $T_{JMAX} = 125^{\circ}C$, $\theta_{JA} = 60^{\circ}C/W$ TO $85^{\circ}C/W$ (NOTE 3) *$L_{i}CC$ PIN 2 ON LTC4059EDC, ACPR PIN 2 ON LTC4059AEDC EXPOSED PAD IS GND (PIN 7) MUST BE SOLDERED TO PCB</p>	ORDER PART NUMBER
	LTC4059EDC LTC4059AEDC
	DC6 PART MARKING
	LAFU LBJH

Consult LTC Marketing for parts specified with wider operating temperature ranges.

ELECTRICAL CHARACTERISTICS

The ● denotes the specifications which apply over the full operating temperature range, otherwise specifications are at $T_A = 25^{\circ}C$. $V_{CC} = 5V$ unless otherwise noted.

SYMBOL	PARAMETER	CONDITIONS	MIN	TYP	MAX	UNITS
V_{CC}	V_{CC} Supply Voltage		● 3.75		8	V
I_{CC}	Quiescent V_{CC} Supply Current	$V_{BAT} = 4.5V$ (Forces I_{BAT} and $I_{PROG} = 0$)	●	25	60	μ A
I_{CCMS}	V_{CC} Supply Current in Shutdown	$\overline{V_{EN}} = V_{CC}$	●	10	25	μ A
I_{CCUV}	V_{CC} Supply Current in Undervoltage Lockout	$V_{CC} < V_{BAT}$; $V_{CC} = 3.5V$, $V_{BAT} = 4V$	●	4	10	μ A
V_{FLOAT}	V_{BAT} Regulated Output Voltage	$I_{BAT} = 2mA$ $4.5V < V_{CC} < 8V$, $I_{BAT} = 2mA$	● 4.175	4.2	4.225	V
			● 4.158	4.2	4.242	V
I_{BAT}	BAT Pin Current	$R_{PROG} = 2.43k$, Current Mode, $V_{BAT} = 3.8V$ $R_{PROG} = 12.1k$, Current Mode, $V_{BAT} = 3.8V$	● 475	500	525	mA
			● 94	100	106	mA
I_{BMS}	Battery Drain Current in Shutdown	$\overline{V_{EN}} = V_{CC}$, $V_{CC} > V_{BAT}$	●	0	± 1	μ A
I_{BUV}	Battery Drain Current in Undervoltage Lockout	$V_{CC} < V_{BAT}$, $V_{BAT} = 4V$	●	0	1	μ A
V_{UV}	$V_{CC} - V_{BAT}$ Undervoltage Lockout Threshold	V_{CC} from Low to High, $V_{BAT} = 3.7V$ V_{CC} from High to Low, $V_{BAT} = 3.7V$	● 100	150	200	mV
			● 0	35	80	mV
V_{PROG}	PROG Pin Voltage	$R_{PROG} = 2.43k$, $I_{PROG} = 500\mu A$ $R_{PROG} = 12.1k$, $I_{PROG} = 100\mu A$	● 1.18	1.21	1.24	V
			● 1.18	1.21	1.24	V
V_{MS}	Manual Shutdown Threshold	$\overline{V_{EN}}$ Increasing	● 0.3	0.92	1.2	V
V_{MSHYS}	Manual Shutdown Hysteresis	$\overline{V_{EN}}$ Decreasing		85		mV
$R_{\overline{EN}}$	\overline{EN} Pin Input Resistance	$\overline{V_{EN}} = 5V$	● 1	1.85	3	M Ω
$V_{L_{i}CC}$	Voltage Mode Disable Threshold	$V_{L_{i}CC}$ Increasing (LTC4059 Only)	● 0.3	0.92	1.2	V
$V_{L_{i}CC}HYS$	Voltage Mode Disable Hysteresis	$V_{L_{i}CC}$ Decreasing (LTC4059 Only)		85		mV
V_{ACPR}	ACPR Pin Output Low Voltage	$I_{ACPR} = 300\mu A$ (LTC4059A Only)		0.25	0.5	V
t_{LIM}	Junction Temperature In Constant Temperature Mode			115		$^{\circ}C$
R_{ON}	Power FET "ON" Resistance (Between V_{CC} and BAT)	$I_{BAT} = 150mA$		800	1200	m Ω

Note 1: Absolute Maximum Ratings are those values beyond which the life of a device may be impaired.

Note 2: The LTC4059E/LTC4059AE are guaranteed to meet performance specifications from 0°C to 70°C. Specifications over the -40°C to 85°C

operating temperature range are assured by design, characterization and correlation with statistical process controls.

Note 3: Failure to solder the exposed backside of the package to the PCB board ground plane will result in a thermal resistance much higher than 60°C/W.

TYPICAL PERFORMANCE CHARACTERISTICS

Battery Regulation (Float) Voltage vs Battery Charge Current

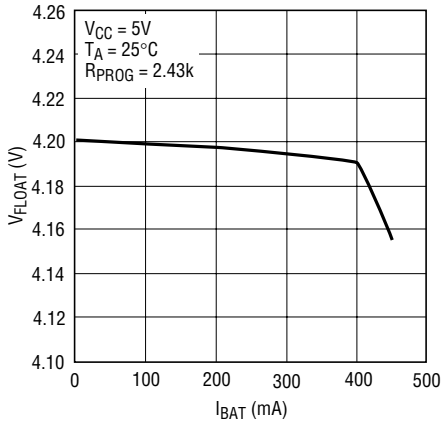

4059 G01

Battery Regulation (Float) Voltage vs Temperature

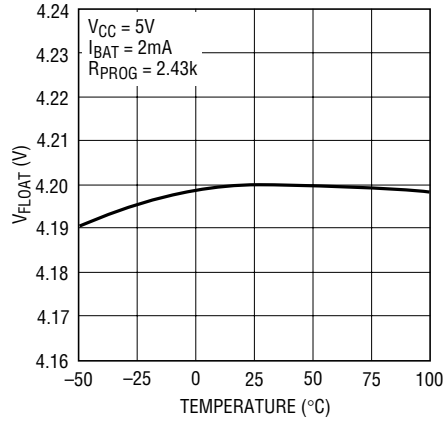

4059 G02

Regulated Output (Float) Voltage vs Supply Voltage

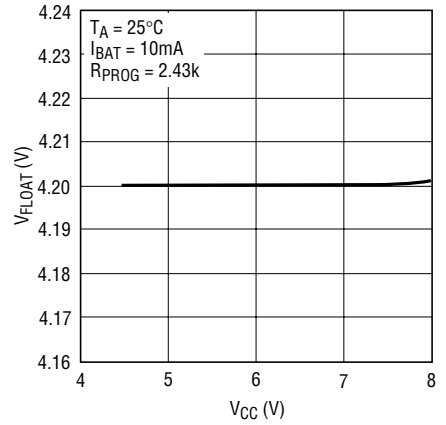

4059 G03

Charge Current vs Input Voltage

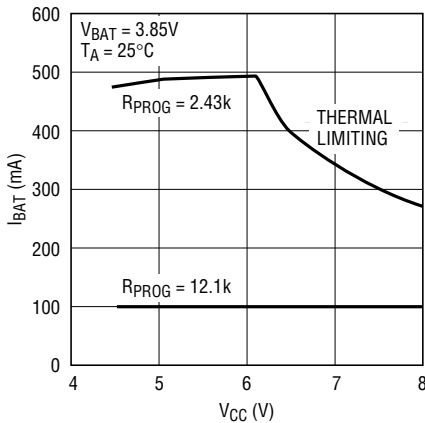

4059 G04

Charge Current vs Battery Voltage

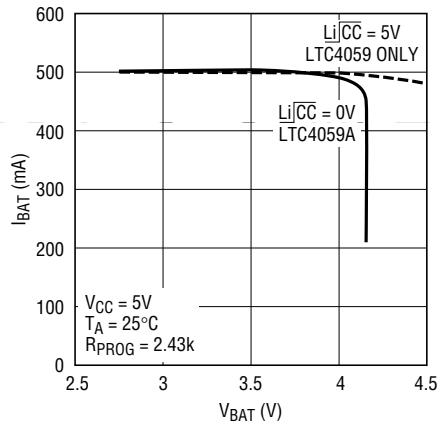

4059 G05

Charge Current vs Ambient Temperature with Thermal Regulation

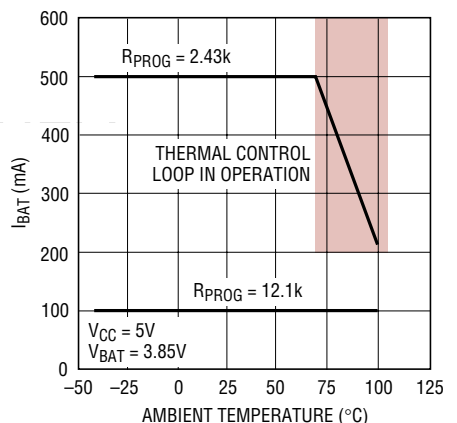

4059 G06

PROG Pin Voltage vs Charge Current

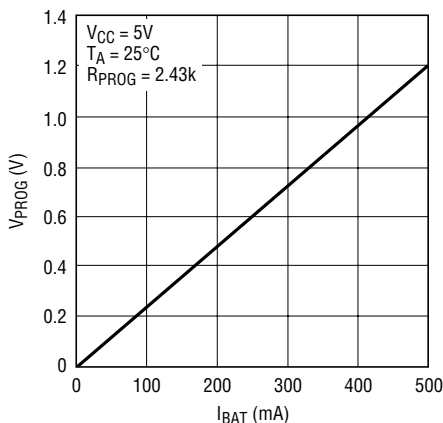

4059 F07

PROG Pin Voltage vs Temperature (Constant Current Mode)

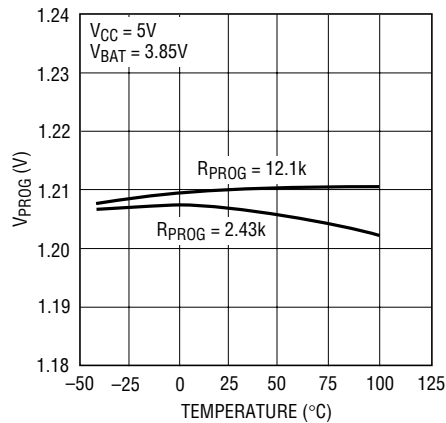

4059 G08

Power FET "ON" Resistance vs Temperature

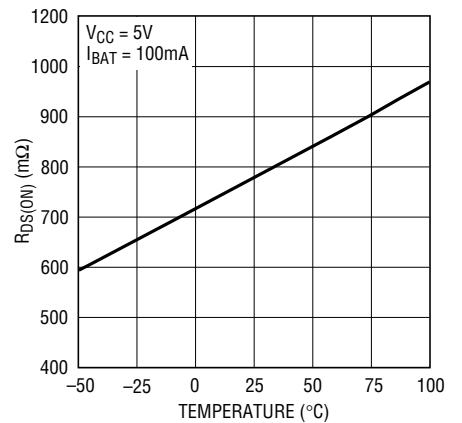

4059 G09
4059fa

TYPICAL PERFORMANCE CHARACTERISTICS

V_{CC} – V_{BAT} Undervoltage Lockout Threshold vs Battery Voltage

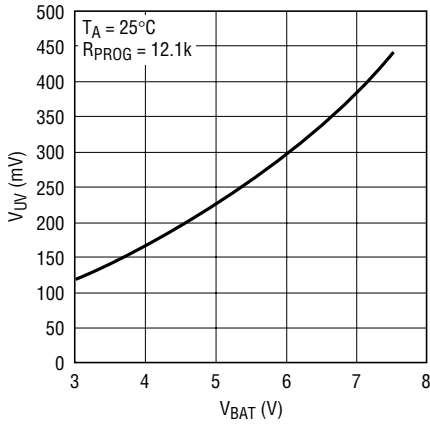

4059 G10

EN Pin Current vs EN Voltage and Temperature

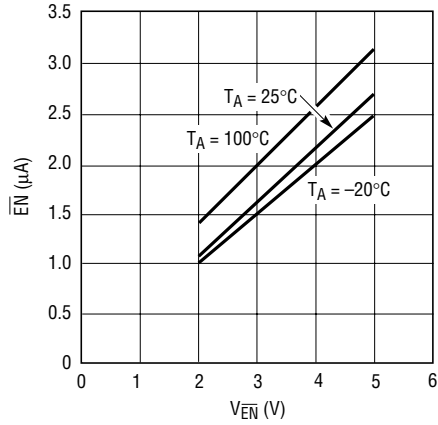

4059 G11

UVLO Battery Drain Current vs Battery Voltage

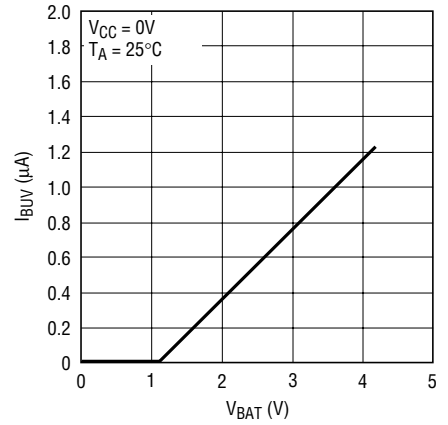

4059 G12

UVLO Battery Drain Current vs Temperature

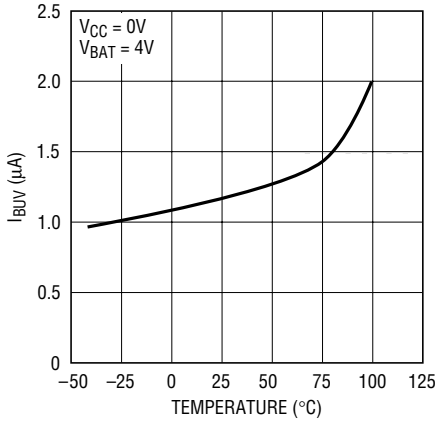

4059 G13

Manual Shutdown Supply Current vs Temperature

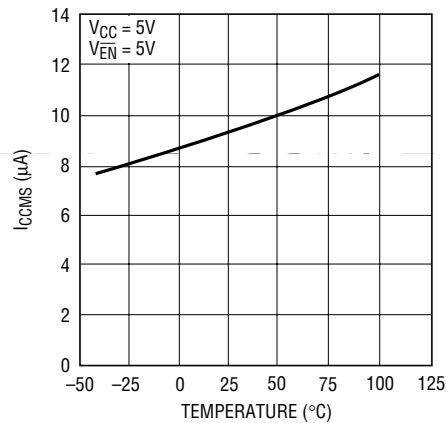

4059 G14

Manual Shutdown Threshold Voltage vs Temperature

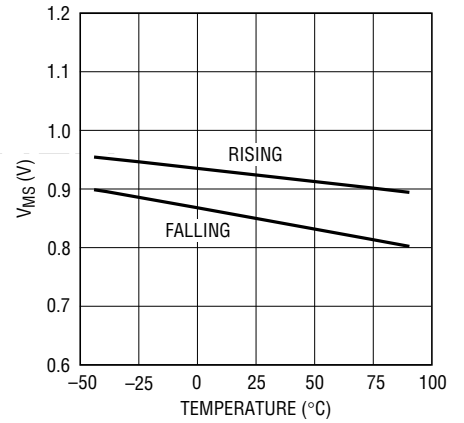

4059 F15

ACPR Pin Output Low Voltage vs Temperature (LTC4059A Only)

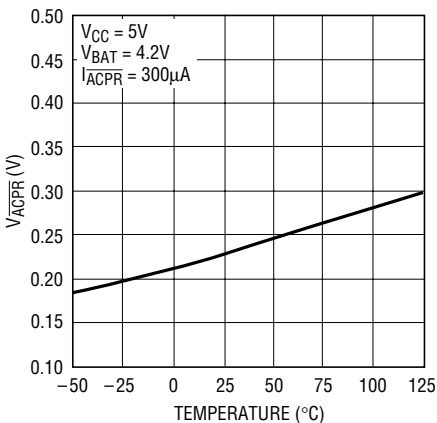

4059 G17

ACPR Pin (Pull-Down State) I-V Curve (LTC4059A Only)

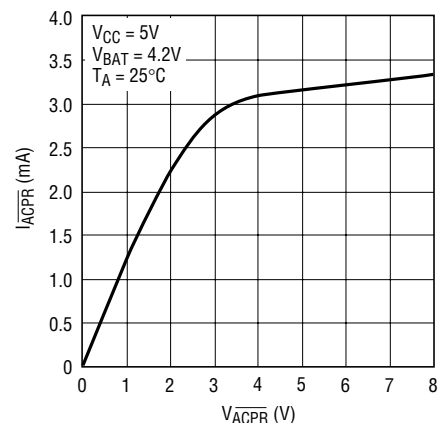

4059 G18

Voltage Mode Disable Threshold Voltage vs Temperature (LTC4059 Only)

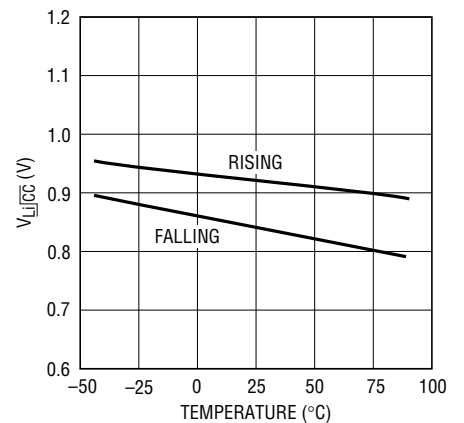

4059 F16
4059fa

PIN FUNCTIONS

GND (Pins 1, 7): Ground/Exposed Pad. The exposed package pad is ground and must be soldered to the PC board for maximum heat transfer.

Li $\overline{\text{CC}}$ (Pin 2, LTC4059): Li-Ion/Constant Current Input Pin. Pulling this pin above $V_{\text{Li}\overline{\text{CC}}}$ disables voltage mode thereby providing a constant current to the BAT pin. This feature is useful for charging Nickel chemistry batteries. Tie to GND if unused.

ACPR (Pin 2, LTC4059A): Open-Drain Power Supply Status Output. When V_{CC} is greater than the undervoltage lockout threshold, the $\overline{\text{ACPR}}$ pin will pull to ground; otherwise the pin is forced to a high impedance state.

BAT (Pin 3): Charge Current Output. Provides charge current to the battery and regulates the final float voltage to 4.2V. An internal precision resistor divider from this pin sets this float voltage and is disconnected in shutdown mode.

V $\overline{\text{CC}}$ (Pin 4): Positive Input Supply Voltage. This pin provides power to the charger. V_{CC} can range from 3.75V to 8V. This pin should be bypassed with at least a 1 μF capacitor. When V_{CC} is within 35mV of the BAT pin voltage, the LTC4059 enters shutdown mode, dropping I_{BAT} to less than 4 μA .

PROG (Pin 5): Charge Current Program and Charge Current Monitor Pin. Connecting a resistor, R_{PROG} , to ground programs the charge current. When charging in constant-current mode, this pin serves to 1.21V. In all modes, the voltage on this pin can be used to measure the charge current using the following formula:

$$I_{\text{BAT}} = \frac{V_{\text{PROG}}}{R_{\text{PROG}}} \cdot 1000$$

EN (Pin 6): Enable Input Pin. Pulling this pin above the manual shutdown threshold (V_{MS} is typically 0.92V) puts the LTC4059 in shutdown mode, thus terminating a charge cycle. In shutdown mode, the LTC4059 has less than 25 μA supply current and less than 1 μA battery drain current. Enable is the default state, but the pin should be tied to GND if unused.

BLOCK DIAGRAM

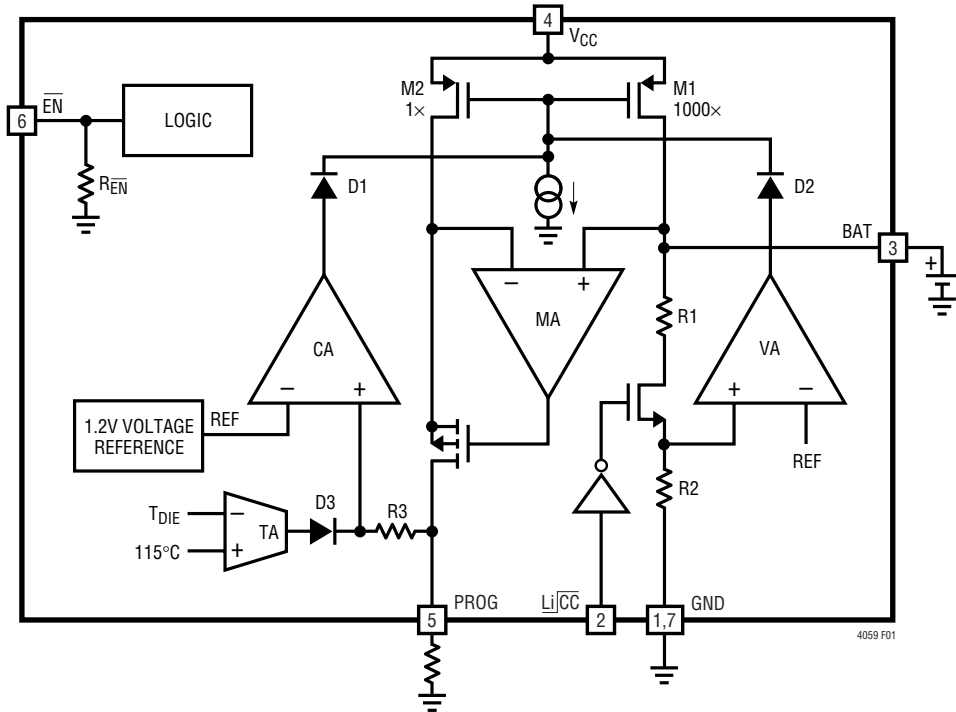

Figure 1 (LTC4059)

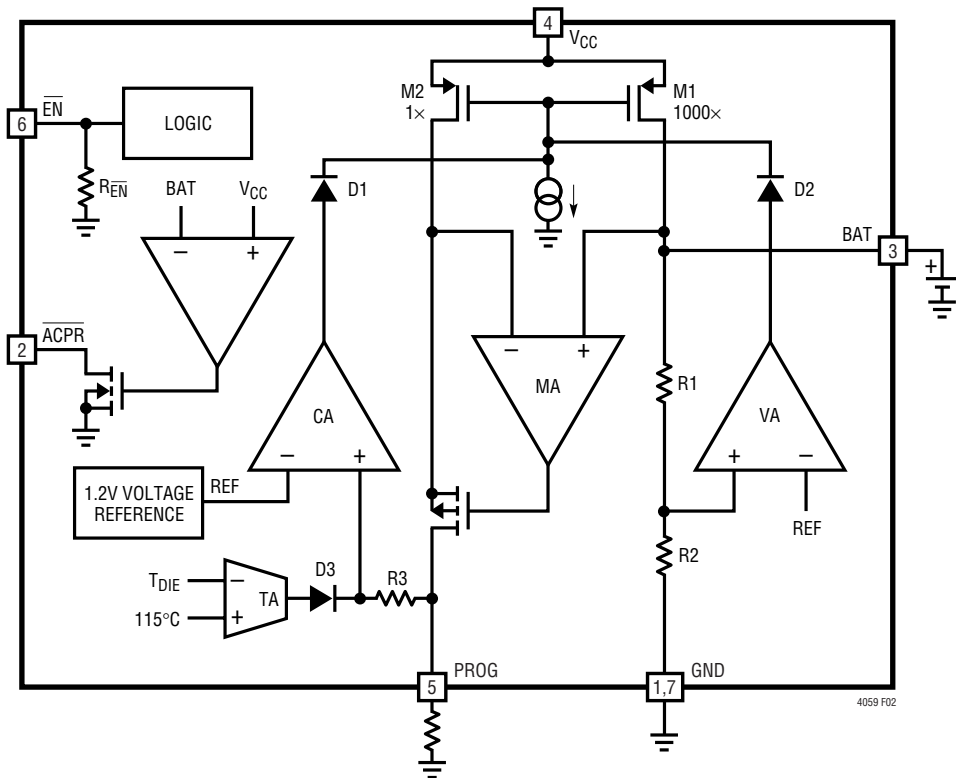

Figure 2 (LTC4059A)

OPERATION

The LTC4059/LTC4059A are linear battery chargers designed primarily for charging single cell lithium-ion batteries. Featuring an internal P-channel power MOSFET, the chargers use a constant-current/constant-voltage charge algorithm with programmable current. Charge current can be programmed up to 900mA with a final float voltage accuracy of $\pm 0.6\%$. No blocking diode or external sense resistor is required; thus, the basic charger circuit requires only two external components. The ACPR pin (LTC4059A) monitors the status of the input voltage with an open-drain output. The $\overline{\text{LiCC}}$ pin (LTC4059) disables constant-voltage operation and turns the LTC4059 into a precision current source capable of charging Nickel chemistry batteries. Furthermore, the LTC4059/LTC4059A are designed to operate from a USB power source.

An internal thermal limit reduces the programmed charge current if the die temperature attempts to rise above a preset value of approximately 115°C . This feature protects the LTC4059/LTC4059A from excessive temperature, and allows the user to push the limits of the power handling capability of a given circuit board without risk of damaging the LTC4059/LTC4059A or external components. Another

benefit of the thermal limit is that charge current can be set according to typical, not worst-case, ambient temperatures for a given application with the assurance that the charger will automatically reduce the current in worst-case conditions.

The charge cycle begins when the voltage at the V_{CC} pin rises approximately 150mV above the BAT pin voltage, a program resistor is connected from the PROG pin to ground, and the $\overline{\text{EN}}$ pin is pulled below the shutdown threshold (typically 0.85V).

If the BAT pin voltage is below 4.2V, or the $\overline{\text{LiCC}}$ pin is pulled above $V_{\overline{\text{LiCC}}}$ (LTC4059 only), the LTC4059 will charge the battery with the programmed current. This is constant-current mode. When the BAT pin approaches the final float voltage (4.2V), the LTC4059 enters constant-voltage mode and the charge current begins to decrease.

To terminate the charge cycle the $\overline{\text{EN}}$ should be pulled above the shutdown threshold. Alternatively, reducing the input voltage below the BAT pin voltage will also terminate the charge cycle.

APPLICATIONS INFORMATION

Programming Charge Current

The charge current is programmed using a single resistor from the PROG pin to ground. The battery charge current is 1000 times the current out of the PROG pin. The program resistor and the charge current are calculated using the following equations:

$$R_{\text{PROG}} = 1000 \cdot \frac{1.21\text{V}}{I_{\text{CHG}}}, \quad I_{\text{CHG}} = 1000 \cdot \frac{1.21\text{V}}{R_{\text{PROG}}}$$

For best stability over temperature and time, 1% metal-film resistors are recommended.

The charge current out of the BAT pin can be determined at any time by monitoring the PROG pin voltage and using the following equation:

$$I_{\text{BAT}} = \frac{V_{\text{PROG}}}{R_{\text{PROG}}} \cdot 1000$$

Undervoltage Lockout (UVLO)

An internal undervoltage lockout circuit monitors the input voltage and keeps the charger in undervoltage lockout until V_{CC} rises approximately 150mV above the BAT pin voltage. The UVLO circuit has a built-in hysteresis of 115mV. If the BAT pin voltage is below approximately 2.75V, then the charger will remain in undervoltage lockout until V_{CC} rises above approximately 3V. During undervoltage lockout conditions, maximum battery drain current is 4 μA .

Power Supply Status Indicator (ACPR, LTC4059A Only)

The power supply status output has two states: pull-down and high impedance. The pull-down state indicates that V_{CC} is above the undervoltage lockout threshold (see Undervoltage Lockout). When this condition is not met, the ACPR pin is high impedance indicating that the LTC4059A is unable to charge the battery.

APPLICATIONS INFORMATION

Shutdown Mode

Charging can be terminated by pulling the $\overline{\text{EN}}$ pin above the shutdown threshold (approximately 0.92V). In shutdown mode, the battery drain current is reduced to less than 1 μA and the supply current to 10 μA .

USB and Wall Adapter Power

Although the LTC4059/LTC4059A allow charging from a USB port, a wall adapter can also be used to charge Li-Ion batteries. Figure 3 shows an example of how to combine wall adapter and USB power inputs. A P-channel MOSFET, MP1, is used to prevent back conducting into the USB port when a wall adapter is present and Schottky diode, D1, is used to prevent USB power loss through the 1k pull-down resistor.

Typically a wall adapter can supply significantly more current than the 500mA limited USB port. Therefore, an N-channel MOSFET, MN1, and an extra program resistor are used to increase the charge current to 850mA when the wall adapter is present.

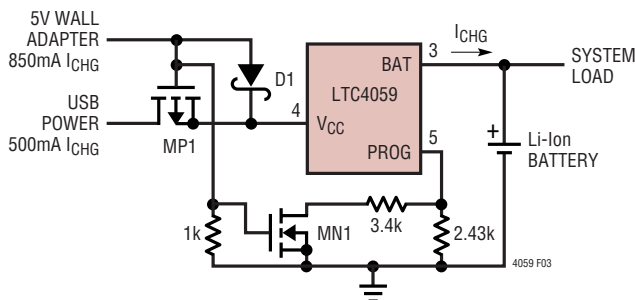

Figure 3. Combining Wall Adapter and USB Power

Constant Current/Constant Voltage/ Constant Temperature

The LTC4059/LTC4059A use a unique architecture to charge a battery in a constant-current, constant-voltage and constant-temperature fashion. Figures 1 and 2 show simplified block diagrams of the LTC4059 and LTC4059A respectively. Three of the amplifier feedback loops shown control the constant-current, CA, constant-voltage, VA, and constant-temperature, TA modes. A fourth amplifier feedback loop, MA, is used to increase the output imped-

ance of the current source pair, M1 and M2 (note that M1 is the internal P-channel power MOSFET). It ensures that the drain current of M1 is exactly 1000 times greater than the drain current of M2.

Amplifiers CA and VA are used in separate feedback loops to force the charger into constant-current or voltage mode, respectively. Diodes D1 and D2 provide priority to either the constant-current or constant-voltage loop; whichever is trying to reduce the charge current the most. The output of the other amplifier saturates low which effectively removes its loop from the system. When in constant-current mode, CA servos the voltage at the PROG pin to be 1.21V. VA servos its inverting input to precisely 1.21V when in constant-voltage mode and the internal resistor divider made up of R1 and R2 ensures that the battery voltage is maintained at 4.2V. The PROG pin voltage gives an indication of the charge current during constant-voltage mode as discussed in the Programming Charge Current section.

Transconductance amplifier, TA, limits the die temperature to approximately 115°C when in constant-temperature mode. TA acts in conjunction with the constant-current loop. When the die temperature exceeds approximately 115°C, TA sources current through R3. This causes CA to reduce the charge current until the PROG pin voltage plus the voltage across R3 equals 1.21V. Diode D3 ensures that TA does not affect the charge current when the die temperature is below approximately 115°C. The PROG pin voltage continues to give an indication of the charge current.

In typical operation, the charge cycle begins in constant-current mode with the current delivered to the battery equal to $1210\text{V}/R_{\text{PROG}}$. If the power dissipation of the LTC4059/LTC4059A results in the junction temperature approaching 115°C, the amplifier (TA) will begin decreasing the charge current to limit the die temperature to approximately 115°C. As the battery voltage rises, the LTC4059/LTC4059A either return to constant-current mode or enter constant-voltage mode straight from constant-temperature mode. Regardless of mode, the voltage at the PROG pin is proportional to the current delivered to the battery.

APPLICATIONS INFORMATION

Power Dissipation

The conditions that cause the LTC4059/LTC4059A to reduce charge current through thermal feedback can be approximated by considering the power dissipated in the IC. For high charge currents, the LTC4059 power dissipation is approximately:

$$P_D = (V_{CC} - V_{BAT}) \cdot I_{BAT}$$

where P_D is the power dissipated, V_{CC} is the input supply voltage, V_{BAT} is the battery voltage and I_{BAT} is the charge current. It is not necessary to perform any worst-case power dissipation scenarios because the LTC4059/LTC4059A will automatically reduce the charge current to maintain the die temperature at approximately 115°C. However, the approximate ambient temperature at which the thermal feedback begins to protect the IC is:

$$T_A = 115^\circ\text{C} - P_D \theta_{JA}$$

$$T_A = 115^\circ\text{C} - (V_{CC} - V_{BAT}) \cdot I_{BAT} \cdot \theta_{JA}$$

Example: Consider an LTC4059 operating from a 5V wall adapter providing 900mA to a 3.7V Li-Ion battery. The ambient temperature above which the LTC4059/LTC4059A begin to reduce the 900mA charge current is approximately:

$$T_A = 115^\circ\text{C} - (5\text{V} - 3.7\text{V}) \cdot (900\text{mA}) \cdot 50^\circ\text{C/W}$$

$$T_A = 115^\circ\text{C} - 1.17\text{W} \cdot 50^\circ\text{C/W} = 115^\circ\text{C} - 59^\circ\text{C}$$

$$T_A = 56^\circ\text{C}$$

The LTC4059 can be used above 56°C, but the charge current will be reduced from 900mA. The approximate current at a given ambient temperature can be calculated:

$$I_{BAT} = \frac{115^\circ\text{C} - T_A}{(V_{CC} - V_{BAT}) \cdot \theta_{JA}}$$

Using the previous example with an ambient temperature of 65°C, the charge current will be reduced to approximately:

$$I_{BAT} = \frac{115^\circ\text{C} - 65^\circ\text{C}}{(5\text{V} - 3.7\text{V}) \cdot 50^\circ\text{C/W}} = \frac{50^\circ\text{C}}{65^\circ\text{C/A}}$$

$$I_{BAT} = 770\text{mA}$$

Furthermore, the voltage at the PROG pin will change proportionally with the charge current as discussed in the Programming Charge Current section.

It is important to remember that LTC4059/LTC4059A applications do not need to be designed for worst-case thermal conditions since the IC will automatically reduce power dissipation when the junction temperature reaches approximately 115°C.

Board Layout Considerations

In order to be able to deliver maximum charge current under all conditions, it is critical that the exposed metal pad on the backside of the LTC4059/LTC4059A package is soldered to the PC board ground. Correctly soldered to a 2500mm² double sided 1oz copper board the LTC4059/LTC4059A have a thermal resistance of approximately 60°C/W. Failure to make thermal contact between the exposed pad on the backside of the package and the copper board will result in thermal resistances far greater than 60°C/W. As an example, a correctly soldered LTC4059/LTC4059A can deliver over 900mA to a battery from a 5V supply at room temperature. Without a backside thermal connection, this number could drop to less than 500mA.

Stability Considerations

The LTC4059 contains two control loops: constant voltage and constant current. The constant-voltage loop is stable without any compensation when a battery is connected with low impedance leads. Excessive lead length, however, may add enough series inductance to require a bypass capacitor of at least 1μF from BAT to GND. Furthermore, a 4.7μF capacitor with a 0.2Ω to 1Ω series resistor from BAT to GND is required to keep ripple voltage low when the battery is disconnected.

High value capacitors with very low ESR (especially ceramic) reduce the constant-voltage loop phase margin. Ceramic capacitors up to 22μF may be used in parallel with a battery, but larger ceramics should be decoupled with 0.2Ω to 1Ω of series resistance.

In constant-current mode, the PROG pin is in the feedback loop, not the battery. Because of the additional pole created by PROG pin capacitance, capacitance on this pin must be kept to a minimum. With no additional capacitance on the PROG pin, the charger is stable with program resistor values as high as 12k. However, additional capacitance on this node reduces the maximum allowed

APPLICATIONS INFORMATION

program resistor. The pole frequency at the PROG pin should be kept above 500kHz. Therefore, if the PROG pin is loaded with a capacitance, C_{PROG} , the following equation should be used to calculate the maximum resistance value for R_{PROG} :

$$R_{PROG} \leq \frac{1}{2\pi \cdot 5 \cdot 10^5 \cdot C_{PROG}}$$

Average, rather than instantaneous, battery current may be of interest to the user. For example, if a switching power supply operating in low current mode is connected in parallel with the battery, the average current being pulled out of the BAT pin is typically of more interest than the instantaneous current pulses. In such a case, a simple RC

filter can be used on the PROG pin to measure the average battery current as shown in Figure 4. A 20k resistor has been added between the PROG pin and the filter capacitor to ensure stability.

V_{CC} Bypass Capacitor

Many types of capacitors can be used for input bypassing; however, caution must be exercised when using multi-layer ceramic capacitors. Because of the self-resonant and high Q characteristics of some types of ceramic capacitors, high voltage transients can be generated under some start-up conditions, such as connecting the charger input to a live power source. For more information, refer to Application Note 88.

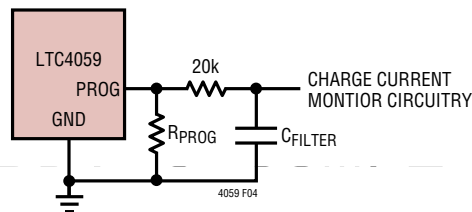

Figure 4. Isolating Capacitive Load on PROG Pin and Filtering

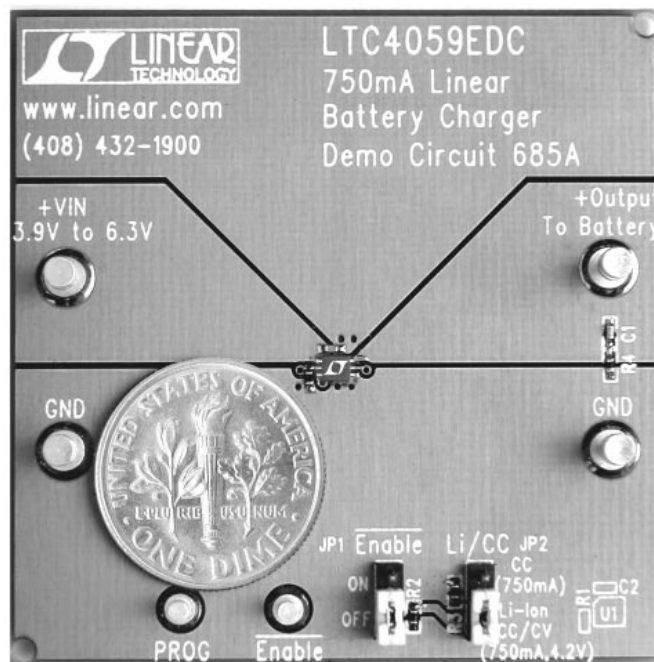
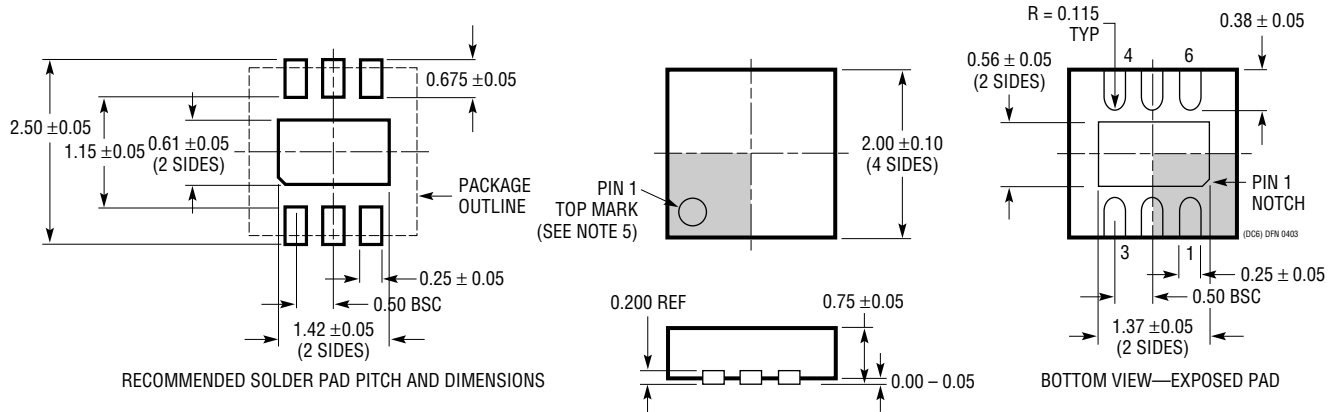

Figure 5. Photo of Typical Circuit (2.5mm × 2.7mm)

PACKAGE DESCRIPTION

DC Package
6-Lead Plastic DFN (2mm × 2mm)
 (Reference LTC DWG # 05-08-1703)



- NOTE:
1. DRAWING TO BE MADE A JEDEC PACKAGE OUTLINE M0-229 VARIATION OF (WCCD-2)
 2. ALL DIMENSIONS ARE IN MILLIMETERS
 3. DIMENSIONS OF EXPOSED PAD ON BOTTOM OF PACKAGE DO NOT INCLUDE MOLD FLASH. MOLD FLASH, IF PRESENT, SHALL NOT EXCEED 0.15mm ON ANY SIDE
 4. EXPOSED PAD SHALL BE SOLDER PLATED
 5. SHADED AREA IS ONLY A REFERENCE FOR PIN 1 LOCATION ON THE TOP AND BOTTOM OF PACKAGE

TYPICAL APPLICATION

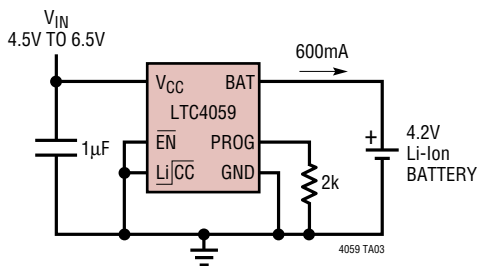

RELATED PARTS

PART NUMBER	DESCRIPTION	COMMENTS
LTC1733	Monolithic Lithium-Ion Linear Battery Charger	Standalone Charger with Programmable Timer, Up to 1.5A Charge Current
LTC1734	Lithium-Ion Linear Battery Charger in ThinSOT™	Simple ThinSOT Charger, No Blocking Diode, No Sense Resistor Needed
LTC1998	Lithium-Ion Low Battery Detector	1% Accurate 2.5µA Quiescent Current, SOT-23
LTC4050	Lithium-Ion Linear Battery Charger Controller	Simple Charger uses External FET, Features Preset Voltages, C/10 Charge Detection and Programmable Timer, Input Power Good Indication, Thermistor Interface
LTC4052	Monolithic Lithium-Ion Battery Pulse Charger	No Blocking Diode or External Power FET Required
LTC4053	USB Compatible Monolithic Li-Ion Battery Charger	Standalone Charger with Programmable Timer, Up to 1.25A Charge Current
LTC4054	Standalone Linear Li-Ion Battery Charger with Integrated Pass Transistor in ThinSOT	Thermal Regulation Prevents Overheating, C/10 Termination, C/10 Indicator
LTC4056	Standalone Lithium-Ion Linear Battery Charger in ThinSOT	Standalone Charger with Programmable Timer, No Blocking Diode, No Sense Resistor Needed
LTC4057	Monolithic Lithium-Ion Linear Battery Charger with Thermal Regulation in ThinSOT	No External MOSFET, Sense Resistor or Blocking Diode Required, Charge Current Monitor for Gas Gauging
LTC4410	USB Power Manager	For Simultaneous Operation of USB Peripheral and Battery Charging from USB Port, Keeps Current Drawn from USB Port Constant, Keeps Battery Fresh, Use with the LTC4053, LTC1733 or LTC4054
LTC4058	950mA Standalone Li-Ion Charger in 3mm × 3mm DFN	USB Compatible, Thermal Regulation Protects Against Overheating

ThinSOT is a trademark of Linear Technology Corporation.