

UMLP28L 3.5x4, Packing Drawing

Packing Description:

UMLP28L 3.5x4 products are classified under Moisture Sensitive Level 1

The carrier tape is made from dissipative polystyrene or polycarbonate resin. The cover tape is a multilayer film primarily composed of polyester film, adhesive layer, heat activated sealant, and anti-static sprayed agent. These reeled parts in standard option are shipped with 5000 units per 330 mm diameter reel. Up to two reels are packed in each intermediate box. The reels is made of polystyrene plastic (anti-static coated or intrinsic).

These full reels are individually barcode labeled and placed inside a pizza box made of recyclable corrugated brown paper with a Fairchild logo printing. The reel is packed single reel in the pizza box. And these pizza boxes are placed inside a barcode labeled shipping box which comes in different sizes depending on the number of parts shipped.

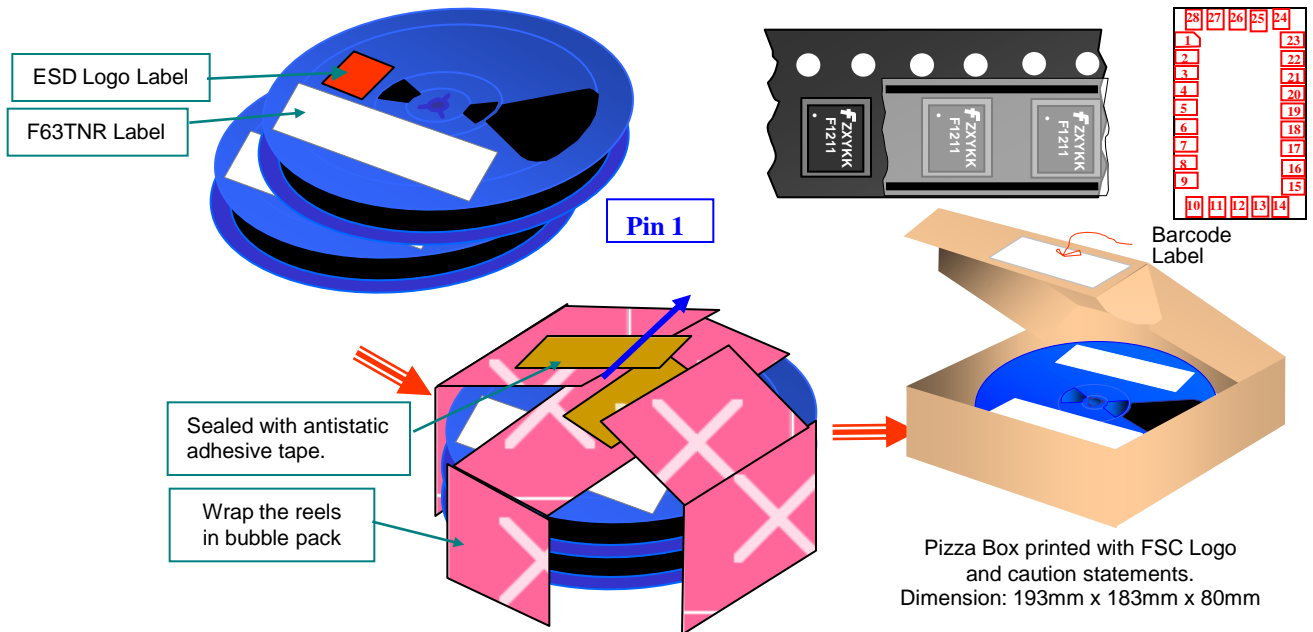

ESD Logo Label sample



Sample of F63TNR Label

| | |
|-------------------------|--|
| LOT: PMH010088888 | QTY: 5000 |
| FSID: FSA1211UMX | SPEC: |
| D/C1: P1215NA QTY1: | SPEC REV: 2 nd Level Interconnect |
| D/C2: QTY2: | 1. Category G4 |
| Green Component | 2. Maximum safe temperature 260 deg C |
| RoHS COMPLIANT | 3. MSL 1 |
| FAIRCHILD SEMICONDUCTOR | (F63TNR)6.0 |

Tape Leader and Trailer Configuration

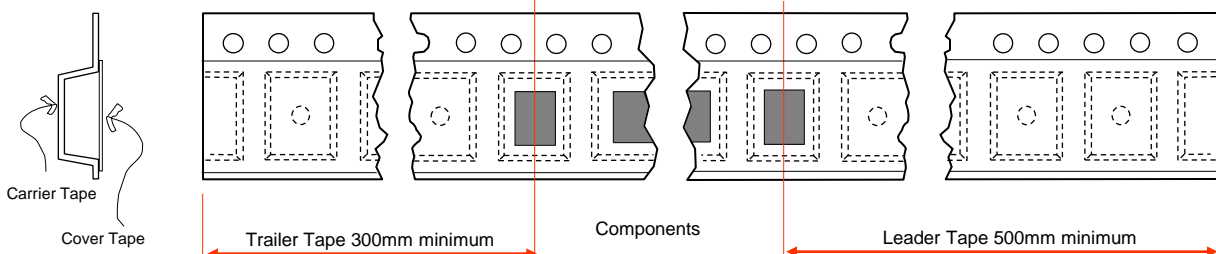

UMLP Embossed Tape Dimension

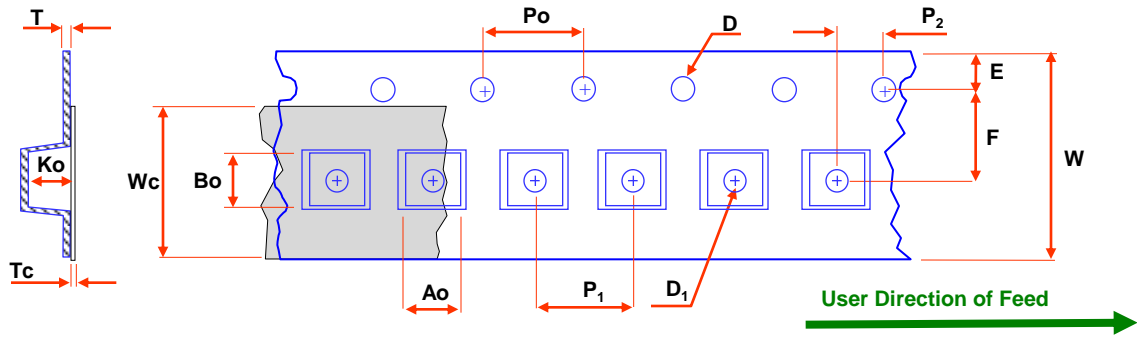

Dimensions are in millimeters

| Package | Ao | Bo | D | D ₁ | E | F | Ko | P ₁ | Po | P ₂ | T | Tc | W | Wc |
|---------|---------|---------|---------|----------------|--------|---------|---------|----------------|-----|----------------|-------|----------|--------|-----|
| | +/-0.05 | +/-0.05 | +/-0.10 | +/-0.05 | +/-0.1 | +/-0.05 | +/-0.05 | TYP | TYP | +/-0/05 | TYP | +/-0.005 | +/-0.3 | TYP |
| UMLP28C | 3.80 | 4.30 | 1.50 | 1.50 | 1.75 | 5.5 | 0.70 | 8 | 4 | 2.0 | 0.300 | 0.06 | 12 | 9.3 |

Notes: Ao, Bo, and Ko dimensions are determined with respect to the EIA /Jedec RS-481 rotational and lateral movement requirements (see sketches A, B, and C).

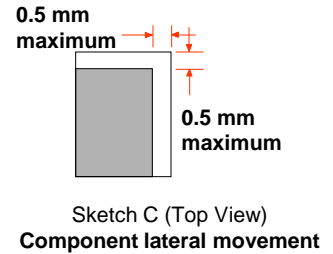
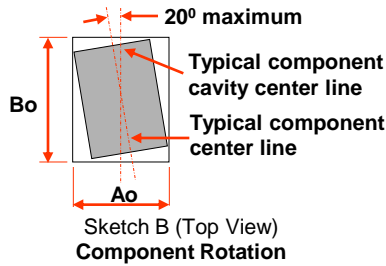
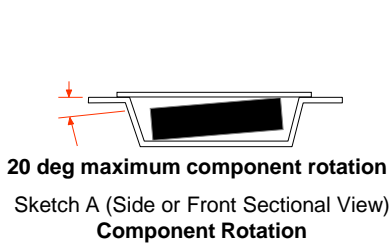

Shipping Reel Dimension

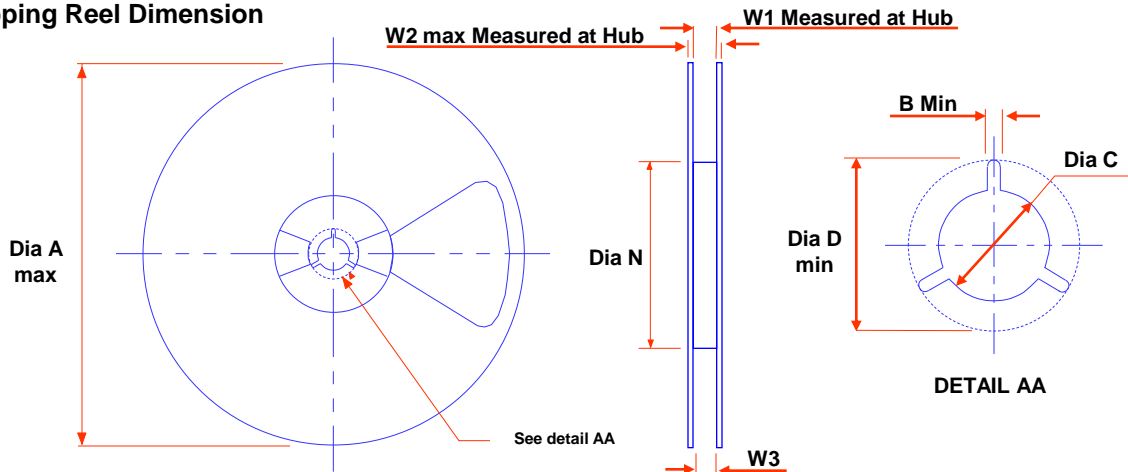

Dimensions are in millimeters

| Tape Width | Dia A max | Dim B min | Dia C +.5/- .2 | Dia D min | Dim N min | Dim W1 +2/-0 | Dim W2 max | Dim W3 (LSL - USL) |
|------------|-----------|-----------|----------------|-----------|-----------|--------------|------------|--------------------|
| 12 | 330 | 1.5 | 13 | 20.2 | 178 | 12.4 | 18.4 | 11.9~15.4 |

| APPROVALS | | DATE | FAIRCHILD SEMICONDUCTOR | | |
|----------------------|--|-------|--|----------------|-----|
| DRAWN | | | UMLP28L 3.5x4 Packing Configuration | | |
| DFTG. CHK. | | | | | |
| ENGR. CHK. | | | | | |
| PROJECTION | | SCALE | SIZE | DRAWING NUMBER | REV |
| INCH (MM) | | 1:1 | N/A | PKG - UMLP28C | 1 |
| DO NOT SCALE DRAWING | | | | SHEET 1 of 1 | |