

UMLP28L 2.9x3.6, Packing Drawing



Packing Description:

UMLP28L 2.9x3.6 products are classified under Moisture Sensitive Level 1

The carrier tape is made from dissipative polystyrene or polycarbonate resin. The cover tape is a multilayer film primarily composed of polyester film, adhesive layer, heat activated sealant, and anti-static sprayed agent. These reeled parts in standard option are shipped with 5000 units per 330 mm diameter reel. Up to two reels are packed in each intermediate box. The reels is made of polystyrene plastic (anti-static coated or intrinsic).

These full reels are individually barcode labeled and placed inside a pizza box made of recyclable corrugated brown paper with a Fairchild logo printing. The reel is packed single reel in the pizza box. And these pizza boxes are placed inside a barcode labeled shipping box which comes in different sizes depending on the number of parts shipped.

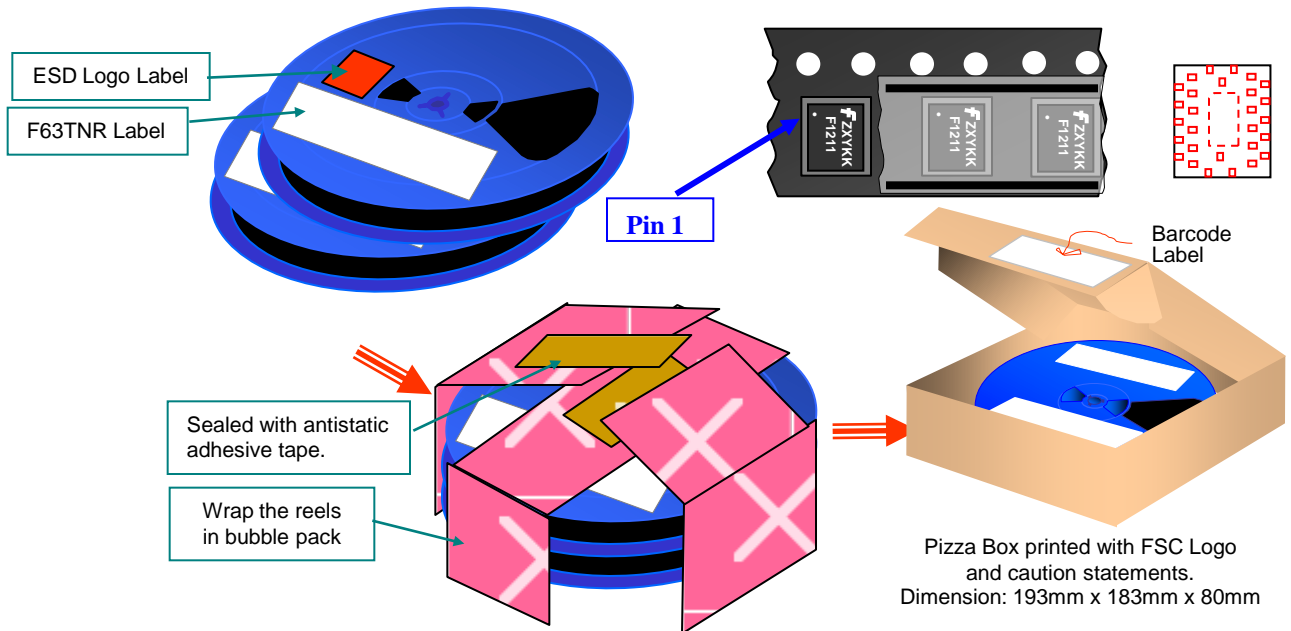

ESD Logo Label sample



Sample of F63TNR Label

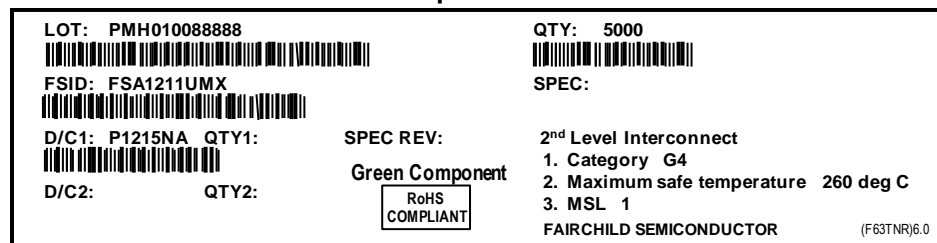

Tape Leader and Trailer Configuration

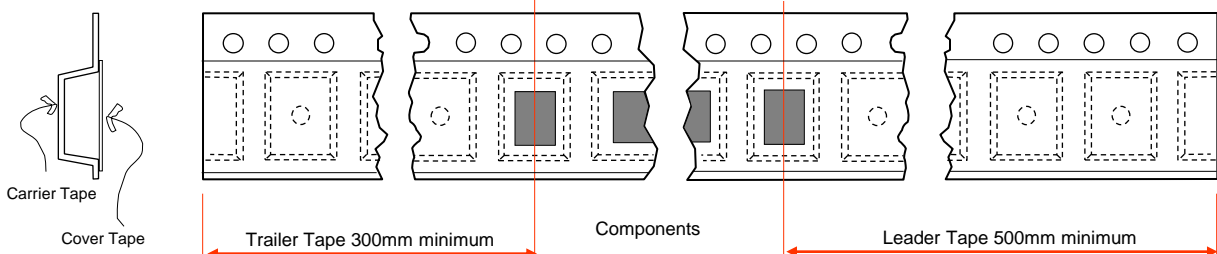

UMLP Embossed Tape Dimension

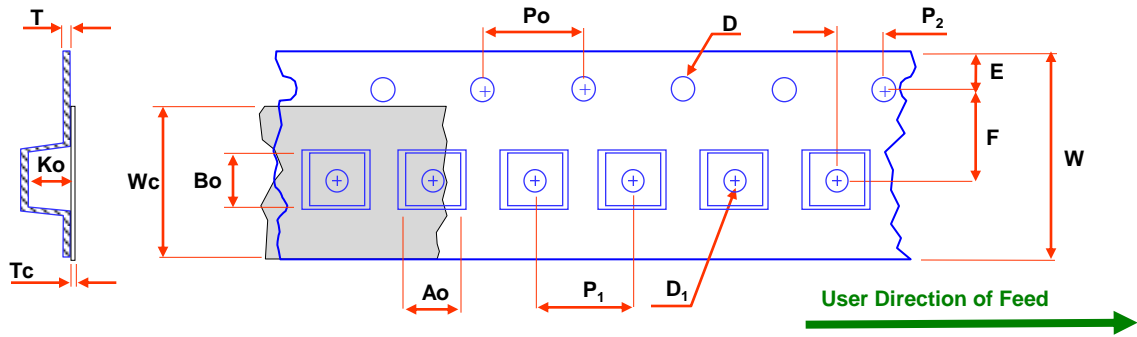

Dimensions are in millimeters

Package	Ao	Bo	D	D ₁	E	F	Ko	P ₁	Po	P ₂	T	Tc	W	Wc
	+/-0.05	+/-0.05	+/-0.10	+/-0.05	+/-0.1	+/-0.05	+/-0.05	TYP	TYP	+/-0/05	TYP	+/-0.005	+/-0.3	TYP
UMLP28A	3.15	3.82	1.50	1.50	1.75	5.5	0.70	8	4	2.0	0.300	0.06	12	9.3

Notes: Ao, Bo, and Ko dimensions are determined with respect to the EIA /Jedec RS-481 rotational and lateral movement requirements (see sketches A, B, and C).

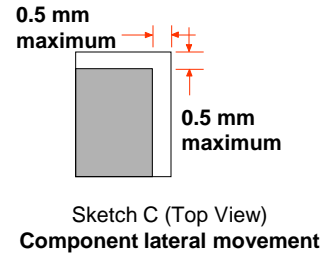
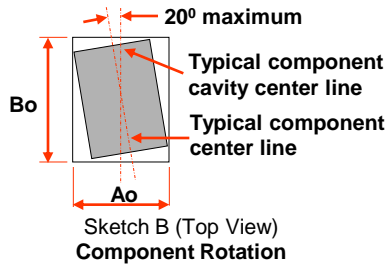
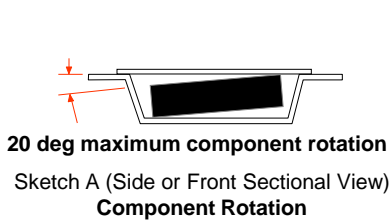

Shipping Reel Dimension

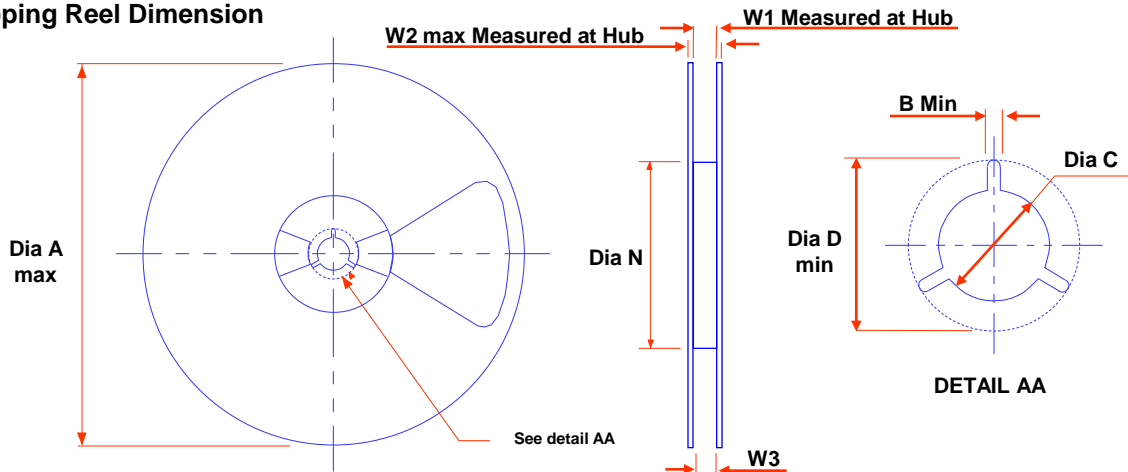

Dimensions are in millimeters

Tape Width	Dia A max	Dim B min	Dia C +.5/- .2	Dia D min	Dim N min	Dim W1 +2/-0	Dim W2 max	Dim W3 (LSL - USL)
12	330	1.5	13	20.2	178	12.4	18.4	11.9~15.4

APPROVALS		DATE			
DRAWN					
DFTG. CHK.					
ENGR. CHK.				UMLP28L 2.9x3.6 Packing Configuration	
PROJECTION		SCALE	SIZE	DRAWING NUMBER	REV
		1:1	N/A	PKG - UMLP28A	1
DO NOT SCALE DRAWING				SHEET 1 of 1	