

## Application Note

### **CoolSET™ & CoolMOS™**

**Ultra Wide Input Range, HV-BIAS Supply for SMPS  
with ICE2B265 and SPA02N80**

Author: Bernd Ilchmann  
Finepower GmbH

Published by Infineon Technologies AG  
<http://www.infineon.com/coolset>

Power Management & Supply



Never stop thinking

## Contents:

1 Short Description.....	3
2 Features .....	3
3 General Description .....	4
4 Description of Function and Components .....	5
5 Results.....	7
5.1 Output Voltage .....	7
5.2 Cross Regulation .....	7
5.3 Protection Features.....	8
5.4 Efficiency .....	9
6 Construction .....	10
7 Bill of Materials .....	11
8 References.....	13

### **WARNING !**

**This bias power supply board works with mortally high voltage! Furthermore, parts of the circuitry are not insulated from the line input. The user has to make sure that no danger or risk can occur for himself or for any other person while voltage is applied to this board.**

**Dependant on the final application this converter must be protected by a fuse or any other element which can disconnect the applied maximum voltage of 800V<sub>DC</sub> in case of failure.**

## 1 Short Description

This application note describes a universal ultra wide input voltage range power supply module. It is typically used as housekeeping power supply in professional SMPS. Typically driven from the bulk capacitor after any PFC stage or from the bulk after a three phase rectifier any DC input voltage from 120V<sub>DC</sub> to 800V<sub>DC</sub> may be applied to this board. It provides a primary (line connected) output voltage as well as a secondary (line isolated) output voltage of 15V<sub>DC</sub> (both). The sum of the output power is up to 12W shared to both outputs.

One typical application is shown in figure 1 below.

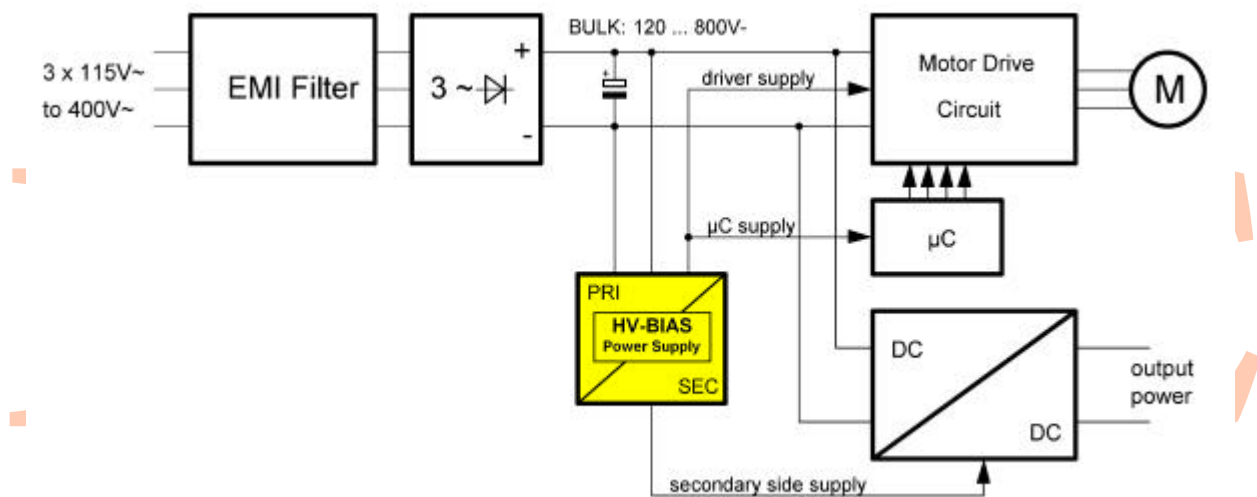

Figure 1: Principle application of the HV-Bias circuit

## 2 Features

The 12W HV-BIAS demonstration board shows a complete two-output DC to DC Flyback circuit. To achieve an ultra wide input voltage range up to 800VDC a transistor with 1200V to 1500V breakdown capability is necessary. This makes the design expensive and reduces the efficiency by its parasitics. On this HV-Bias module Infineon's 600V CoolSET™ is used together with a further 600V or 800V CoolMOS™ transistor.

The user of this module is able to supply any primary or secondary connected circuitry (µC's, PWM's, drivers, relays etc.) independent from the state (short circuit, no load, stand-by or remote-off) of the main SMPS system.

By connecting the input terminals of the CoolBIAS Module across a line filter, rectifier and a sufficient bulk capacitor to the AC line a universal ultra wide input range AC power supply is realizable.

A very high reliability of this module due to the CoolSET's protection features and robustness of the integrated and external CoolMOS™ transistor is achieved.

**Technical specification:**

Input Voltage Range:	120 <sup>1)</sup> V <sub>DC</sub> ... 800V <sub>DC</sub>
Total Output Power:	12W
Output Power Limit:	ca. 15W
Output 1 Voltage, primary:	15V <sub>DC</sub> ± 8% <sup>2)</sup>
Output 2 Voltage, secondary:	15V <sub>DC</sub> ± 12% <sup>2)</sup>
Short Circuit protection:	yes, with auto restart
Efficiency (typ.) @ rated load:	73 ...83 % <sup>3)</sup>
Switching Frequency:	67kHz
PWM & Power Device:	ICE2B265 & SPA02N80 <sup>4)</sup>

<sup>1)</sup> Start-up behavior – see text

<sup>2)</sup> Output 1 & 2 Load Sharing: from 80% / 20% up to 20% / 80%

<sup>3)</sup> Depending on input voltage

<sup>4)</sup> SPA02N80 may be replaced by a (cheaper) 600V CoolMOS if input voltage overshoot is limited to 800V.

### 3 General Description

The input of the HV-Bias module can be connected to any bulk (after rectification) from 115V<sub>AC</sub> single phase up to 400V<sub>AC</sub> multi phase AC front end as well as to the bulk after any PFC stage. Due to the very high maximum input voltage of 800V<sub>DC</sub> and the reflected output voltage of approx. 200V the breakdown capability of the internal switch in the ICE2B265 is exceeded as well as in its high voltage version (ICE2A280).

A series connection of a cheap 600V or 800V CoolMOS™ transistor with the internal CoolSET™ MOSFET forms a self driven cascode witch is able to handle a maximum drain voltage above 1kV. The circuit around the CoolSET™ is very similar to the standard application and not described in this paper therefore.



When C3 is charged up to the start voltage of IC1 the internal MOSFET will switch on and forces the source of the external MOSFET Q1 close to GND. The charge in the junction of the high voltage zener is transferred across R11 to the gate of Q1. D6 limits its maximum gate voltage to 15V. By this way both MOSFET's switch on nearly simultaneously. The transformer's primary winding is applied to the input voltage now.

When the PWM controller of IC1 switches off - the internal MOSFET disconnects the transformer's primary winding from the input. So the voltage across the opened CoolSET™ switch rises (driven by the stored inductive energy) until it is clamped by the source follower Q1. Because the source of Q1 was held down by IC1 before, the gate voltage of Q1 was approx. 15V. So the fast rising drain voltage of IC1 switches off Q1 nearly in the same time (when the voltage is higher than approx. 12V). The increasing voltage charges the junction of D4 across D6, R11 until it is clamping. From now the voltage follower Q1 starts working and stops further increasing of the voltage across IC1. So any additional voltage increases across Q1 until its maximum value.

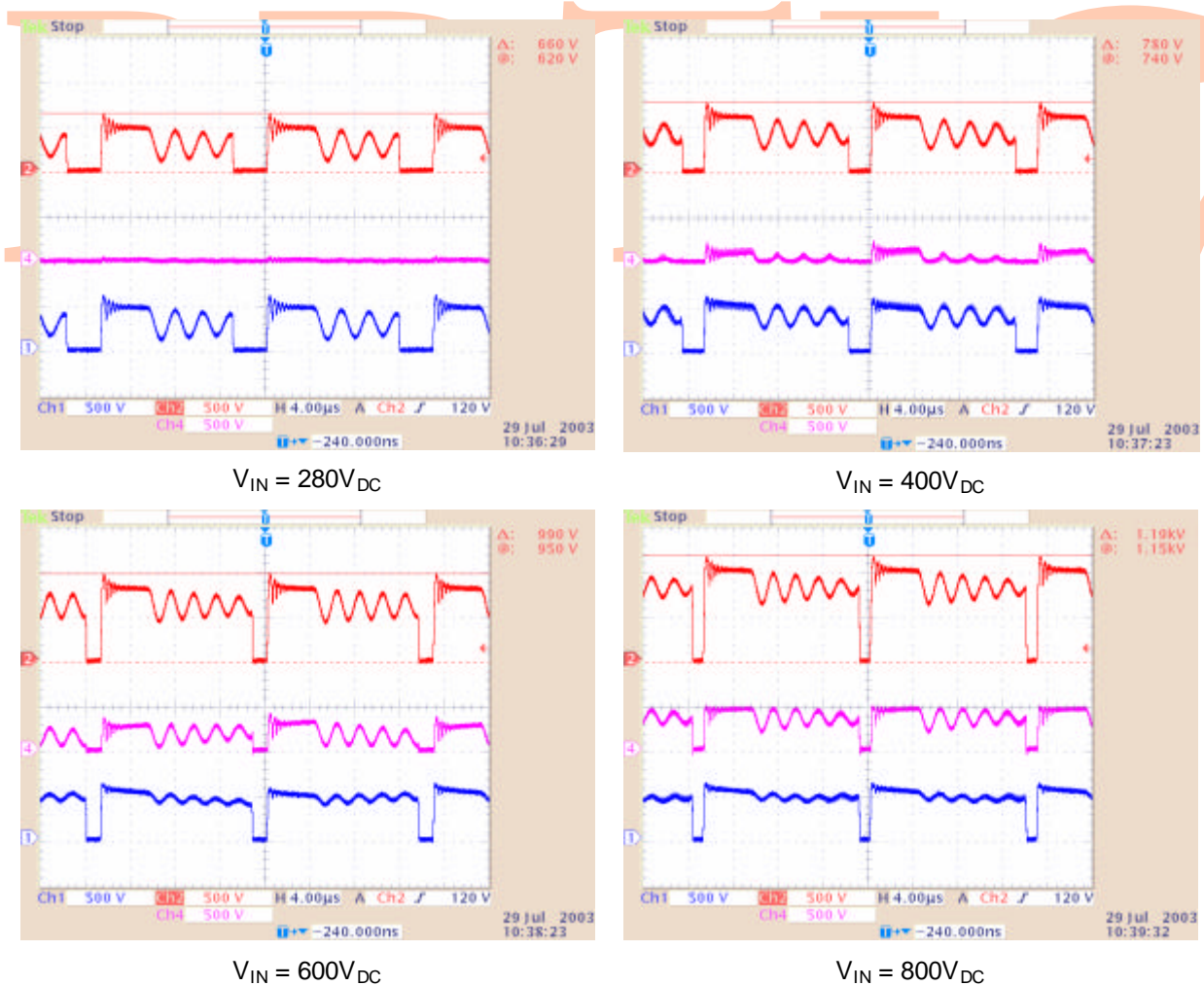

**Figure 3: From top to bottom:  $V_{D-GND}$  (Q1),  $V_{D-S}$  (Q1),  $V_{D-GND}$  (CoolSET™)**

## 5 Results

### 5.1 Output Voltage

The nominal Output voltage on the primary as well as on the secondary side is  $15V_{DC}$ . By a 2% zener diode and a resistive divider this value is realized in a sufficient accuracy. Due to the primary located regulation loop the primary output voltage is quite exact and no dependant from line and load changes on the secondary side. So no clamping zener diode is required to protect the IC from over voltage. If in any application only one (primary) output voltage is required, the user may connect the secondary output parallel to the primary. Figure 4 shows the primary and secondary output voltage versus  $V_{IN}$ .

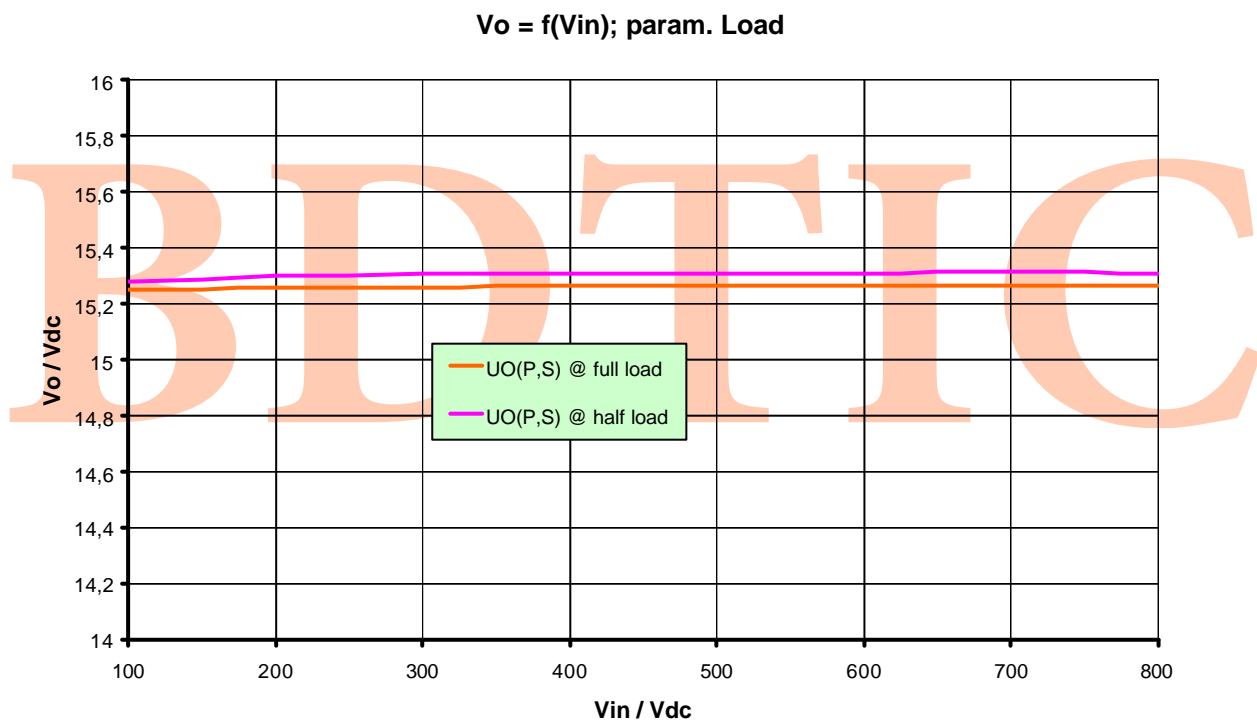

Figure 4: Line Regulation at half and full load

### 5.2 Cross Regulation

The inductive coupled secondary output voltage follows the regulated voltage with a tolerance caused by the leakage inductance between the primary bias and the secondary winding. Additionally, some tolerances in the rectifier diode (forward voltage or temperature) may cause deviation. However, the secondary unregulated output voltage under balanced load sharing tracks the primary voltage very excellent due to the optimized transformer design. Under cross load condition (20%/80% up to 80%/20%) the secondary output voltage stays within the designated tolerances. Figure 5 shows the cross load behavior of the secondary output voltage.

Cross Regulation @ Vin = 400V-

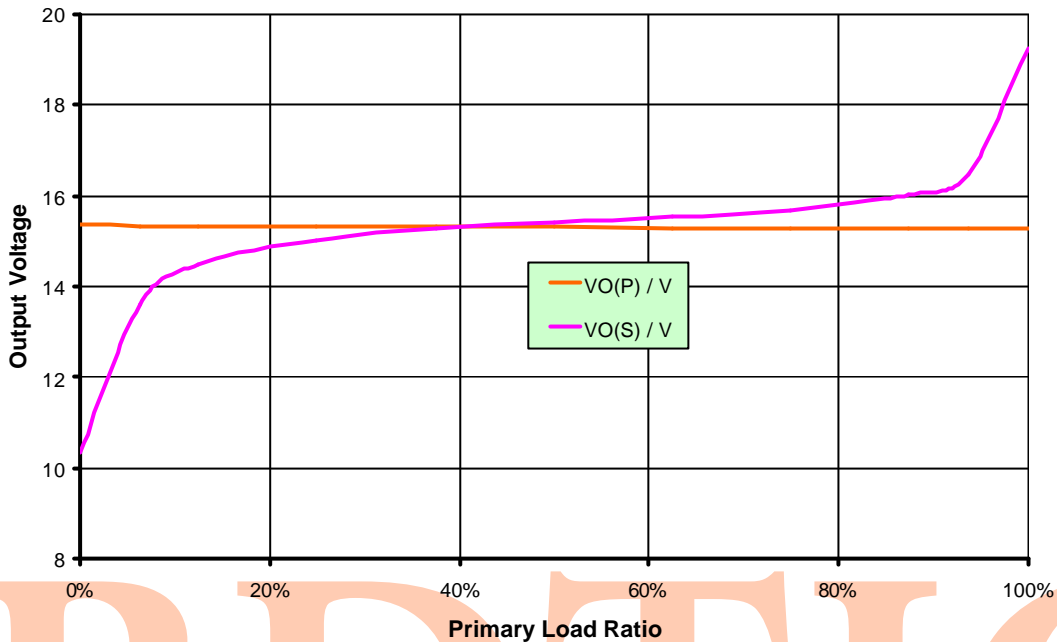

Fig. 5: Cross Regulation while secondary side is shunted with 1k?

### 5.3 Protection Features

Shorted output on the primary side as well as on the secondary side cause the hiccup mode of the controller with no rising of any output voltage. After removing the output short the converter starts automatically.

The output power limit, adjusted by the value of the current sense resistor is set to approx. 15W. By exceeding the output power above this limit the converter goes into the hiccup mode with auto restart as well as under short condition. This avoids excessive stress from any device. By removing R5 from the board the primary regulation loop is cut off. Usually, the output voltage of any flyback converter is rising up to the energy limit, destroying the connected circuitry and the converter. In the described HV-BIAS module a self protection against this failure is introduced in the controller circuit. The PWM controller is detecting the loss of the regulation loop and switches to the hiccup mode.

Figure 6 demonstrates that the overload shutdown which is relatively constant over the ultra wide input voltage range due to the adaptive overload threshold in the CoolSET™-PWM.



### Over Load Shutdown vs. Input Voltage

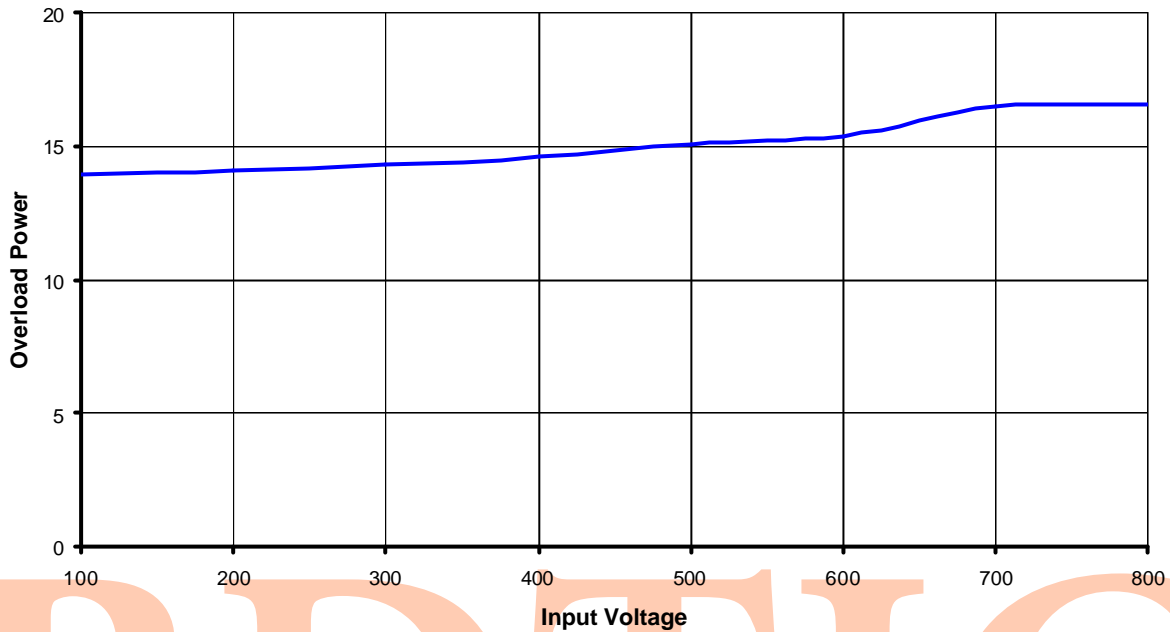

**Fig. 6: Overload Shutdown versus Input Voltage**

In the given design there may be some start-up problems with high external output capacitance at rated power when starting at low line (120V<sub>DC</sub>). Due to the interaction between soft-start capacitance, current sense resistor and start up current a tuning of these components may be necessary if starting is required at very low line. After the converter is started, it works down to approx. 100V<sub>DC</sub> without any problems.

## 5.4 Efficiency

The efficiency of the HV-Bias module is not the main criterion for the design due to its low power consumption. Especially in high voltage or in three phase designs the total transferred power is much more than the rated power level of this bias module. Furthermore, the efficiency depends on the increasing switching losses going square with the input voltage. Nevertheless, the overall efficiency of the converter is sufficient high.

Figure 7 shows the efficiency of the converter versus input voltage at rated output power and half of the rated output power.

Efficiency vs. Input Voltage

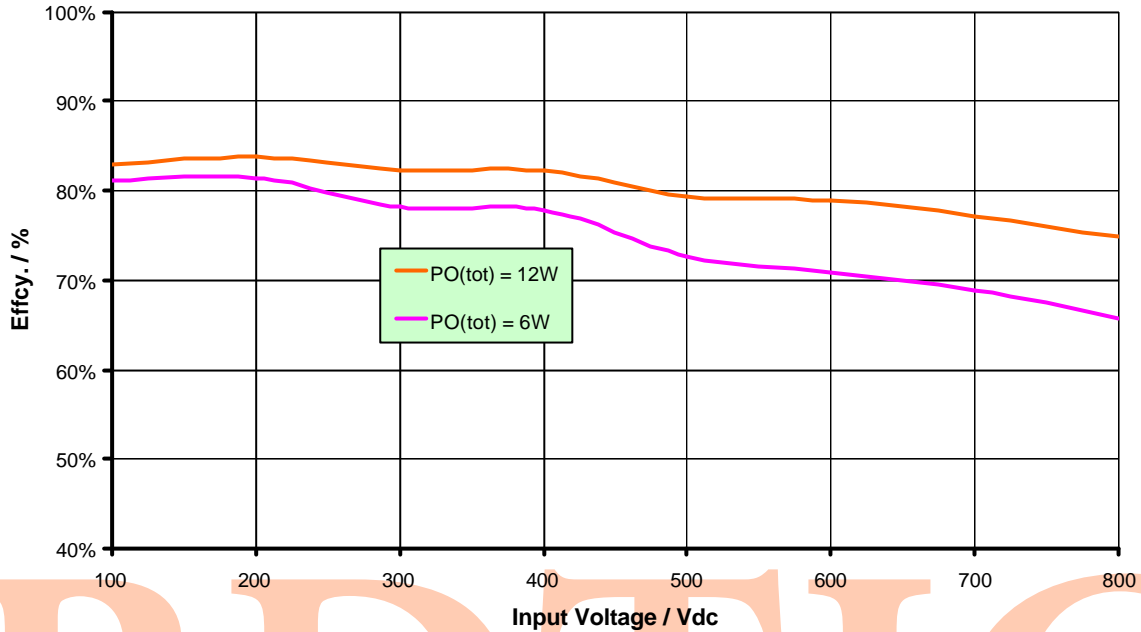

Figure 7: Efficiency of the HV-Bias Module versus Input Voltage

## 6 Construction

The converter is designed on a small double sided PCB. So through hole devices (transformer, IC1, Q1, electrolytic capacitors etc.) can be placed on the opposite side from the SMD's. Figure 8: shows the PCB layout for the top and bottom side layer.

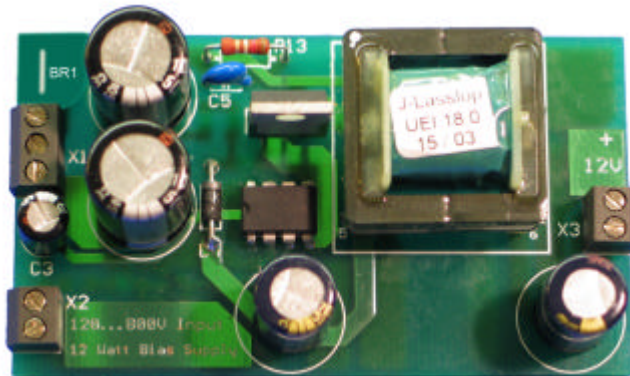

Figure 8: The HV-Bias Module – nearly original size

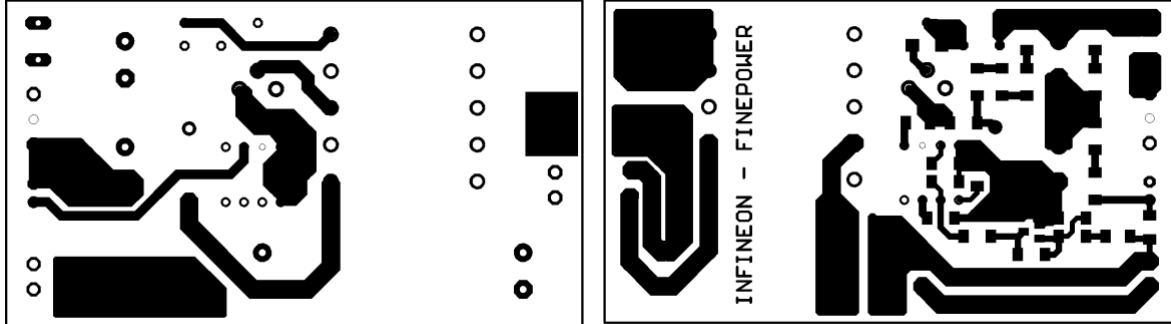

Figure 9: Layout TOP - left and BOTTOM (mirrored) – right

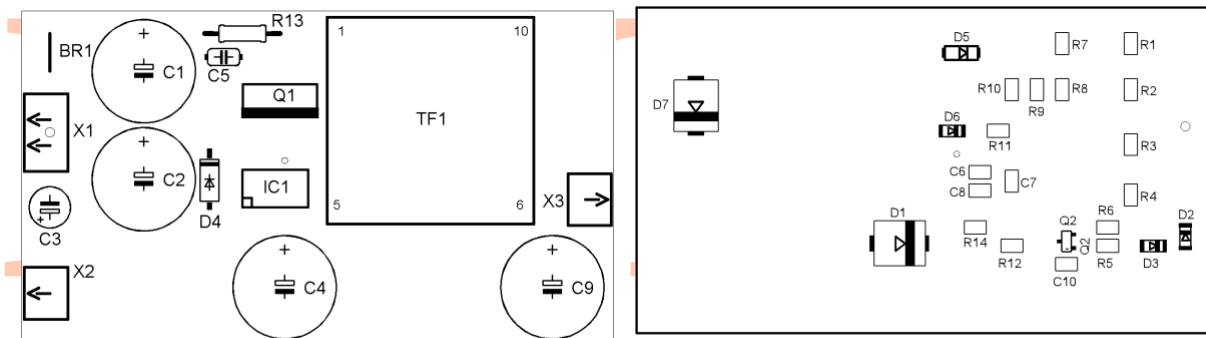

Figure 10: Components placement on the top (left) and the bottom (right) side

## 7 Bill of Materials (part list)

Part	Value 1	Value 2	Ordering Code	Supplier or Manufacturer
BR1		Wire bridge 0.6mm		
C1	10 $\mu$ F / 450V	electrolytic cap, grid: 5mm		various
C2	10 $\mu$ F / 450V	electrolytic cap, grid: 5mm		various
C3	47 $\mu$ F / 50V	electrolytic cap, grid: 2,5mm		various
C4	470 $\mu$ / 25V-	Low ESR electrolytic, grid: 5mm		various
C5	330p / 1kV	NP0, grid. 5.08mm		various

C6	0 $\mu$ 1 / 50V	X7R, SMD1206		various
C7	1 $\mu$ 0 / 25V	X7R, SMD1206		various
C8	2n2 / 50V	NP0, SMD1206		various
C9	1000 $\mu$ / 25V -	Low ESR electrolytic, grid: 5mm		various
D1	ES3D	Ultra Fast Diode, SMC		Vishay - GS
D2	LL4148	Diode SMD		various
D3	ZMM12	Zener diode 12V, SMD		various
D4	P4KE550	HV-Zener, 550V		Vishay - GS
D5	US1M	Ultra Fast Diode , SMA		Vishay - GS
D6	ZMM15	Zener diode 15V, SMD		various
D7	ES3D	Ultra Fast Diode, SMC		Vishay - GS
IC1	ICE2B265	CoolSET™ PWM + Mosfet		Infineon
Q1	SPA02N60-C3	CoolMOS™ 600V / 2A		Infineon
Q2	MMBT2222	NPN transistor, SOT23		ON Semiconductor
R1	330k / 0,2W	SMD1206		various
R2	330k / 0,2W	SMD1206		various
R3	330k / 0,2W	SMD1206		various
R4	330k / 0,2W	SMD1206		various
R5	3k6 / 0,2W	SMD1206		various
R6	4k7 / 0,2W	SMD1206		various
R7	1M0 / 0,2W	SMD1206		various
R8	1M0 / 0,2W	SMD1206		various
R9	1M0 / 0,2W	SMD1206		various
R10	1M0 / 0,2W	SMD1206		various
R11	10R / 0,2W	SMD1206		various
R12	22R / 0,2W	SMD1206		various
R13	120k / 1W	Metal film, grid 10,16		various
R14	1R8 / 0,2W	SMD1206		various
TF1	UEI18.0	Flyback Transformer		Fa. Lasslop

## 8 References

- [1] **Infineon Technologies AG:** "CoolSET™- F2 Offline SMPS Current Mode Controller with integrated 650V/800V CoolMOS™ " Datasheet; Munich; Germany; 08/2002  
[http://www.infineon.com/cgi/ecrm.dll/ecrm/scripts/prod\\_ov.jsp?oid=26910&cat\\_oid=-8179](http://www.infineon.com/cgi/ecrm.dll/ecrm/scripts/prod_ov.jsp?oid=26910&cat_oid=-8179)
- [2] **Infineon Technologies AG:** "SPP02N80C3" 800V CoolMOS™ Transistor; Datasheet; Munich; Germany; 07/2003  
[http://www.infineon.com/cgi/ecrm.dll/ecrm/scripts/prod\\_ov.jsp?oid=25591&cat\\_oid=-8176](http://www.infineon.com/cgi/ecrm.dll/ecrm/scripts/prod_ov.jsp?oid=25591&cat_oid=-8176)
- [3] **Infineon Technologies AG:** (H. Zöllinger, R. Kling) "AN-SMPS-ICE2xXXX-1 – Application Note: CoolSET™ ICE2xXXX for OFF-Line Switch Mode Power Supply (SMPS) Munich; Germany; 02/2002  
[http://www.infineon.com/cgi/ecrm.dll/ecrm/scripts/prod\\_ov.jsp?oid=26910&cat\\_oid=-8179](http://www.infineon.com/cgi/ecrm.dll/ecrm/scripts/prod_ov.jsp?oid=26910&cat_oid=-8179)
- [4] **Infineon Technologies AG:** (B. Ilchmann) "6W Bias Supply for SMPS with ICE2A0565Z"; Application Note: AN-EvalMF2-ICE2A0565Z-1; Munich; Germany; 09/02  
[http://www.infineon.com/cgi/ecrm.dll/ecrm/scripts/prod\\_ov.jsp?oid=26910&cat\\_oid=-8179](http://www.infineon.com/cgi/ecrm.dll/ecrm/scripts/prod_ov.jsp?oid=26910&cat_oid=-8179)

BDTIC

Revision History		
Application Note AN-EvalMF2-ICE2A0565Z-1		
Actual Release: V1.1 Date: 11.03.2008		Previous Release: V1.0
Page of actual Rel.	Page of prev. Rel.	Subjects changed since last release
2 of 14	-----	„WARNING“ (Safety Issue regarding fuse protection)
5 of 14		Schematic (Fig. 2) modified
10 of 14		Photo (Fig. 8) updated
11 of 14		Fig. 10: Placement for top side modified
11 of 14		Bill of Material modified (ex F1, add BR1)

For questions on technology, delivery and prices please contact the Infineon Technologies Offices in Germany or the Infineon Technologies Companies and Representatives worldwide: see the address list on the last page or our webpage at <http://www.infineon.com>

CoolMOS<sup>®</sup> and CoolSET<sup>®</sup> are trademarks of Infineon Technologies AG.

**We listen to Your Comments**

Any information within this document that you feel is wrong, unclear or missing at all?  
Your feedback will help us to continuously improve the quality of this document.  
Please send your proposal (including a reference to this document) to:  
[mcdoku.comment@infineon.com](mailto:mcdoku.comment@infineon.com)

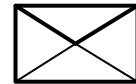

**Edition 2008-03-11**

Published by Infineon Technologies AG,  
Am Campeon 1-12  
D-81726 München

© Infineon Technologies AG 2000.  
All Rights Reserved.

**Attention please!**

The information herein is given to describe certain components and shall not be considered as warranted characteristics.  
Terms of delivery and rights to technical change reserved.  
We hereby disclaim any and all warranties, including but not limited to warranties of non-infringement, regarding circuits, descriptions and charts stated herein.  
Infineon Technologies is an approved CECC manufacturer.

**Information**

For further information on technology, delivery terms and conditions and prices please contact your nearest Infineon Technologies Office in Germany or our Infineon Technologies Representatives worldwide (see address list).

**Warnings**

Due to technical requirements components may contain dangerous substances. For information on the types in question please contact your nearest Infineon Technologies Office.  
Infineon Technologies Components may only be used in life-support devices or systems with the express written approval of Infineon Technologies, if a failure of such components can reasonably be expected to cause the failure of that life-support device or system, or to affect the safety or effectiveness of that device or system. Life support devices or systems are intended to be implanted in the human body, or to support and/or maintain and/or protect human life. If they fail, it is reasonable to assume that the health of the user or other persons may be endangered.