

FEATURES

- Complete Switch Mode Power Supply
- Wide Input Voltage Range: 3V to 36V
- 500mA Output Current
- 0.8V to 5V Output Voltage
- Fixed 1.1MHz Switching Frequency
- Current Mode Control
- (e4) RoHS Compliant Package with Gold Pad Finish
- Programmable Soft-Start
- Tiny, Low Profile (11.25mm × 6.25mm × 2.82mm) Surface Mount LGA Package

APPLICATIONS

- Automotive Battery Regulation
- Power for Portable Products
- Distributed Supply Regulation
- Industrial Supplies
- Wall Transformer Regulation

DESCRIPTION

The LTM[®]8021 is a 36V_{IN} 500mA, step-down DC/DC μ Module[®]. Included in the package are the switching controller, power switches, inductor, and all support components. Operating over an input voltage range of 3V to 36V, the LTM8021 supports an output voltage range of 0.8V to 5V, set by a single resistor. Only an output and bulk input capacitor are needed to finish the design.

The low profile package (2.82mm) enables utilization of unused space on the bottom of PC boards for high density point of load regulation. A built-in soft-start timer is adjustable with just a resistor and capacitor.

The LTM8021 is packaged in a thermally enhanced, compact (11.25mm × 6.25mm) and low profile (2.82mm) overmolded land grid array (LGA) package suitable for automated assembly by standard surface mount equipment. The LTM8021 is RoHS compliant.

LT, LT, LTC, LTM, μ Module, Linear Technology and the Linear logo are registered trademarks of Linear Technology Corporation. All other trademarks are the property of their respective owners.

TYPICAL APPLICATION

7V_{IN} to 36V_{IN}, 5V/500mA μ Module Regulator

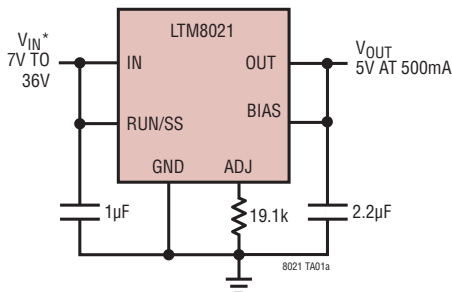

*RUNNING VOLTAGE RANGE. PLEASE REFER TO THE APPLICATIONS INFORMATION SECTION FOR START-UP DETAILS.

Efficiency and Power Loss

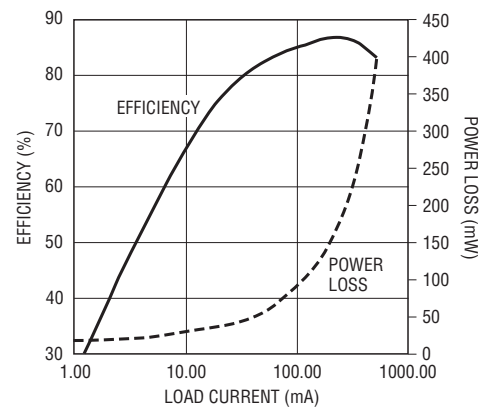

8021 TA01b

LTM8021

ABSOLUTE MAXIMUM RATINGS

(Note 1)

V_{IN} , RUN/SS Voltage.....	40V
RUN/SS Above V_{IN}	3V
ADJ Voltage.....	5V
BIAS Voltage.....	7V
V_{OUT} Voltage.....	10V
Internal Operating Temperature Range (Note 2).....	-40°C to 125°C
Maximum Solder Temperature.....	260°C
Storage Temperature Range.....	-55°C to 125°C

PIN CONFIGURATION

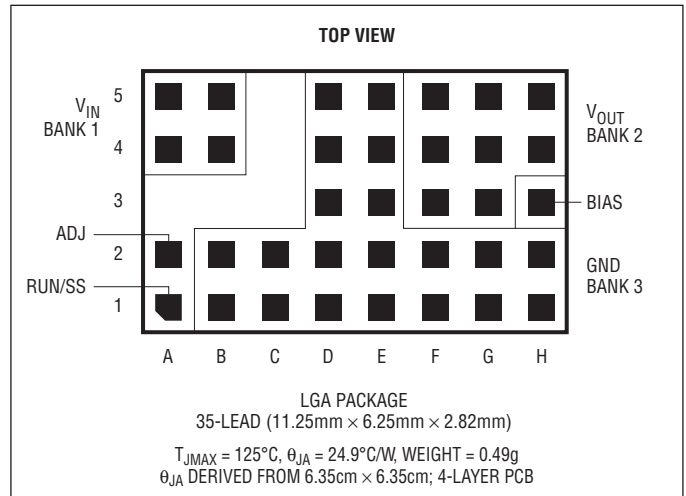

ORDER INFORMATION

LEAD FREE FINISH	PART MARKING*	PACKAGE DESCRIPTION	TEMPERATURE RANGE (NOTE 2)
LTM8021EV#PBF	LTM8021V	35-Lead (11.25mm × 6.25mm × 2.82mm)	-40°C to 125°C
LTM8021IV#PBF	LTM8021V	35-Lead (11.25mm × 6.25mm × 2.82mm)	-40°C to 125°C

Consult LTC Marketing for parts specified with wider operating temperature ranges. *The temperature grade is identified by a label on the shipping container.

For more information on lead free part marking, go to: <http://www.linear.com/leadfree/>

This product is only offered in trays. For more information go to: <http://www.linear.com/packaging/>

ELECTRICAL CHARACTERISTICS

The ● denotes the specifications which apply over the full operating temperature range, otherwise specifications are at $T_A = 25^{\circ}\text{C}$, $V_{IN} = 10\text{V}$, $V_{RUN/SS} = 10\text{V}$, $V_{BIAS} = 3\text{V}$, $R_{ADJ} = 31.6\text{k}$.

SYMBOL	PARAMETER	CONDITIONS	MIN	TYP	MAX	UNITS
V_{IN}	Input DC Voltage	$V_{RUN/SS} = 5\text{V}$, $R_{ADJ} = \text{Open}$	3		36	V
V_{OUT}	Output DC Voltage	$0 < I_{OUT} < 500\text{mA}$; $R_{ADJ} = \text{Open}$ $0 < I_{OUT} < 500\text{mA}$; $R_{ADJ} = 19.1\text{k}$, 0.1%		0.8 5		V V
$R_{ADJ(MIN)}$	Minimum Allowable R_{ADJ}	Note 3	18			k Ω
I_{LK}	Leakage from IN to OUT	$V_{RUN/SS} = V_{BIAS} = 0\text{V}$, $R_{ADJ} = \text{Open}$		2.7	6	μA
I_{OUT}	Continuous Output DC Current	$5\text{V} \leq V_{IN} \leq 36\text{V}$, $V_{BIAS} = V_{OUT}$	0		500	mA
$I_{Q(VIN)}$	Quiescent Current into V_{IN}	$V_{RUN/SS} = 0.2\text{V}$, V_{BIAS} , $R_{ADJ} = \text{Open}$ Not Switching		0.1 1.5	1 2.5	μA mA
$I_{Q(BIAS)}$	Quiescent Current into BIAS	Not Switching		0.15		μA
$\Delta V_{OUT}/V_{OUT}$	Line Regulation	$5\text{V} \leq V_{IN} \leq 36\text{V}$, $I_{OUT} = 500\text{mA}$ $R_{ADJ} = \text{Open}$		0.5		%
$\Delta V_{OUT}/V_{OUT}$	Load Regulation	$V_{IN} = 24\text{V}$, $0 \leq I_{OUT} \leq 500\text{mA}$, $V_{BIAS} = V_{OUT}$		0.35		%

8021fc

ELECTRICAL CHARACTERISTICS

The ● denotes the specifications which apply over the full operating temperature range, otherwise specifications are at $T_A = 25^\circ\text{C}$, $V_{IN} = 10\text{V}$, $V_{RUN/SS} = 10\text{V}$, $V_{BIAS} = 3\text{V}$, $R_{ADJ} = 31.6\text{k}$.

SYMBOL	PARAMETER	CONDITIONS	MIN	TYP	MAX	UNITS
$V_{OUT(DC)}$	DC Output Voltage	$V_{IN} = 24\text{V}$, $0 \leq I_{OUT} \leq 500\text{mA}$ $R_{ADJ} = 31.6\text{k}$, 0.1%		3.3		V
$V_{OUT(AC_RMS)}$	Output Voltage Ripple (RMS)	$V_{IN} = 24\text{V}$, $I_{OUT} = 250\text{mA}$ $C_{OUT} = 2.2\mu\text{F}$, $V_{BIAS} = V_{OUT}$		1		mV
f_{SW}	Switching Frequency	$I_{OUT} = 500\text{mA}$	0.9	1.1	1.3	MHz
I_{OSC}	Short-Circuit Output Current	$V_{IN} = 36\text{V}$, $V_{BIAS} = V_{OUT} = 0\text{V}$		900		mA
I_{ISC}	Short-Circuit Input Current	$V_{IN} = 36\text{V}$, $V_{BIAS} = V_{OUT} = 0\text{V}$		25		mA
ADJ	Voltage at ADJ Pin	R_{ADJ} Open ●	0.79	0.80	0.83	V
$V_{BIAS(MIN)}$	Minimum BIAS Voltage for Proper Operation	$I_{OUT} = 500\text{mA}$		2.2	3	V
I_{ADJ}	Current Out of ADJ Pin	$V_{OUT} = 5\text{V}$, $V_{ADJ} = 0\text{V}$, $RUN/SS = 0\text{V}$		50		μA
$I_{RUN/SS}$	RUN/SS Pin Current	$V_{RUN/SS} = 2.5\text{V}$, R_{ADJ} Open		23		μA
$V_{IH(RUN/SS)}$	RUN/SS Input High Voltage	R_{ADJ} Open, $I_{OUT} = 500\text{mA}$	1.6			V
$V_{IL(RUN/SS)}$	RUN/SS Input Low Voltage	R_{ADJ} Open, $I_{OUT} = 500\text{mA}$			0.5	V
R_{FB}	Internal Feedback Resistor	$RUN/SS = V_{BIAS} = V_{ADJ} = 0\text{V}$		100		$\text{k}\Omega$

Note 1: Stresses beyond those listed under Absolute Maximum Ratings may cause permanent damage to the device. Exposure to any Absolute Maximum Rating condition for extended periods may affect device reliability and lifetime.

Note 2: The LTM8021E is guaranteed to meet performance specifications from 0°C to 125°C internal. Specifications over the full -40°C to 125°C internal operating temperature range are assured by design, characteriza-

tion and correlation with statistical process controls. The LTM8021 is guaranteed to meet specifications over the full -40°C to 125°C internal operating temperature range. Note that the maximum internal temperature is determined by specific operating conditions in conjunction with board layout, the rated package thermal resistance and other environmental factors.

Note 3: Guaranteed by design.

TYPICAL PERFORMANCE CHARACTERISTICS $T_A = 25^\circ\text{C}$, unless otherwise noted

Efficiency vs Load Current

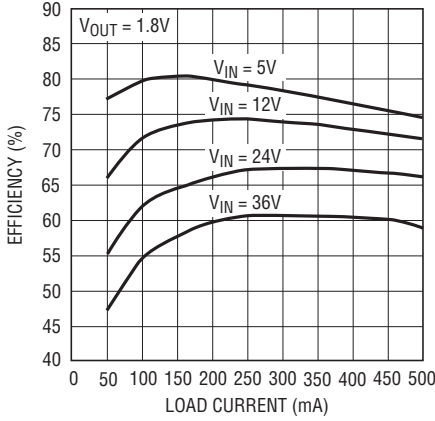

Efficiency vs Load Current

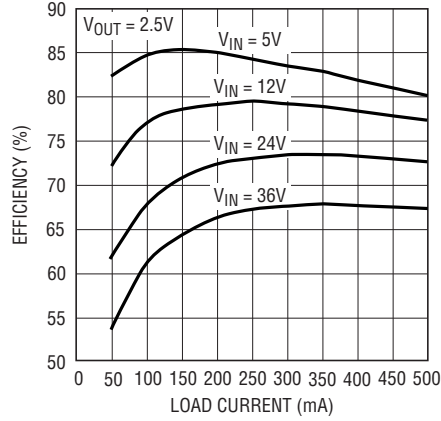

Efficiency vs Load Current

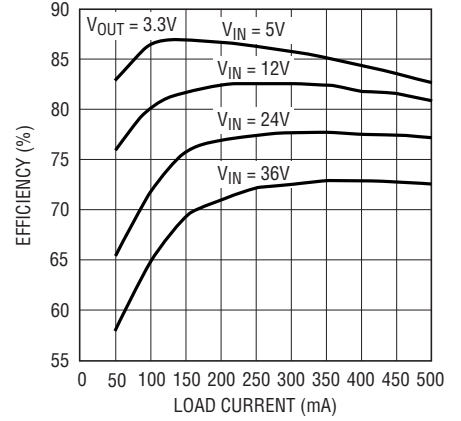

Efficiency vs Load Current

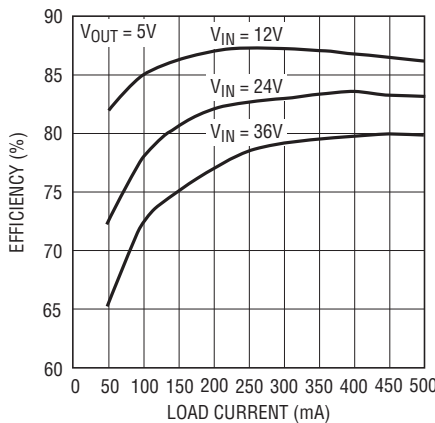

I_{BIAS} vs Load Current

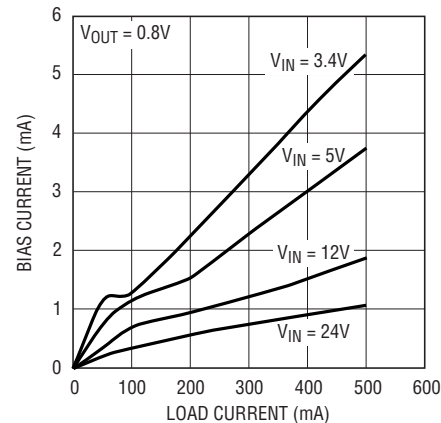

I_{BIAS} vs Load Current

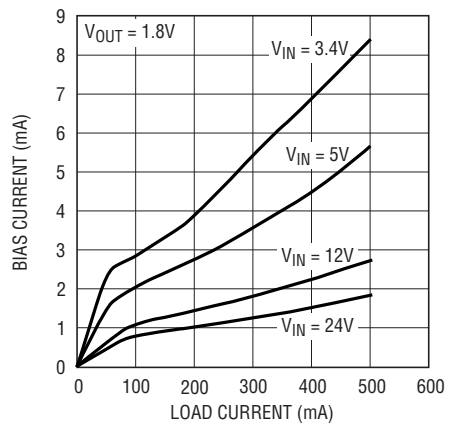

I_{BIAS} vs Load Current

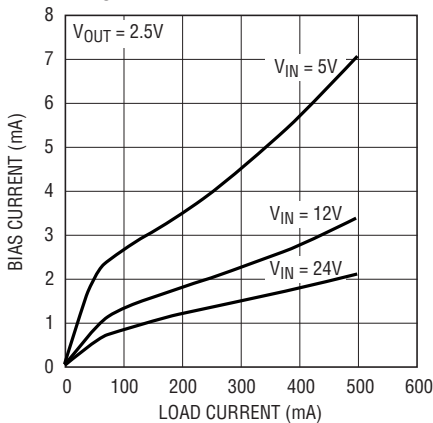

I_{BIAS} vs Load Current

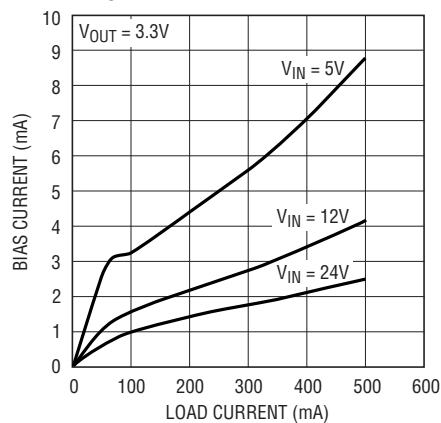

TYPICAL PERFORMANCE CHARACTERISTICS $T_A = 25^\circ\text{C}$, unless otherwise noted

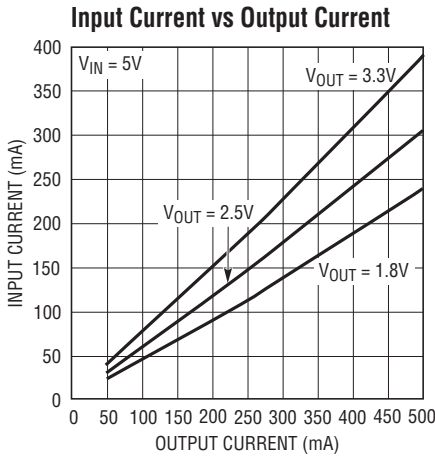

8021 G09

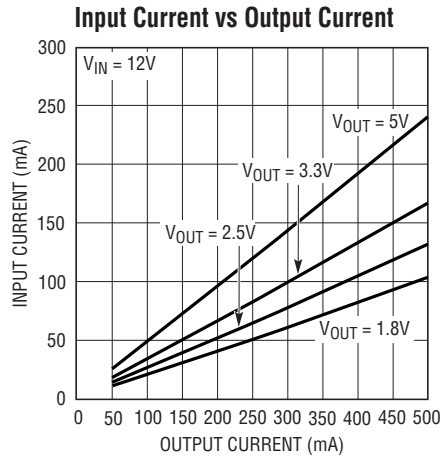

8021 G10

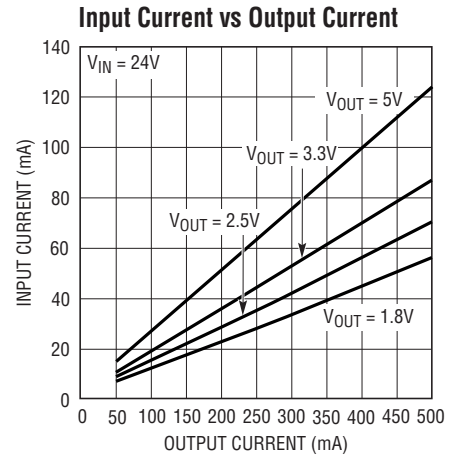

8021 G11

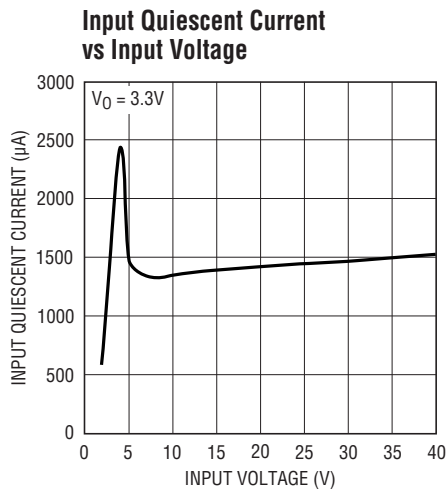

8021 G12

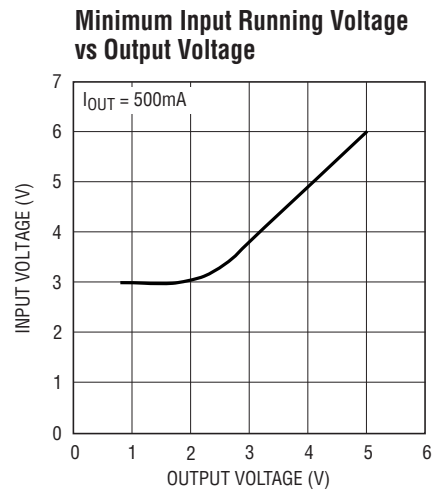

8021 G13

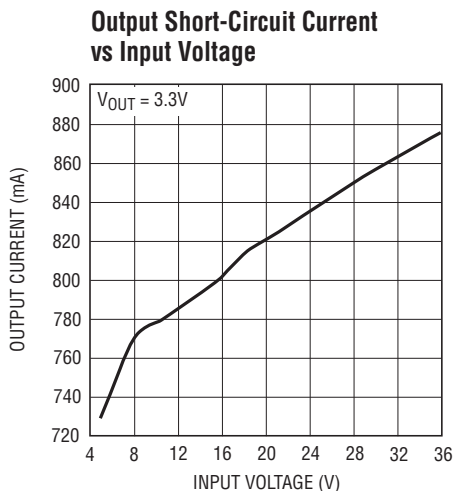

8021 G14

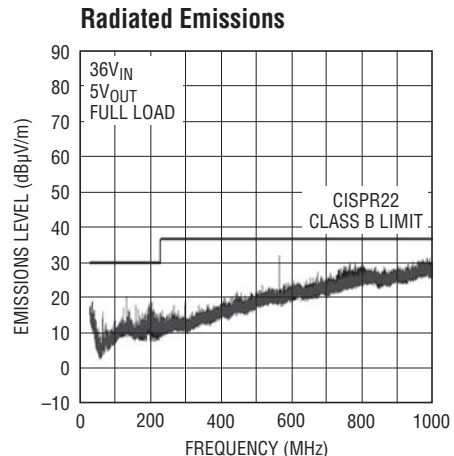

8021 G15

PIN FUNCTIONS

V_{IN} (Bank 1): The V_{IN} pin supplies current to the LTM8021's internal regulator and to the internal power switch. This pin must be locally bypassed with an external, low ESR capacitor of at least $1\mu\text{F}$.

V_{OUT} (Bank 2): Power Output Pins. An external capacitor is connected from V_{OUT} to GND in most applications. Apply output load between these pins and GND pins.

BIAS (Pin H3): The BIAS pin connects to the internal boost Schottky diode and to the internal regulator. Tie to V_{OUT} when $V_{OUT} > 3\text{V}$ or to another DC voltage greater than 3V otherwise. When $\text{BIAS} > 3\text{V}$ the internal circuitry will be powered from this pin to improve efficiency. Main regulator power will still come from V_{IN} .

RUN/SS (Pin A1): Tie RUN/SS pin to ground to shut down the LTM8021. Tie to 1.6V or more for normal operation.

If the shutdown feature is not used, tie this pin to the V_{IN} pin. The RUN/SS also provides soft-start and frequency foldback. To use the soft-start function, connect a resistor and capacitor to this pin. Do not allow the RUN/SS pin to rise above V_{IN} . See the Applications Information section.

GND (Bank 3): The GND connections serve as the main signal return and the primary heat sink for the LTM8021. Tie the GND pins to a local ground plane below the LTM8021 and the circuit components. Return the feedback divider to this signal.

ADJ (Pin A2): The LTM8021 regulates its ADJ pin to 0.8V . Connect the adjust resistor from this pin to ground. The value of R_{ADJ} is given by the equation, $R_{ADJ} = 80 / (V_{OUT} - 0.8)$, where R_{ADJ} is in k.

BLOCK DIAGRAM

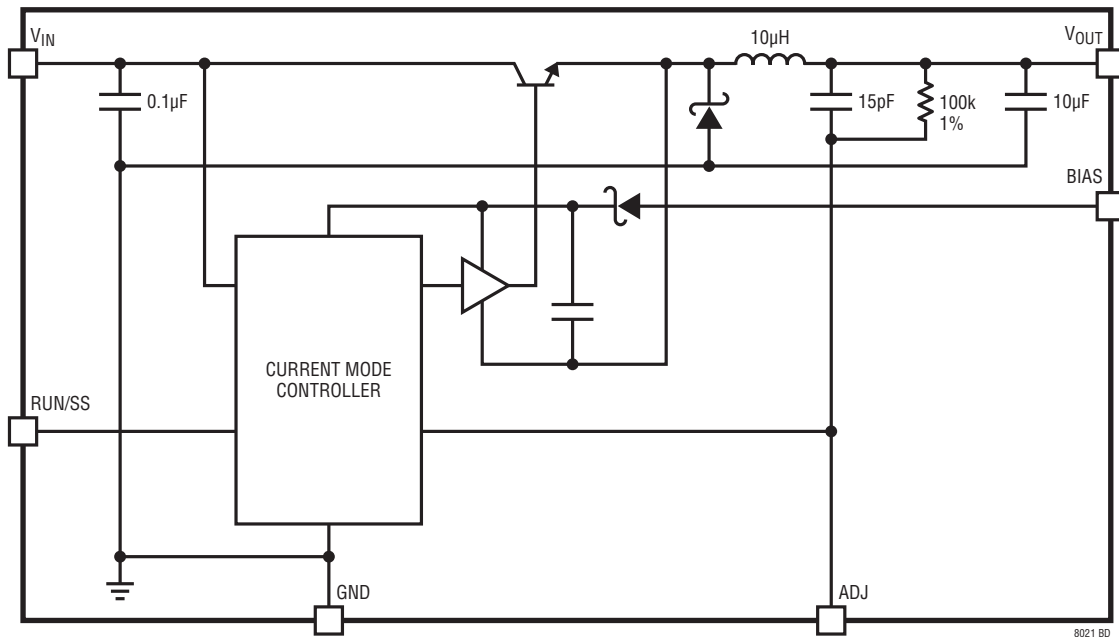

OPERATION

The LTM8021 is a standalone nonisolated step-down switching DC/DC power supply. It can deliver up to 500mA of DC output current with only bulk external input and output capacitors. This module provides a precisely regulated output voltage programmable via one external resistor from $0.8V_{DC}$ to $5V_{DC}$. The input voltage range is 3V to 36V. Given that the LTM8021 is a step-down converter, make sure that the input voltage is high enough to support the desired output voltage and load current. Please refer to the simplified Block Diagram.

The LTM8021 contains a current mode controller, power switching element, power inductor, power Schottky diode and a modest amount of input and output capacitance.

With its high performance current mode controller and internal feedback loop compensation, the LTM8021 module

has sufficient stability margin and good transient performance under a wide range of operating conditions with a wide range of output capacitors, even all ceramic ones (X5R or X7R). Current mode control provides cycle-by-cycle fast current limit, and automatic current limiting protects the module in the event of a short circuit or overload fault.

The LTM8021 is based upon a 1.1MHz fixed frequency PWM current mode controller, equipped with cycle skip capability for low voltage outputs or light loads. A frequency foldback scheme helps to protect internal components from overstress under heavy and short-circuit output loads.

The drive circuit for the internal power switching element is powered through the BIAS pin. Power this pin with at least 3V.

APPLICATIONS INFORMATION

For most applications, the design process is straight forward, summarized as follows:

1. Refer to Table 1 for the row that has the desired input range and output voltage.
2. Apply the recommended C_{IN} , C_{OUT} and R_{ADJ} values.
3. Connect BIAS as indicated.

While these component combinations have been tested for proper operation, it is incumbent upon the user to verify proper operation over the intended system's line, load and environmental conditions.

If the desired output voltage is not listed in Table 1, set the output by applying an R_{ADJ} resistor whose value is given by the equation, $R_{ADJ} = 80/(V_{OUT} - 0.80)$, where R_{ADJ} is in k and V_{OUT} is in volts. Verify the LTM8021's operation over the system's intended line, load and environmental conditions.

Minimum Duty Cycle

The LTM8021 has a fixed 1.1MHz switching frequency. For any given output voltage, the duty cycle falls as the input voltage rises. At very large V_{IN} to V_{OUT} ratios, the duty cycle can be very small. Because the LTM8021's internal controller IC has a minimum on-time, the regulator will skip cycles in order to maintain output voltage regulation. This will result in a larger output voltage ripple and possible disturbances during recovery from a transient load step. The component values provided in Table 1 allow for skip cycle operation, but hold the resultant output ripple to around 50mV, or less. If even less ripple is desired, then more output capacitance may be necessary. Adding a feedforward capacitor has been empirically shown to modestly extend the input voltage range to where the LTM8021 does not skip cycles. Apply the feedforward capacitor between the V_{OUT} pins and ADJ. This injects perturbations into the control loop, therefore, values larger than 50pF are not recommended. A good value to start with is 12pF.

APPLICATIONS INFORMATION

Table 1. Recommended Component Values and Configuration

V _{IN} RANGE	V _{OUT}	C _{IN}	C _{OUT}	R _{ADJ}	BIAS
3.4V to 36V	0.8V	4.7μF	100μF 1210	8.2M	3V to 7V
3.4V to 36V	1.2V	4.7μF	100μF 1210	200k	3V to 7V
3.4V to 36V	1.5V	4.7μF	100μF 1210	115k	3V to 7V
3.4V to 36V	1.8V	2.2μF	100μF 1210	78.7k	3V to 7V
3.5V to 36V	2V	2.2μF	100μF 1210	66.5k	3V to 7V
4V to 36V	2.2V	1μF	22μF 1206	57.6k	3V to 7V
4V to 36V	2.5V	1μF	10μF 0805	47.5k	3V to 7V
5V to 36V	3.3V	1μF	4.7μF 0805	32.4k	V _{OUT}
7V to 36V	5V	1μF	2.2μF 0805	19.1k	V _{OUT}
3.5V to 32V	-3.3V	1μF	4.7μF 0805	32.4k	GND
3.75V to 31V	-5V	1μF	4.7μF 0805	19.1k	GND
3.4V to 15V	0.8V	4.7μF	100μF 1210	8.2M	3V to 7V
3.4V to 15V	1.2V	4.7μF	100μF 1210	200k	3V to 7V
3.4V to 15V	1.5V	4.7μF	47μF 1206	115k	3V to 7V
3.4V to 15V	1.8V	2.2μF	47μF 1206	78.7k	3V to 7V
3.5V to 15V	2V	2.2μF	22μF 1206	66.5k	3V to 7V
4V to 15V	2.2V	1μF	22μF 1206	57.6k	3V to 7V
4V to 15V	2.5V	1μF	10μF 0805	47.5k	3V to 7V
5V to 15V	3.3V	1μF	2.2μF 0805	32.4k	V _{OUT}
7V to 15V	5V	1μF	1μF 0805	19.1k	V _{OUT}
9V to 24V	0.8V	1μF	100μF 1210	Open	3V to 7V
9V to 24V	1.2V	1μF	100μF 1210	200k	3V to 7V
9V to 24V	1.5V	1μF	47μF 1206	115k	3V to 7V
9V to 24V	1.8V	1μF	47μF 1206	78.7k	3V to 7V
9V to 24V	2V	1μF	22μF 1206	66.5k	3V to 7V
9V to 24V	2.2V	1μF	22μF 1206	57.6k	3V to 7V
9V to 24V	2.5V	1μF	10μF 0805	47.5k	3V to 7V
9V to 24V	3.3V	1μF	2.2μF 0805	32.4k	V _{OUT}
9V to 24V	5V	1μF	1μF 0805	19.1k	V _{OUT}
18V to 36V	0.8V	1μF	100μF 1210	Open	3V to 7V
18V to 36V	1.2V	1μF	100μF 1210	200k	3V to 7V
18V to 36V	1.5V	1μF	100μF 1210	115k	3V to 7V
18V to 36V	1.8V	1μF	100μF 1210	78.7k	3V to 7V
18V to 36V	2V	1μF	100μF 1210	66.5k	3V to 7V
18V to 36V	2.2V	1μF	22μF 1206	57.6k	3V to 7V
18V to 36V	2.5V	1μF	10μF 0805	47.5k	3V to 7V
18V to 36V	3.3V	1μF	4.7μF 0805	32.4k	V _{OUT}
18V to 36V	5V	1μF	2.2μF 0805	19.1k	V _{OUT}

APPLICATIONS INFORMATION

Capacitor Selection Considerations

The C_{IN} and C_{OUT} capacitor values in Table 1 are the minimum recommended values for the associated operating conditions. Applying capacitor values below those indicated in Table 1 is not recommended, and may result in undesirable operation. Using larger values is generally acceptable, and can yield improved dynamic response or fault recovery, if it is necessary. Again, it is incumbent upon the user to verify proper operation over the intended system's line, load and environmental conditions.

Ceramic capacitors are small, robust and have very low ESR. However, not all ceramic capacitors are suitable. X5R and X7R types are stable over temperature and applied voltage and give dependable service. Other types, including Y5V and Z5U have very large temperature and voltage coefficients of capacitance. In an application circuit they may have only a small fraction of their nominal capacitance resulting in much higher output voltage ripple than expected.

Ceramic capacitors are also piezoelectric. At light loads, the LTM8021 skips switching cycles in order to maintain regulation. The resulting bursts of current can excite a ceramic capacitor at audio frequencies, generating audible noise.

If this audible noise is unacceptable, use a high performance electrolytic capacitor at the output. This output capacitor can be a parallel combination of a 1 μ F ceramic capacitor and a low cost electrolytic capacitor.

A final precaution regarding ceramic capacitors concerns the maximum input voltage rating of the LTM8021. A ceramic input capacitor combined with trace or cable inductance forms a high Q (under damped) tank circuit. If the LTM8021 circuit is plugged into a live supply, the input voltage can ring to twice its nominal value, possibly exceeding the device's rating. This situation is easily avoided; see the Hot-Plugging Safely section.

Minimum Input Voltage

The LTM8021 is a step-down converter, so a minimum amount of headroom is required to keep the output in regulation. For most applications at full load, the input must be about 1.5V above the desired output. In addition, it takes more input voltage to turn on than is required for continuous operation. This is shown in Figure 1.

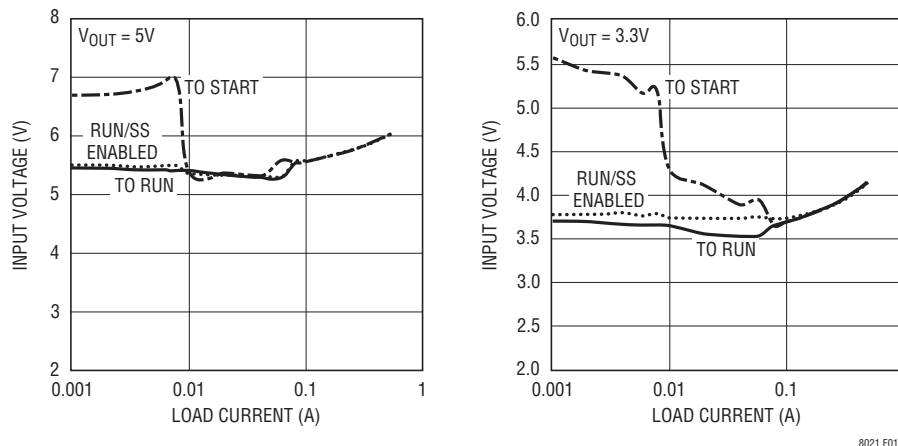

Figure 1. The LTM8021 Requires More Voltage to Start Than to Run

8021 F01

APPLICATIONS INFORMATION

Soft-Start

The RUN/SS pin can be used to soft-start the LTM8021, reducing the maximum input current during start-up. The RUN/SS pin is driven through an external RC filter to create a voltage ramp at this pin. Figure 2 shows the soft-start circuit. By choosing a large RC time constant, the peak start-up current can be reduced to the current that is required to regulate the output, with no overshoot. Choose the value of the resistor so that it can supply $80\mu\text{A}$ when the RUN/SS pin reaches 2V.

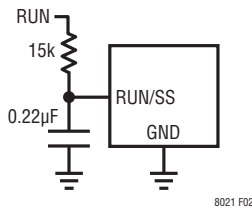

Figure 2. To Soft-Start the LTM8021, Add a Resistor and Capacitor to the RUN/SS Pin

Shorted Input Protection

Care needs to be taken in systems where the output will be held high when the input to the LTM8021 is absent. This may occur in battery charging applications or in battery backup systems where a battery or some other supply is diode ORed with the LTM8021's output. If the V_{IN} pin is allowed to float and the RUN/SS pin is held high (either by a logic signal or because it is tied to V_{IN}), then the LTM8021's internal circuitry will pull its quiescent current through its internal power switch. This is fine if your system can tolerate a few milliamps in this state. If the RUN/SS pin is grounded, the internal power switch current will drop to essentially zero. However, if the V_{IN} pin is grounded while the output is held high, then parasitic diodes inside the LTM8021 can pull large currents from the output through the internal power switch and the V_{IN} pin. Figure 3 shows a circuit that will run only when the input voltage is present and that protects against a shorted or reversed input.

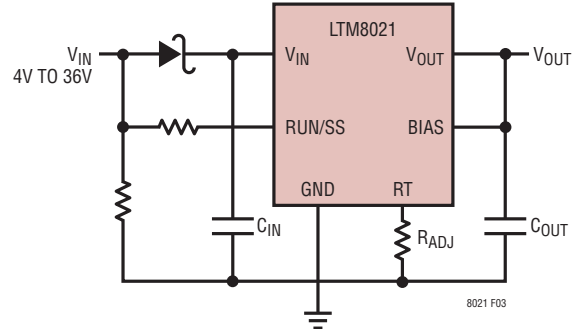

Figure 3. The Input Diode Prevents a Shorted Input from Discharging a Backup Battery Tied to the Output. It Also Protects the Circuit from a Reversed Input. The LTM8021 Runs Only When the Input is Present

APPLICATIONS INFORMATION

PCB Layout

Most of the problems associated with the PCB layout have been alleviated or eliminated by the high level of integration of the LTM8021. The LTM8021 is nevertheless a switching power supply, and care must be taken to minimize EMI and ensure proper operation. Even with the high level of integration, one may fail to achieve a specified operation with a haphazard or poor layout. See Figure 4 for a suggested layout.

Ensure that the grounding and heatsinking are acceptable. A few rules to keep in mind are:

1. Place the C_{IN} capacitor as close as possible to the V_{IN} and GND connection of the LTM8021.
2. Place the C_{OUT} capacitor as close as possible to the V_{OUT} and GND connection of the LTM8021.
3. Place the C_{IN} and C_{OUT} capacitors such that their ground currents flow directly adjacent to, or underneath the LTM8021.
4. Connect all of the GND connections to as large a copper pour or plane area as possible on the top layer. Avoid breaking the ground connection between the external components and the LTM8021.

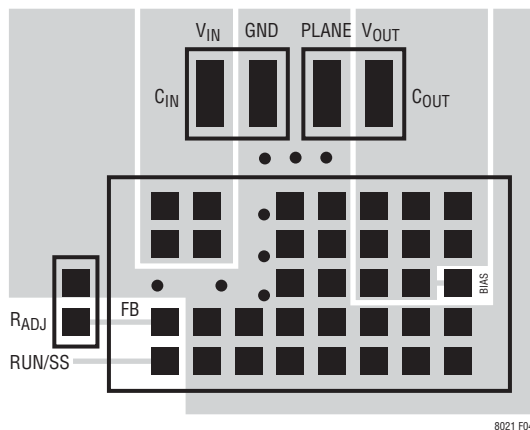

Figure 4. Layout Showing Suggested External Components, GND Plane and Thermal Vias

Hot-Plugging Safely

The small size, robustness and low impedance of ceramic capacitors make them an attractive option for the input bypass capacitor of LTM8021. However, these capacitors can cause problems if the LTM8021 is plugged into a live supply (see the Linear Technology Application Note 88 for a complete discussion). The low loss ceramic capacitor combined with stray inductance in series with the power source forms an under damped tank circuit, and the voltage at the V_{IN} pin of the LTM8021 can ring to twice the nominal input voltage, possibly exceeding the LTM8021's rating and damaging the part. If the input supply is poorly controlled or the user will be plugging the LTM8021 into an energized supply, the input network should be designed to prevent this overshoot. Figure 5 shows the waveforms that result when an LTM8021 circuit is connected to a 24V supply through six feet of 24-gauge twisted pair. The first plot is the response with a 2.2 μ F ceramic capacitor at the input. The input voltage rings as high as 35V and the input current peaks at 20A. One method of damping the tank circuit is to add another capacitor with a series resistor to the circuit. In Figure 5b an aluminum electrolytic capacitor has been added. This capacitor's high equivalent series resistance damps the circuit and eliminates the voltage overshoot. The extra capacitor improves low frequency ripple filtering and can slightly improve the efficiency of the circuit, though it is likely to be the largest component in the circuit. An alternative solution is shown in Figure 5c. A 0.7 Ω resistor is added in series with the input to eliminate the voltage overshoot (it also reduces the peak input current). A 0.1 μ F capacitor improves high frequency filtering. This solution is smaller and less expensive than the electrolytic capacitor. For high input voltages its impact on efficiency is minor, reducing efficiency less than one-half percent for a 5V output at full load operating from 24V.

APPLICATIONS INFORMATION

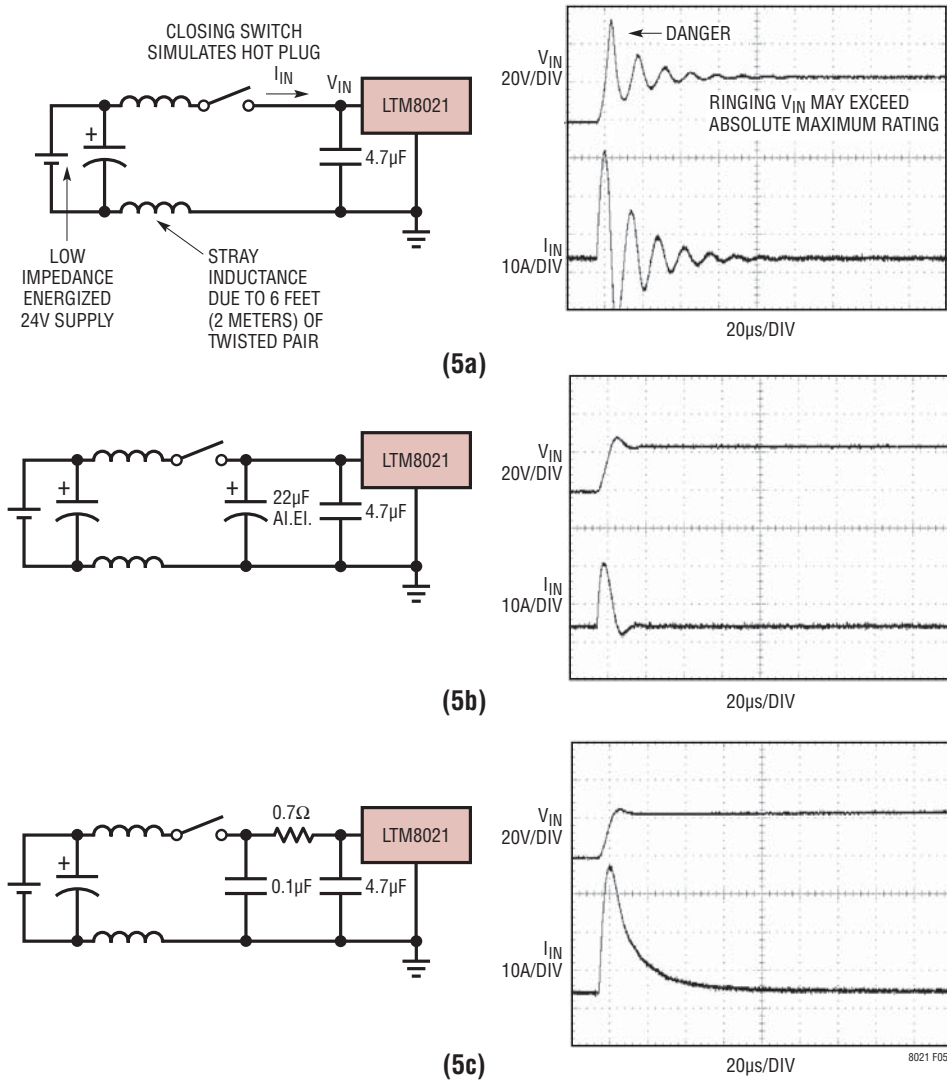

Figure 5. Ensures Reliable Operation When the LTM8021 is Connected to a Live Supply

High Temperature Considerations

The die temperature of the LTM8021 must be lower than the maximum rating of 125°C, so care should be taken in the layout of the circuit to ensure good heat sinking of the LTM8021. To estimate the junction temperature, approximate the power dissipation within the LTM8021 by applying the typical efficiency stated in this data sheet to the desired output power, or, if one has an actual module, by taking a power measurement. Then, calculate the temperature rise of the LTM8021 junction above the surface of the printed circuit board by multiplying the module's

power dissipation by the thermal resistance. The actual thermal resistance of the LTM8021 to the printed circuit board depends on the layout of the circuit board, but the thermal resistance given in the Pin Configuration, which is based upon a 40.3cm² 4-layer FR4 PC board, can be used as a guide.

Finally, be aware that at high ambient temperatures the internal Schottky diode will have significant leakage current (see the Typical Performance Characteristics) increasing the quiescent current of the LTM8021.

TYPICAL APPLICATIONS

0.8V Step-Down Converter

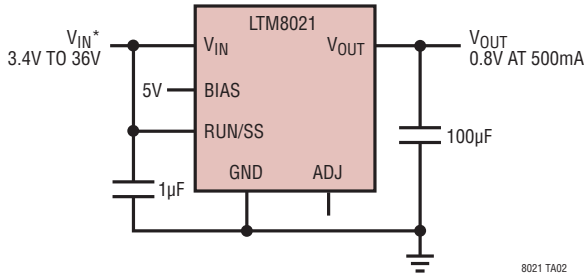

8021 TA02

*RUNNING VOLTAGE RANGE. PLEASE REFER TO THE APPLICATIONS INFORMATION SECTION FOR START-UP DETAILS.

1.8V Step-Down Converter

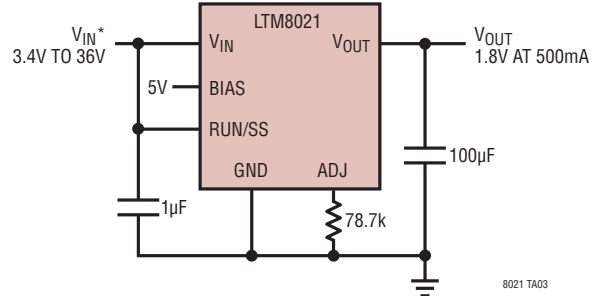

8021 TA03

*RUNNING VOLTAGE RANGE. PLEASE REFER TO THE APPLICATIONS INFORMATION SECTION FOR START-UP DETAILS.

5V Step-Down Converter

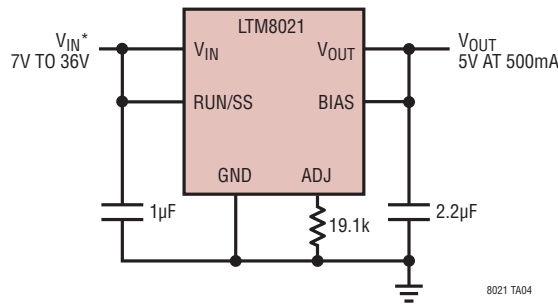

8021 TA04

*RUNNING VOLTAGE RANGE. PLEASE REFER TO THE APPLICATIONS INFORMATION SECTION FOR START-UP DETAILS.

-5V Positive-to-Negative Converter

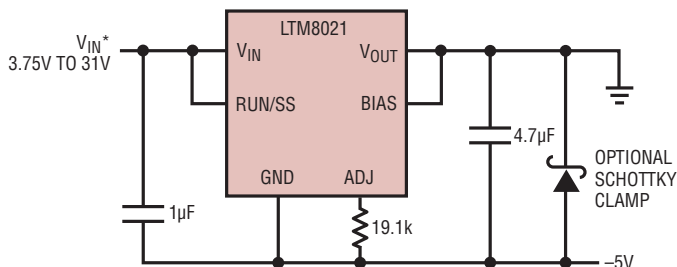

8021 TA05

*RUNNING VOLTAGE RANGE. PLEASE REFER TO THE APPLICATIONS INFORMATION SECTION FOR START-UP DETAILS.

Load Current vs Input Voltage

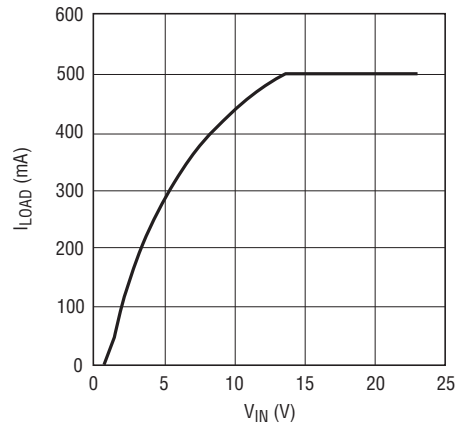

8021 TA05b

PACKAGE DESCRIPTION

LGA Package
35-Lead (11.25mm × 6.25mm × 2.82mm)
 (Reference LTC DWG # 05-08-1805 Rev A)

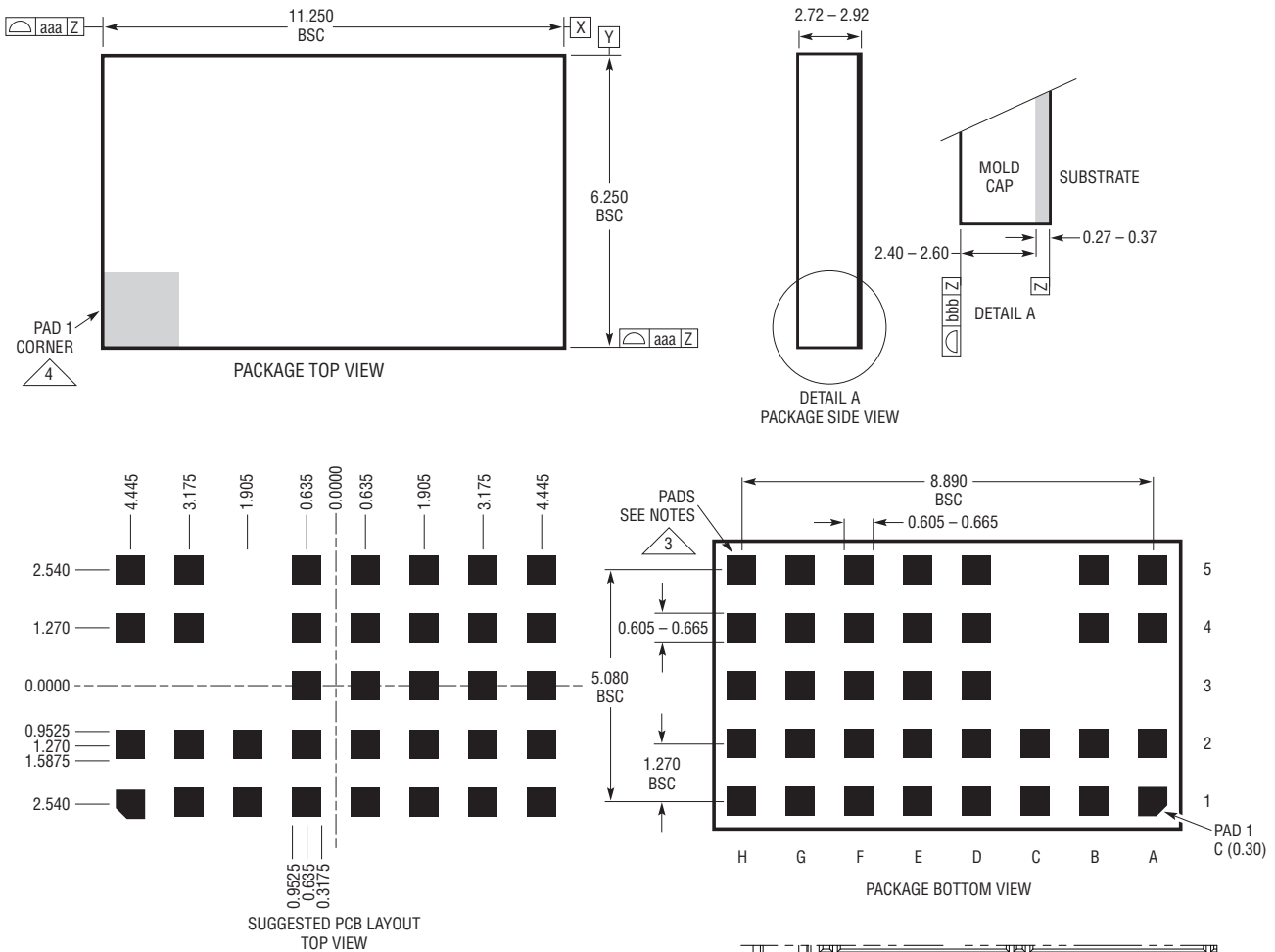

NOTES:

1. DIMENSIONING AND TOLERANCING PER ASME Y14.5M-1994

2. ALL DIMENSIONS ARE IN MILLIMETERS

3 LAND DESIGNATION PER JESD MO-222, SPP-010 AND SPP-020

4 DETAILS OF PAD #1 IDENTIFIER ARE OPTIONAL, BUT MUST BE LOCATED WITHIN THE ZONE INDICATED. THE PAD #1 IDENTIFIER MAY BE EITHER A MOLD OR A MARKED FEATURE

5. PRIMARY DATUM -Z- IS SEATING PLANE

6. THE TOTAL NUMBER OF PADS: 35

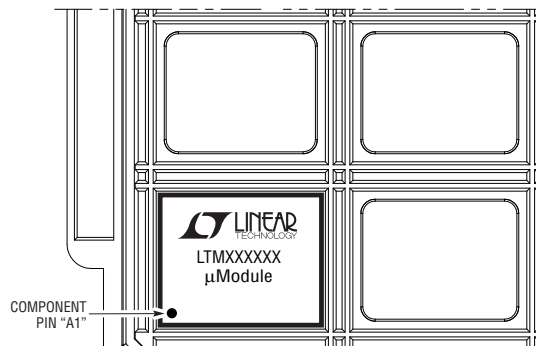

PACKAGE DESCRIPTION

LTM8021 Pinout (Sorted by Pin Number)

PIN	SIGNAL DESCRIPTION
A1	RUN/SS
A2	ADJ
A4	V _{IN}
A5	V _{IN}
B1	GND
B2	GND
B4	V _{IN}
B5	V _{IN}
C1	GND
C2	GND
D1	GND
D2	GND
D3	GND
D4	GND
D5	GND
E1	GND
E2	GND
E3	GND
E4	GND
E5	GND
F1	GND
F2	GND
F3	V _{OUT}
F4	V _{OUT}
F5	V _{OUT}
G1	GND
G2	GND
G3	V _{OUT}
G4	V _{OUT}
G5	V _{OUT}
H1	GND
H2	GND
H3	BIAS
H4	V _{OUT}
H5	V _{OUT}

TYPICAL APPLICATION

3.3V Step-Down Converter

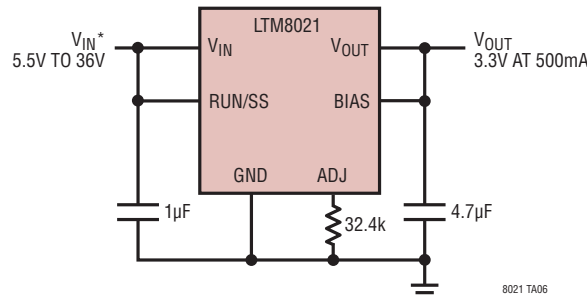

*RUNNING VOLTAGE RANGE. PLEASE REFER TO THE APPLICATIONS INFORMATION SECTION FOR START-UP DETAILS.

8021 TA06

RELATED PARTS

PART NUMBER	DESCRIPTION	COMMENTS
LTM4600	10A DC/DC μ Module	Basic 10A DC/DC μ Module, 15mm \times 15mm \times 2.8mm LGA
LTM4600HVMPV	Military Plastic 10A DC/DC μ Module	-55°C to 125°C Operation, 15mm \times 15mm \times 2.8mm LGA
LTM4601/ LTM4601A	12A DC/DC μ Module with PLL, Output Tracking/Margining and Remote Sensing	Synchronizable, PolyPhase [®] Operation, LTM4601-1 Version Has No Remote Sensing
LTM4602	6A DC/DC μ Module	Pin-Compatible with the LTM4600
LTM4603	6A DC/DC μ Module with PLL and Output Tracking/Margining and Remote Sensing	Synchronizable, PolyPhase Operation, LTM4603-1 Version Has No Remote Sensing, Pin-Compatible with the LTM4601
LTM4604	4A Low V_{IN} DC/DC μ Module	$2.375V \leq V_{IN} \leq 5V$, $0.8V \leq V_{OUT} \leq 5V$, 9mm \times 15mm \times 2.3mm LGA
LTM4605	5A to 12A Buck-Boost μ Module	High Efficiency, Adjustable Frequency, $4.5V \leq V_{IN} \leq 20V$, $0.8V \leq V_{OUT} \leq 16V$, 15mm \times 15mm \times 2.8mm
LTM4607	5A to 12A Buck-Boost μ Module	High Efficiency, Adjustable Frequency, $4.5V \leq V_{IN} \leq 36V$, $0.8V \leq V_{OUT} \leq 25V$, 15mm \times 15mm \times 2.8mm
LTM4608	8A Low V_{IN} DC/DC μ Module	$2.375V \leq V_{IN} \leq 5V$, $0.8V \leq V_{OUT} \leq 5V$, 9mm \times 15mm \times 2.8mm LGA
LTM8020	36V, 200mA DC/DC μ Module	$4V \leq V_{IN} \leq 36V$, $1.25V \leq V_{OUT} \leq 5V$, 6.25mm \times 6.25mm \times 2.3mm LGA
LTM8022	1A, 36V DC/DC μ Module	Adjustable Frequency, $0.8V \leq V_{OUT} \leq 5V$, 11.25mm \times 9mm \times 2.82mm, Pin-Compatible to the LTM8023
LTM8023	2A, 36V DC/DC μ Module	Adjustable Frequency, $0.8V \leq V_{OUT} \leq 5V$, 11.25mm \times 9mm \times 2.82mm, Pin-Compatible to the LTM8022

PolyPhase is a trademark of Linear Technology Corporation